



A NEW MAIN ROTOR HUB

FOR THE AS 332 SUPER PUMA

BY

R. MOUILLE

C. BIETENHADER

SOCIETE NATIONALE INDUSTRIELLE AEROSPATIALE

HELICOPTER DIVISION

MARIGNANE, FRANCE

TENTH EUROPEAN ROTORCRAFT FORUM

AUGUST 28 – 31, 1984 – THE HAGUE, THE NETHERLANDS

A NEW MAIN ROTOR HUB FOR THE AS 332 SUPER-PUMA

by
René MOUILLE
and
Claude BIETENHADER

AEROSPATIALE, MARIGNANE - 13725 MARIGNANE Cedex

ABSTRACT

Developed from the Starflex rotor head with a view to reducing the size and drag, the Spheriflex rotor head is of a new, particularly light, and economical design which, in terms of progress, compares with the Starflex as the latter compares with conventional articulated hubs.

It provides a considerable reduction in drag, which is an essential requirement in the design of fast, next generation helicopters.

In the case of the metal version made for the AS 332 SUPER PUMA, which has to be interchangeable with the production rotor head, and without modifications of the upper aircraft cowlings, gains are less marked, particularly with respect to drag. A weight reduction of about 65 kg is nevertheless obtained, the number of parts is reduced by 3, and safety is considerably improved owing particularly to the redundancy in the central part of the hub which gives it fail-safe properties.

This new rotor head design should help reduce the AS 332 SUPER-PUMA operating costs significantly.

1 - INTRODUCTION

Issuing new rotor hub concepts with a view to reducing weight, cost and maintenance, and improving safety and reliability, has always been one of the major concerns of the AEROSPATIALE Helicopter Division.

A number of different types of rotor head have been tested in the past, some of which have been used on production aircraft.

The conventional articulated hubs of the ALOUETTE, SUPER FRELON and PUMA were followed by other concepts.

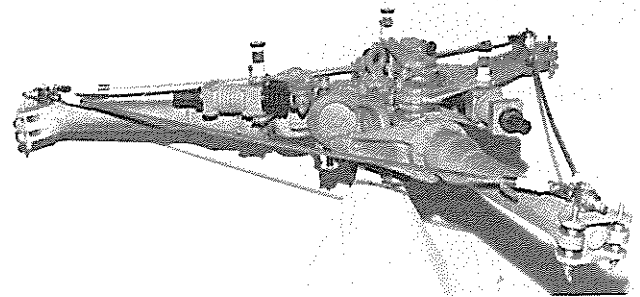

ALOUETTE III. M.R.H.

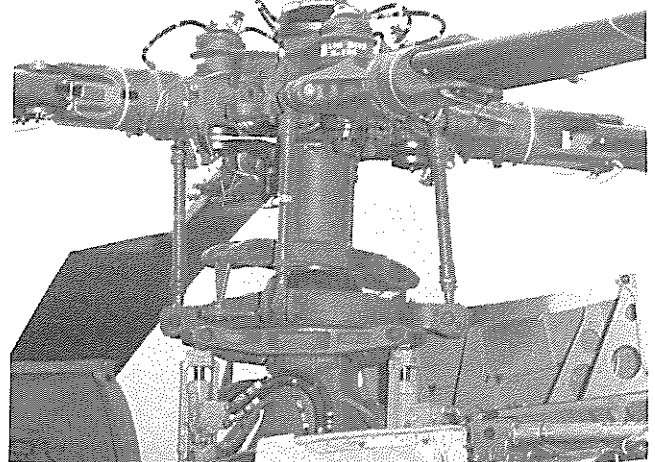

SA 330 "PUMA" MAIN ROTOR HEAD

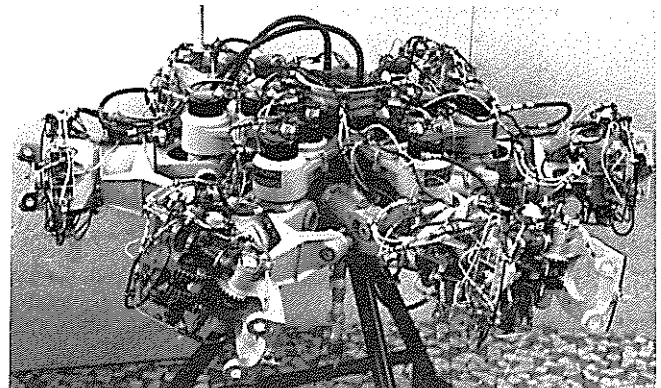

SUPER FRELON M.R.H.

- The NAT rotor head, the first to be fitted with visco-elastic dampers, fitted to production GAZELLE and single engine SA 360 DAUPHIN helicopters.

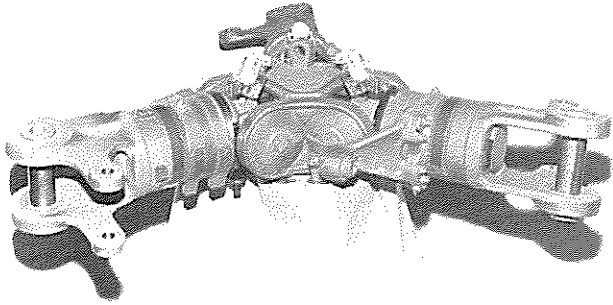

GAZELLE M.R.H. (NAT)

- The Biflex and Triflex experimental rotor heads, tested on the GAZELLE.

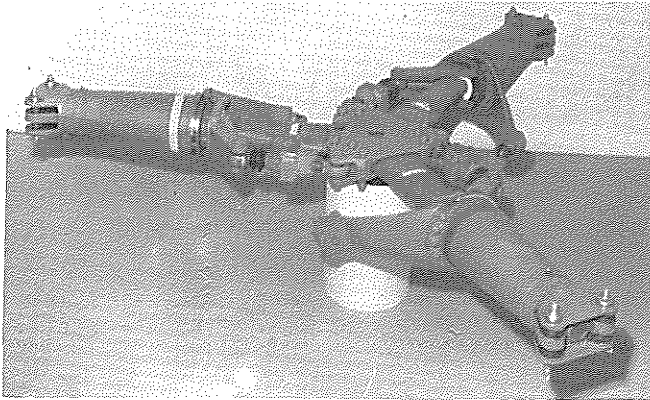

" BIFLEX " ROTOR HEAD

- The MIR hub (MBB concept) tested on the ALOUETTE and GAZELLE.

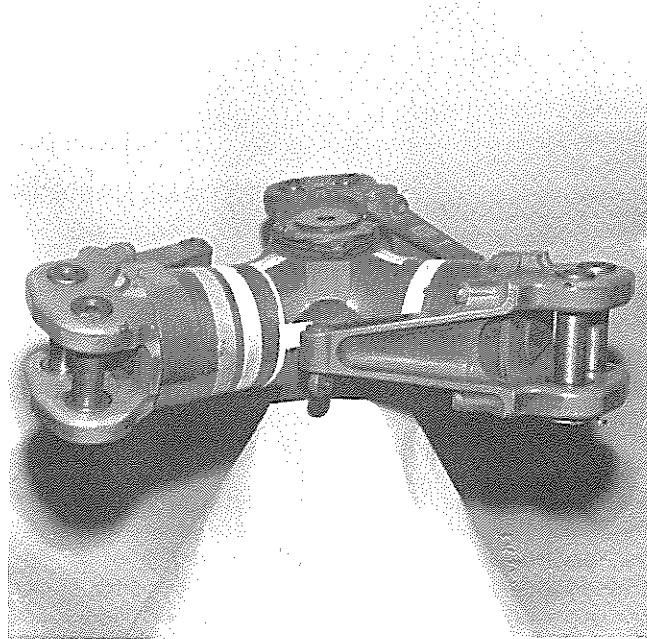

INTEGRAL RIGID ROTOR HEAD "MIR "

- The Starflex rotor head made of composite materials, fitted to production AS 350 and AS 355 ECUREUIL and to SA 365 C, N, G twin engine DAUPHIN.

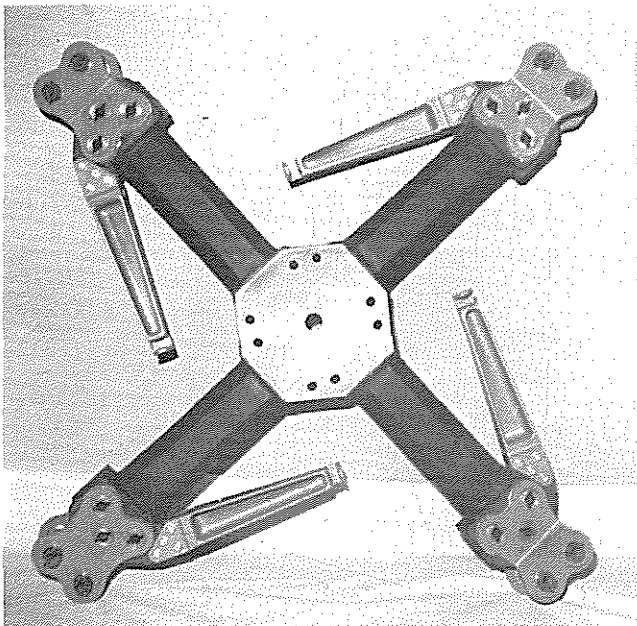

" TRIFLEX " ROTOR HEAD

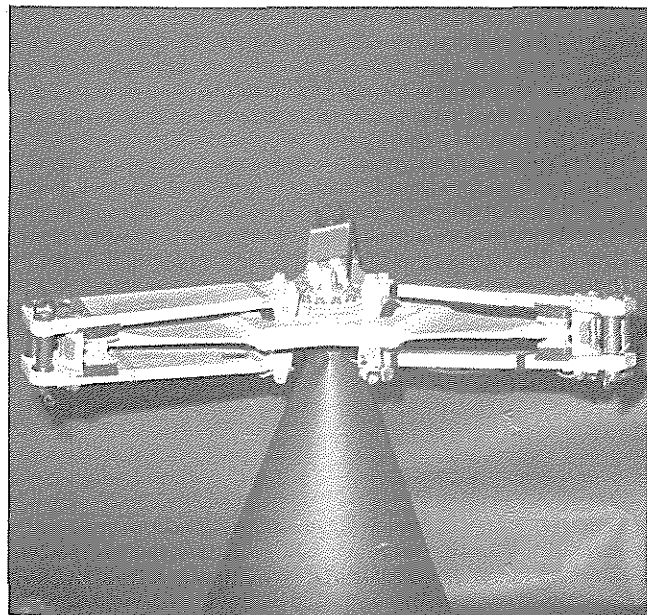

" STARFLEX " ROTOR HEAD

The Starflex has proved to be a particularly successful solution with respect to weight, cost and fail-safe properties. Its disadvantage is its size which gives an increase in drag, as was revealed on the DAUPHIN when it was fitted to replace the NAT rotor head (Speed drop : 7 Km/h).

STARFLEX AS 350

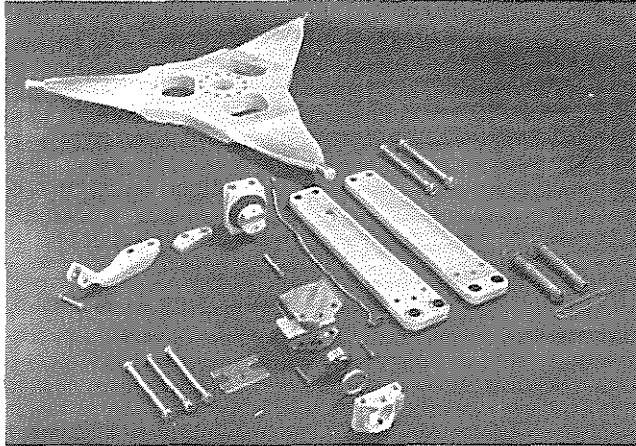

SA 318 HINGED

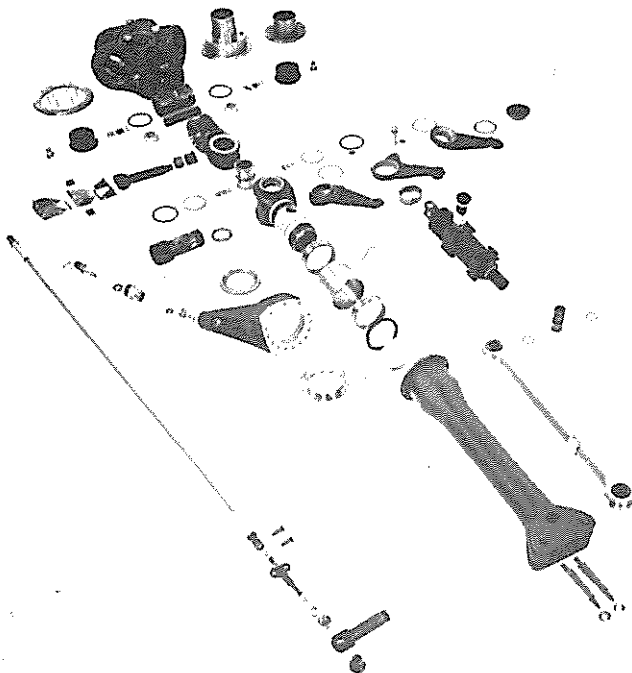

WEIGHT SAVING : 45 %
COST SAVING : 75 %

NUMBER OF PARTS		AS 350	SA 318
TOTAL		70	377
OF WHICH	BEARINGS	0	30
	SEALS	0	45
	LUBRIFICATORS	0	22
	SELF-LUB. BEARINGS	3	0
	LAMINATED BEARINGS	3	0

COMPARISON BETWEEN MAIN ROTOR HEADS

2 - FROM STARFLEX TO SPHERIFLEX

The Spheriflex rotor head can be considered as a development of the Starflex, and retains its basic features : laminated elastomer thrust bearing and visco-elastic damper.

To reduce the size of the Starflex rotor head, the blade attachment must be brought closer to the hub center.

This is best achieved by attaching the blade directly to the thrust bearing by means of a yoke shaped blade root, and eliminating the flexible arms of the Starflex star. The visco-elastic dampers are then positioned laterally between the hub and the blade.

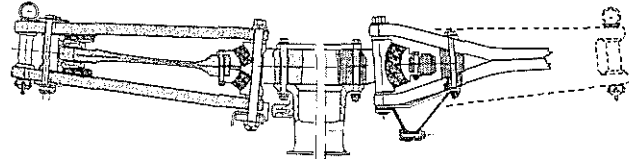

STARFLEX - SPHERIFLEX EVOLUTION

Since the rotor head will have no more flexible arms, the material used for its manufacture can be chosen freely. The hub can then be made integral with the rotor shaft, thereby eliminating all problems likely to occur at the hub/mast connection (fretting corrosion, loss of bolt torque loading, etc ...). The resulting hub-mast is made of metal, but the fail-safe properties of a composite hub are recovered with a composite winding of the upper plate, giving redundant resistance to centrifugal forces and to shear loads due to blade flapping.

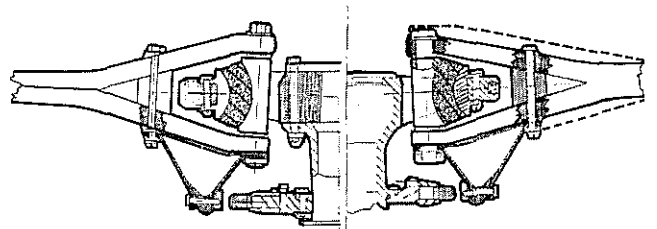

INTEGRATION OF HUB IN MAST

By replacing the splines at the base of the mast with a large diameter bolted joint it could be possible to make the hub/mast from titanium, and even from graphite composite material after further development work.

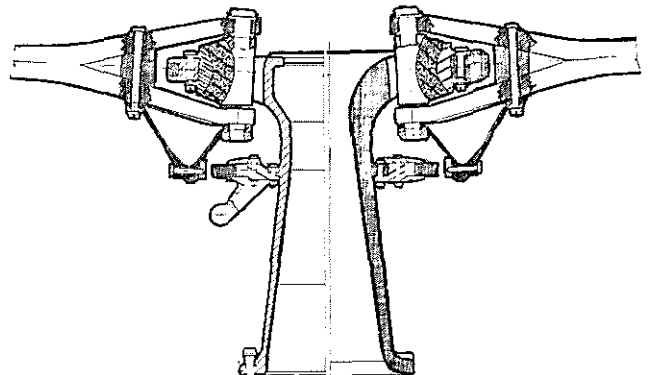

MAST HUB MATERIAL CHOICE =
STEEL TO TITANIUM OR GRAPHITE

The blade droop restrainer consists of a droop restrainer ring formed by a ring of graphite composite with steel surround. The composite blade horn can be housed in the blade root yoke.

This rotor head design is extremely simple since, apart from the blades and mast which incorporate the sleeves and the central part of the hub, there are no more structural parts ; the typical components such as thrust bearings, visco-elastic dampers, blade horns and droop restrainers only remain.

The weight saved with respect to the Starflex rotor head is equivalent to that achieved when the latter is compared to the conventional articulated rotor head, and costs are also considerably lower.

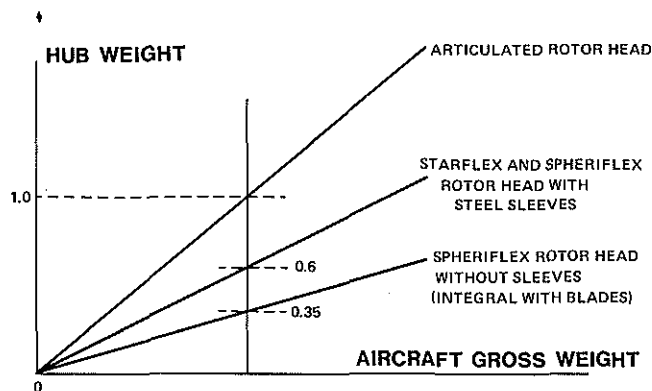

This type of rotor head appears as the lightest and most economical of all heads developed so far. Moreover, the small size of the hub, combined with redesigned upper aircraft cowlings, leads to a major reduction in drag. From wind tunnel tests on a DAUPHIN's model, **total aircraft drag could be reduced by 30 % in this way**, which means over 2/3 less drag from the Starflex rotor head itself. In addition, this reduction in drag means a smaller wake effect and improved stability in pitch and roll..

Limitation of flapping offset to around 4 % prevents excessive vibratory excitation at high speed. It also helps to reduce the drag by reducing nose-down moments on the fuselage, which allows the reduction of weight of the hub/mast and MGB-hub-mast assembly attachments to the structure.

By using visco-elastic dampers, the blade drag frequency can be adjusted to give correct ground resonance and air resonance behaviour.

All rotor head components are readily visible without dismantling for an easy «on condition» monitoring of the only components subjected to wear, i.e. the laminated elastomeric thrust bearing and the visco-elastic dampers.

3 – THE SPHERIFLEX ROTOR HEAD ON THE AS 332 SUPER PUMA

The AS 332 SUPER-PUMA, currently fitted with a conventional rotor head articulated on lubricated bearings, has been chosen as the first aircraft to be fitted with this new type of rotor head.

Special design constraints had to be followed in view of future development prospects for this helicopter, and to ensure compatibility with the existing aircraft :

- the rotor head must be able to take the SUPER-PUMA production blades with no change in the rotor diameter. For this reason, a sleeve must be fitted between the thrust bearing and blade attachment area
- the rotor head must be designed to support 15 % increase in blade weight
- the design must be such as to allow installation of an automatic blade folding system by simply modifying the sleeve. Easiest conversion into a hydraulic folding system will be achieved by using a tubular metal sleeve
- dynamic characteristics and performance of the rotor head must match those of the helicopter.

The same overall objectives were, of course, retained ; improved safety and reliability, reduced weight and cost, to help improve SUPER-PUMA competitiveness.

DESCRIPTION OF THE AS 332 SPHERIFLEX ROTOR HEAD

The AS 332 Spheriflex main rotor head consists of four main components :

The hub, integral with the mast, is a virtually circular plate made fail-safe by a band of unidirectional composite material (Kevlar). Cutouts machined in the plate house the thrust bearings. Four fittings between the cutouts are used for attaching the visco-elastic dampers.

The spherical thrust bearing, using the laminated elastomer technology, allows the blade to move in three ways (flapping, drag, incidence) and carry the centrifugal forces from blades to the hub.

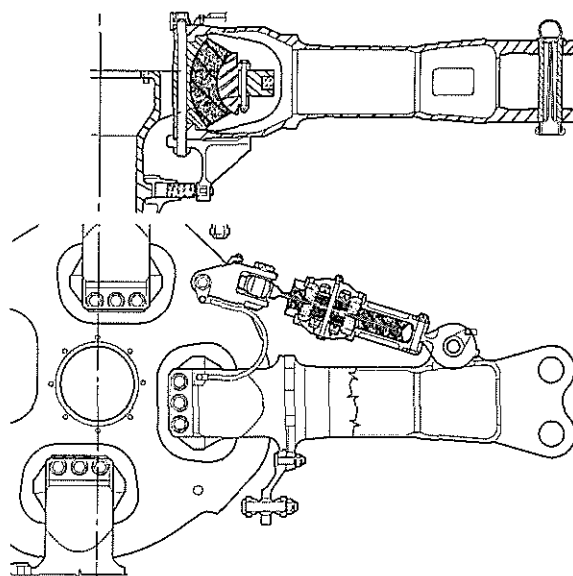

AS 332 SPHERIFLEX ROTOR HEAD

The sleeve is used to attach the blade to the thrust bearing and keep it the same distance from the hub center as on the production rotor head. Manual rearward folding of the four blades is therefore carried out in the same way as at present.

The visco-elastic damper connecting the hub to the sleeve provides stiffness and damping of drag movements through shear effect of two layers of visco-elastic elastomer. Extra damping is provided by an additional system, completely encased in this elastomer, consisting of two stacks of discs moving in relation to each other in a high viscosity polymer. The ends of each damper are articulated on ball joints which can easily be replaced.

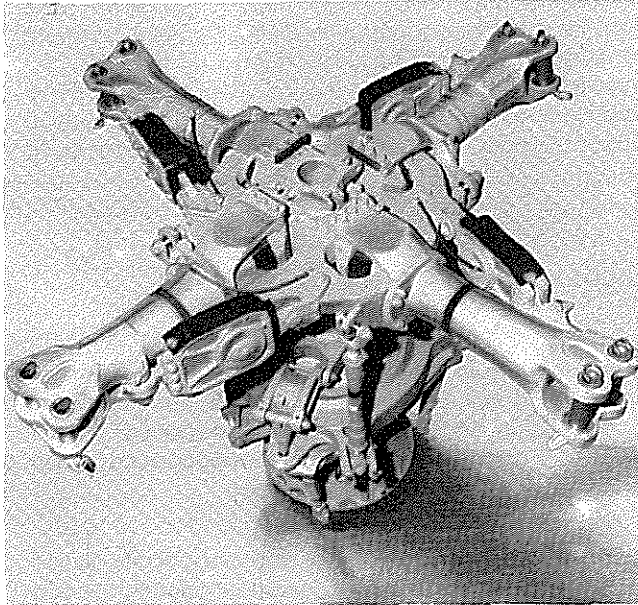

AS 332 - SPHERIFLEX . M.R.H.

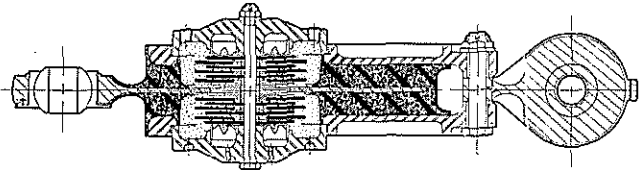

VISCO ELASTIC DAMPER

The blade horns bolted to the sleeves are connected to the control rods by self-lubricated ball joints.

A droop restrainer ring made from graphite-epoxy material with a steel surround takes the weight of the blades at rest via four bumpers fitted under the sleeves.

DEVELOPMENT

Patented in 1977, this type of rotor head was developed for the SUPER-PUMA as from November 1982. The first flight took place 13 months later in December 1983. The entire SUPER-PUMA flight envelope, and more, was covered in four months of flight tests :

- Gross weight increased to 9200 kg, with extreme CG positions
- Speed from - 30 kts to + 160 kts
- Altitude up to 13000 ft
- Load factor up to 2 g.

The general behaviour of the helicopter fitted with the Spheriflex rotor head is very satisfactory, equivalent to that with the production head, and even better as regards the vibration level and stability in rough air.

This can be explained by the similarity in the dynamic properties of the two rotor heads, the Spheriflex having some specific features.

	Production M.R.H.	Spheriflex M.R.H.
Flapping offset	3.7 %	3.4 %
Drag offset	3.4 %	3.4 %
$\Delta 3$ effect	0	8°
First drag mode	0.44R	0.43R

The small $\Delta 3$ effect results in an improved stability in rough air. The design of the visco-elastic damper is such that the position of the first drag mode can be modified easily if necessary, and the amount of damping needed can be adjusted accordingly.

For the AS 332, there is no significant gain in level flight speed since there is very little reduction in rotor head drag due to the requirement for interchangeability with the production head, although drag is 35 to 40 % less than that of the equivalent Starflex.

DIMENSIONING

Stresses in the main components, i.e. the hub and sleeve, have been calculated by the finite elements method and confirmed by photo-elastic tests.

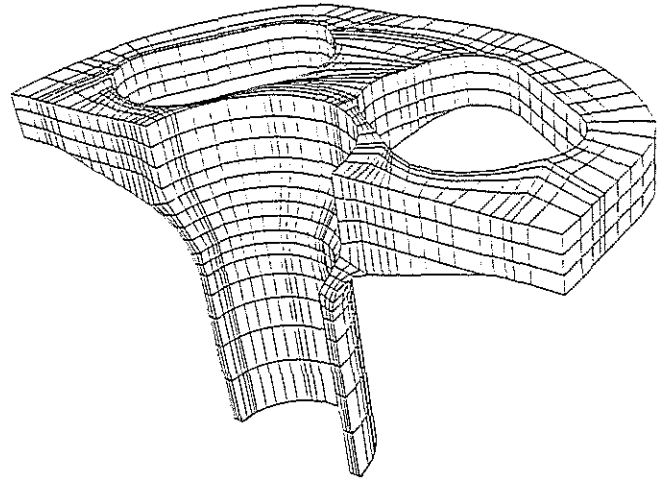

HUB - FINITE ELEMENTS MESH

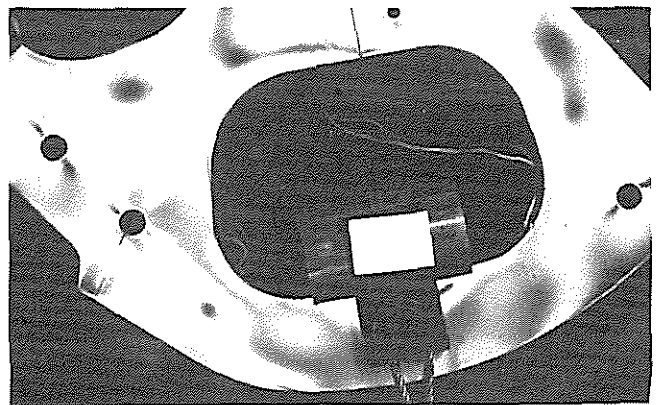

HUB BODY PHOTO - ELASTICITY

On the basis of measurements in flight and fatigue tests already carried out, an unlimited service life can be anticipated for both these vital parts.

The spherical thrust bearing has been dimensioned for at least 3000 hours' operating time, and this seems to be confirmed by initial test results. The operating time of the visco-elastic dampers should be the same, except for the attachment ball joints which are easily replaceable, and for which optimization laboratory tests are currently being carried out.

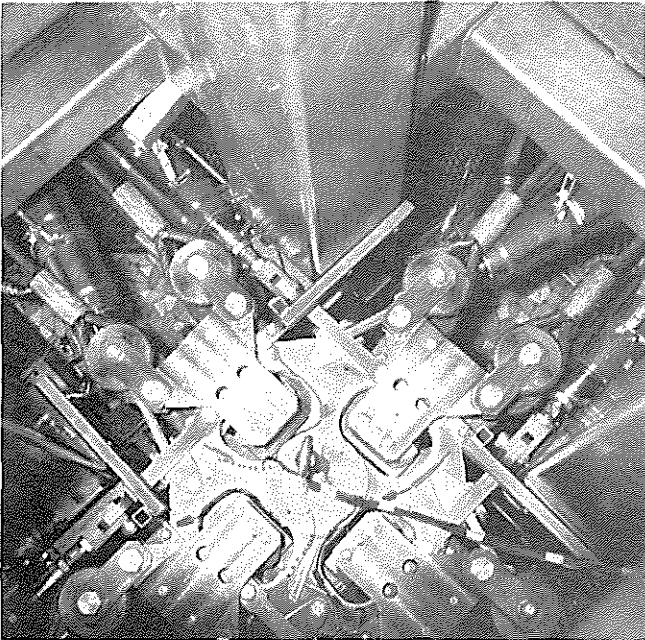

ROTOR HUB . FATIGUE TEST.

It must, however, be possible to detect any damage promptly. Every care has been taken to provide very easy access for checking all rotor head components without removal. The considerable reduction in the number of assemblies and components (three times less approximately), combined with the features indicated above, gives a much higher level of safety.

Considerable gains have also been obtained as regards reliability, which is synonymous with availability, and as regards maintenance, which is greatly facilitated by the simplicity of assemblies, ready access, and the elimination of special tools. Components can therefore be replaced in the field, without the need to return them to the works for overhaul.

DIRECT OPERATING COST

Expectations based on anticipated operating time figures and estimated maintenance times give the direct operating cost (D.O.C.) of the Spheriflex rotor head as being between 20 and 30 % of the D.O.C. for the rotor head currently fitted to the SUPER-PUMA production aircraft.

The increased payload owing to reduced aircraft weight must also be taken into account when calculating the cost per Kg/Km performed. Due to the specific constraints imposed, this saving in weight is not as high as it could be. Even so, it is 65 kg, which is 21 % of the total current rotor head weight. Furthermore, the manufacturing and assembly cost is reduced to 35 % of that of the production head. This also has a favourable effect on the aircraft operating cost.

SAFETY - RELIABILITY - MAINTENANCE

The more and more intensive and stringent operating conditions for helicopters in the civil sector, and the increasing demands for low vulnerability in the military sector, make it necessary to cover the effect of accidental or functional damage to the vital components.

Thus, in addition to adequate dimensioning to give unlimited service life to the main structural parts, particular attention has been paid to the following aspects :

- Making the hub fail-safe by means of a composite material surround, and making the sleeve fail-safe by multiple attachments
- Preventing development of fretting corrosion at critical points by systematically fitting anti-fretting barriers (wear plates, bushes, hard deposits, etc ..)

The use of elastomers in the thrust bearing and visco-elastic damper also gives a high degree of operational safety owing to the slow rate of deterioration and the elimination of any risk of seizure.

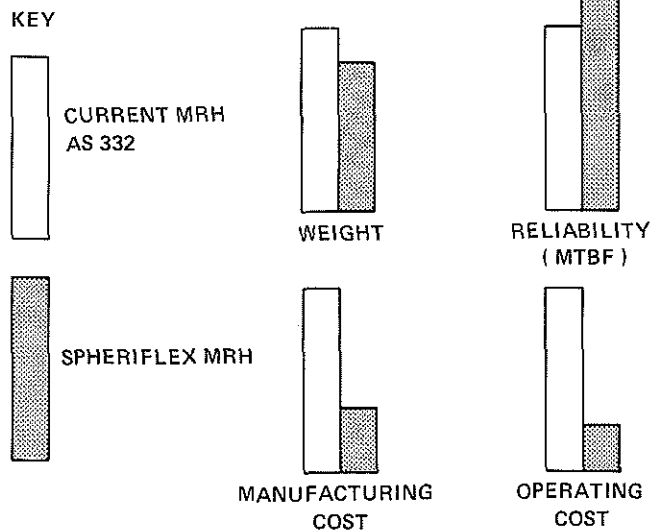

SAVING OBTAINED WITH SPHERIFLEX

4 – CONCLUSION

The Spheriflex rotor head concept, developed from the Starflex, represents significant progress in terms of weight cost, drag, safety, reliability and maintenance. When compared to other Aerospatiale experimental B.M.R. heads, this concept scores well in the same terms, with additional advantages regarding vibrations and stability.

It appears to be a very flexible concept from the technical and operational point of view, with low developer risk and cost.

When used on the AS 332 SUPER-PUMA and despite the specific design constraints, it results in improved aircraft behaviour in flight, in a weight saving of 65 kg, in a great safety and reliability, and reduced manufacturing and operating costs. This will lead to a considerable improvement in the aircraft's competitiveness.

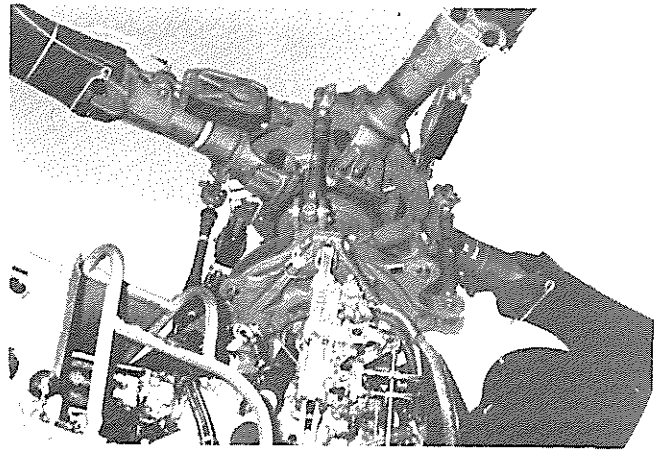

AS 332 FITTED WITH SPHERIFLEX M.R.H.