

NINTH EUROPEAN ROTORCRAFT FORUM

PAPER N° 30

SFENA TARGET SIGHT SYSTEM
FOR HELICOPTERS

M. DUBOIS
SFENA-VELIZY, FRANCE

S F E N A

Aérodrome de Villacoublay, B.P. 59
78141 Vélizy-Villacoublay Cédex - France

September 13/15, 1983

STRESA, ITALY

ASSOCIAZIONE INDUSTRIE AEROSPAZIALI
ASSOCIAZIONE ITALIANA DI AERONAUTICA ED ASTRONAUTICA

1 - INTRODUCTION

At the present time, SFENA is developing a range of head-up target sights based on a liquid crystal matrix and symbol generator.

The sights have been specially developed for use on helicopters, but can also be installed on other vehicles such as :

- Tactical support aircraft.
- Armored fighting vehicles.

Their main features are as follows :

- Compact size.
- Low cost with respect to display capability.

2 - SIGHT UNITS

2-1- General

The current range of Target Sight Systems consists of :

- Two sight units : VIMES and VIMEC which can be associated with the following as required :
 - 1 symbol generation unit.
 - 1 fire control computer.

2-1-1- Symbol Generator

The symbology is generated by means of a liquid crystal matrix operating in transmissive mode. The advantages of this display technique are :

- Compact size of the matrix and its associated electronics.
- The possibilities of this type of symbology, which mean that these sight systems represent the lower end of the range of cathode ray tube displays but can be procured at much lower cost.

The matrix consists of 120 rows and 120 columns, giving a definition of 144,000 dots within the field of view.

Size of one dot : 1.4mrd x 1.4 mrd.

Matrix quantification : 2.5 mrd.

Symbology displacement rate : 20 Hz.

The symbology is transmitted to the matrix control electronics via a serial digital line.

2-1-2- Light Source

The light source for the sight unit is provided by two high-output incandescent bulbs placed side by side in a light-concentrating optical system.

The lamps can be dimmed completely or adjusted to emit in the whole visible spectrum. They are ventilated.

2-1-3- Optics

An optical system formed by wide-angle lenses contains the LCD matrix in its focal plane and projects the symbology to be displayed to infinity.

The layout of the three assemblies - light source, LCD matrix and optics - is similar to that found in a conventional slide projector :

Digital signal.

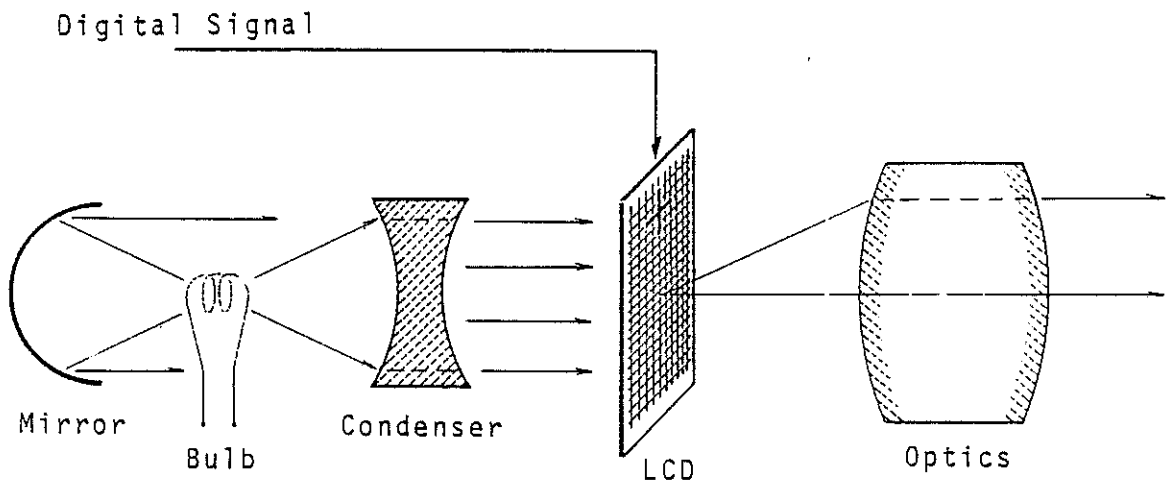

2-1-4- Attachment

The sight unit is attached to the cockpit roof by means of a harmonizable mount.

The compact size of the sight unit means that it can be adjusted in height without losing this harmonization.

2-1-5- Night Firing

The system is suitable for night firing when the pilot uses 2nd or 3rd generation light-intensifying goggles.

2-1-6- View Recording

The view can be recorded by means of a film or video camera designed for this purpose.

2-2- Sight Unit VIMES (K177)

Particular features :

- Field of view : circle with a diameter of 300 mrd.
- Optical system formed by 6 lenses.
- Optical aperture : 110mm at last lens in optical system.
- Maximum luminous flux : 800 lumen capable of reaching 2000 lumen.
- Weight : 5.5 kg.
- Power consumption : 1 Watt for 20 lumen at 28VDC.
- Combiner : optically neutral semi-reflective glass :
 - . Outside world transmission factor = 60%
 - . Symbology transmission factor = 40%

The combiner can be retracted forwards when the sight is not in use.

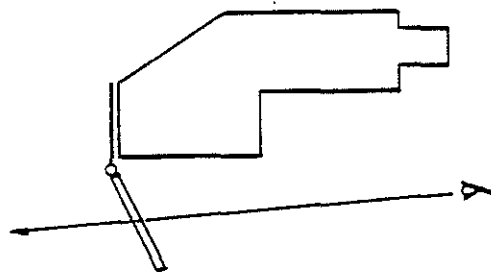

In use

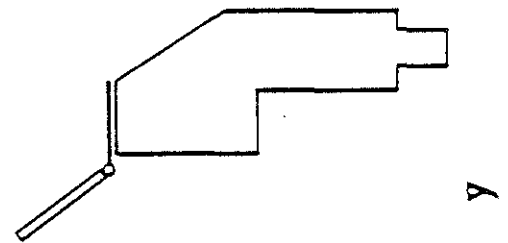

Not in use

For greater pilot comfort, it is possible to mount the combiner on a rack. In this case, the optical axis can be suited to the height of the pilot.

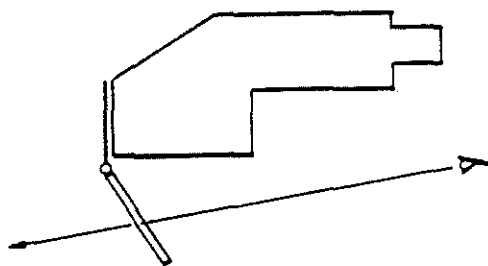

Tall pilot

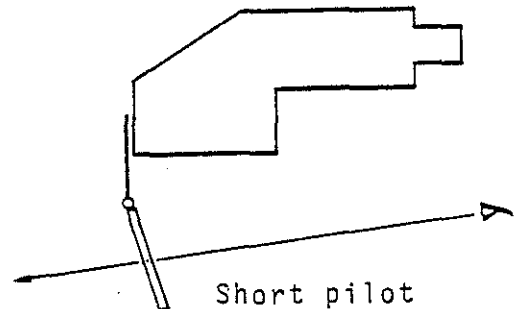

Short pilot

For various types of application, it is possible to orient the main sight axis in different directions while keeping the combiner correctly positioned with respect to the pilot.

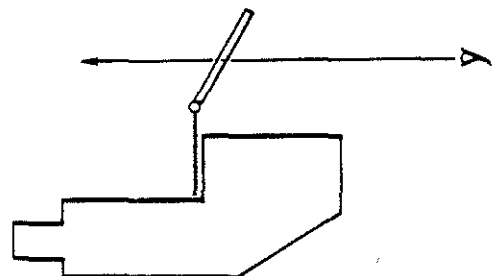
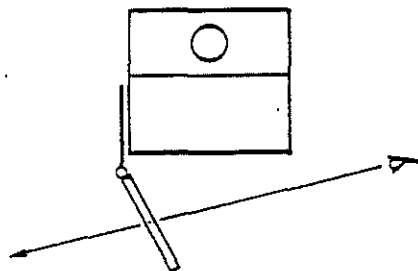

The adaptation of the symbology is performed by the symbol generation unit.

SCHEMATIC REPRESENTATION OF SFENA HEAD-UP DISPLAY K177

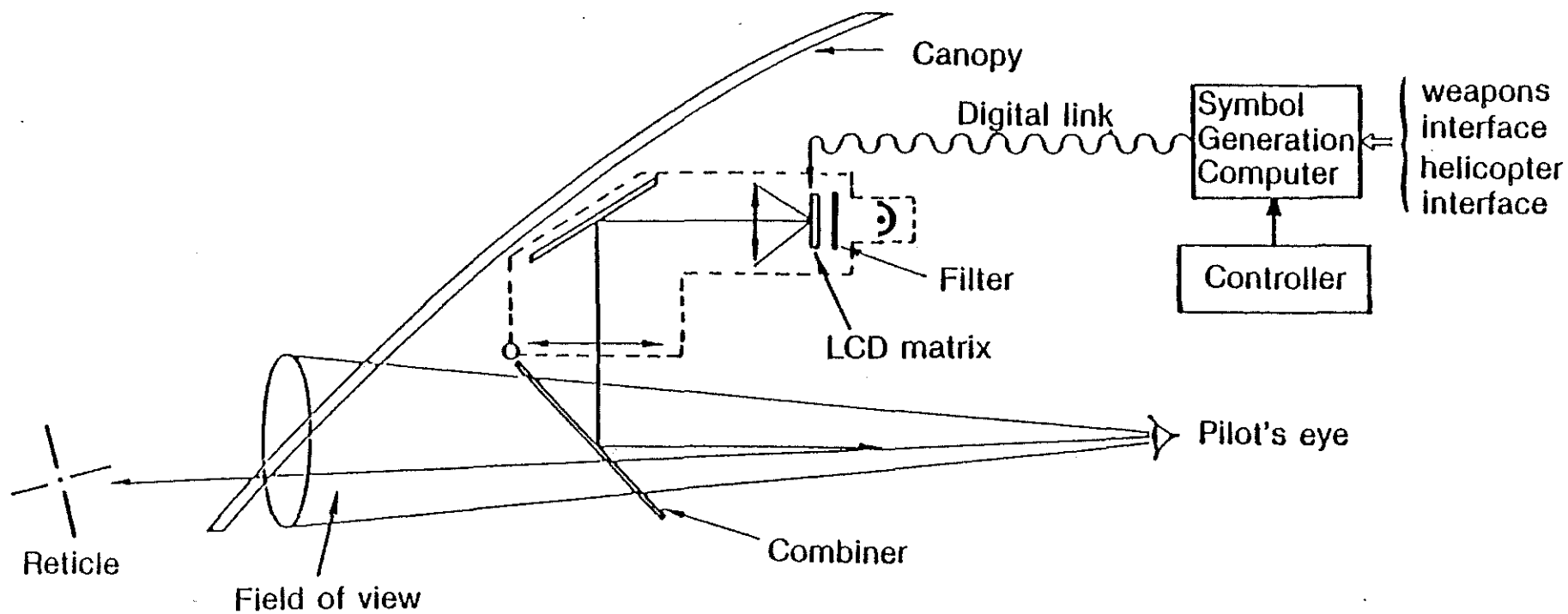

2-3- Sight Unit VIMEC (K209)

Particular features :

- Field of view : square, 260 mrd per side.
- Optical system formed by a semi-reflective glass oriented towards the front and a combiner consisting of two concave lenses separated by a semi-reflective surface.
- Optical aperture : 110 mm at the combiner.
- Maximum luminous flux : 2000 lumen.
- Power consumption : 1 Watt for 20 lumen at 28VDC.
- Combiner : directly integrated in power optics, which has the effect of increasing the pilot's instantaneous field of view.
- Outside world transmission factor : 30%.
- Symbology transmission factor : 12%.

The very compact form of this sight means that it can be installed in the cockpit of practically any aircraft or helicopter.

SCHEMATIC REPRESENTATION OF SFENA HEAD-UP DISPLAY K209

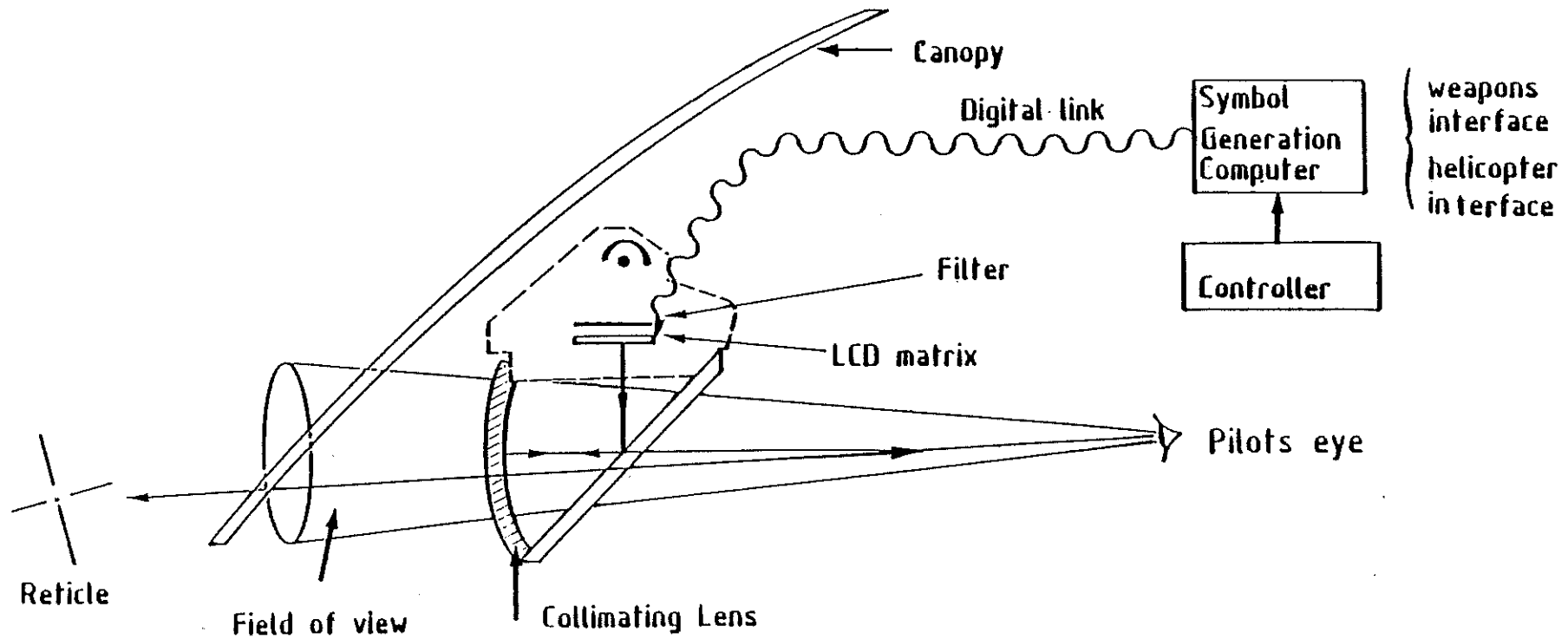

3- SYMBOL GENERATION UNIT

This consists of a symbol generator controlled by a microprocessor-based printed circuit board. It makes it possible to acquire external data coming from the weapons controller or weapons systems :

- Firing mode.
- Reticle positioning.
- Firing range for display.

Weight : 1.7 kg.

Power supply : 28 VDC (10 W).

8 analog inputs.

24 logic inputs.

4- FIRE CONTROL COMPUTER

This is a high-capacity computer containing a symbol generator.

It is able to acquire all types of signals required for fire control.

Computer format : 4 MCU (1/2 ATR short)..

Weight : 5.5 kg.

Power supply : 28 VDC (40 W).

Gunnery Fire Control

This has two firing modes :

- Non-predictive mode.

The displayed reticle represents the track, at the gun/target distance, of a shell fired at the present moment.

- Predictive mode (Air-to-air and air-to-ground)

In the target acquisition phase, the pilot aligns the line of sight and the target. In the actual firing phase, the movement of the target is taken into account through the angular rates of the firing helicopter.

The pilot holds the line of sight constantly on the target. At the same time, the line of sight is offset in the opposite direction to the target-movement prediction value, so that the shell hits the target after it has covered a distance corresponding to the flight time of the shell.

5- SIGHT SYSTEMS

Four sight system are usable with the above-mentioned units. Two of them are undergoing experiments.

5-1- US Army Experiment

A sight system has been undergoing experiments since the end of 1982 on a U.S. Army OH58 helicopter.

This system consists of :

- 1 sight unit VIMES.
- 1 symbol generation unit.

The following symbologies are currently undergoing experiments in missile mode.

5-2- Gazelle-Canon experiment

A gunnery fire control system will be evaluated during the second half of 1983 at the French Flight Test Center.

This system consists of :

- 1 sight unit VIMEC.
- 1 Fire control computer.

The proposed symbologies are as follows.

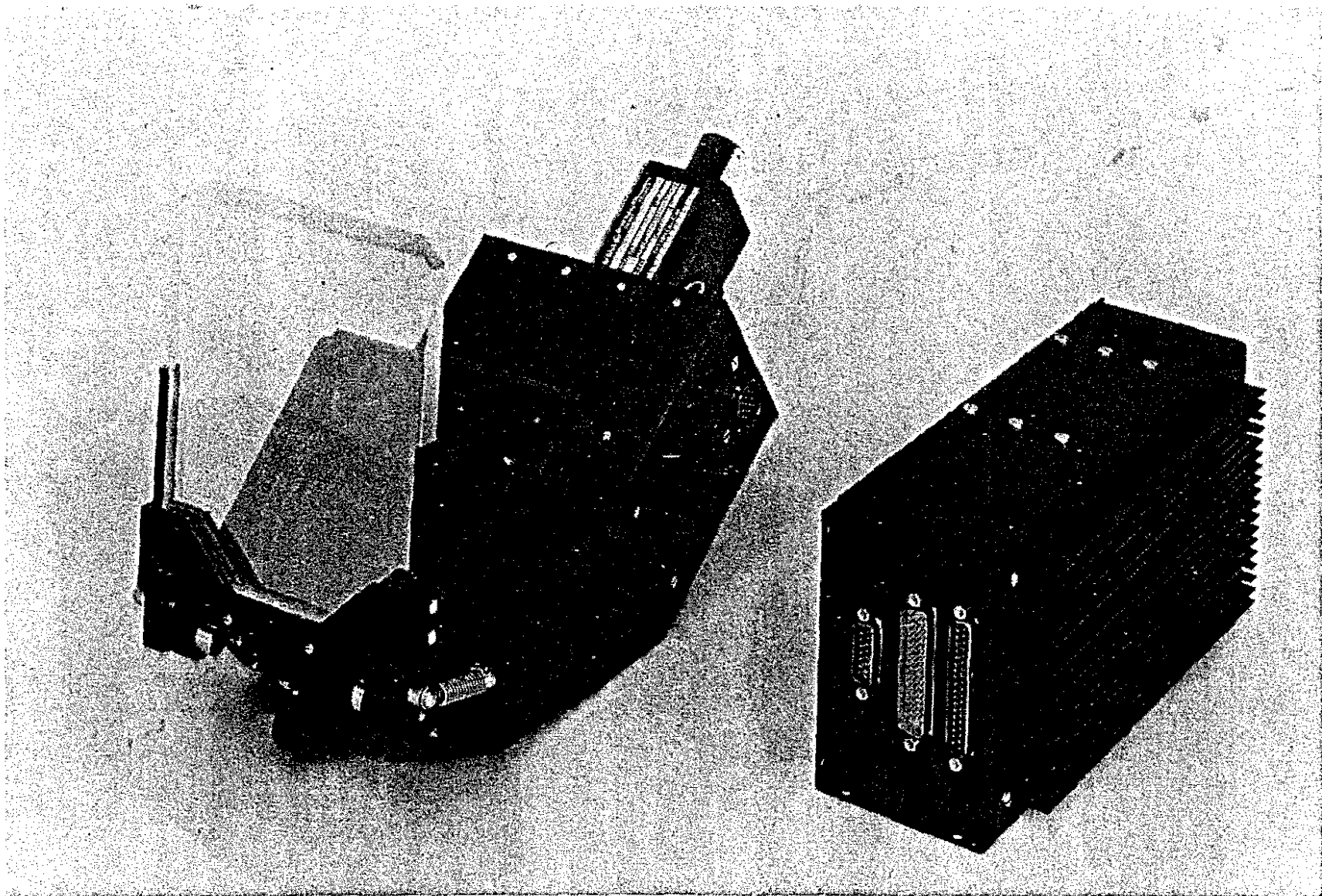

SIGHT SYSTEM - MINIMUM CONFIGURATION

TARGET SIGHT WITH VIMEC

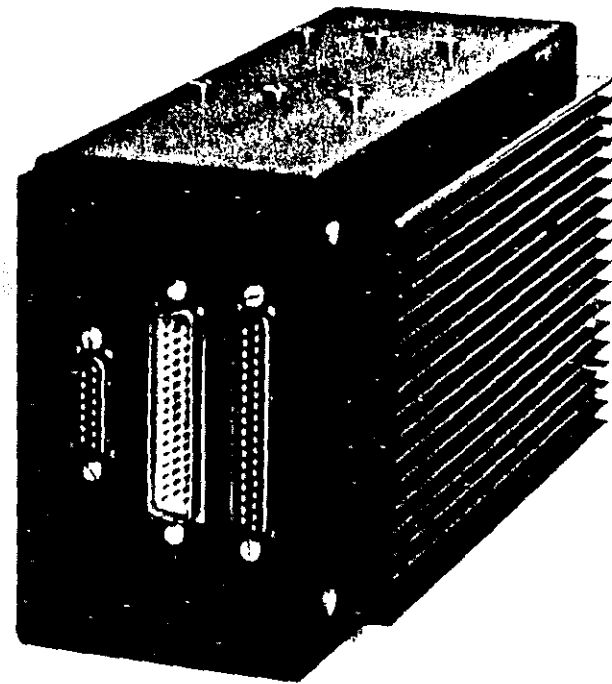
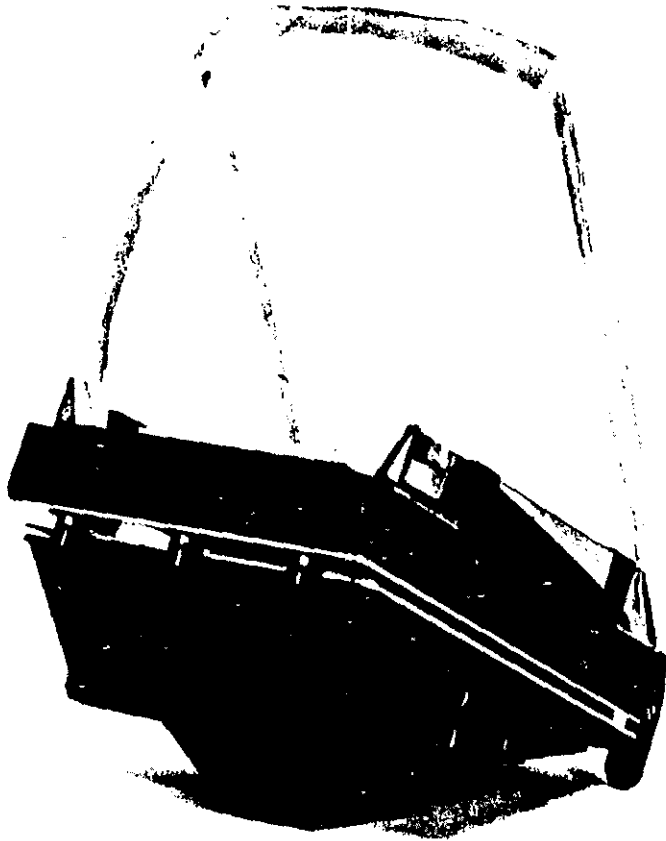

GUN/ROCKET FIRE

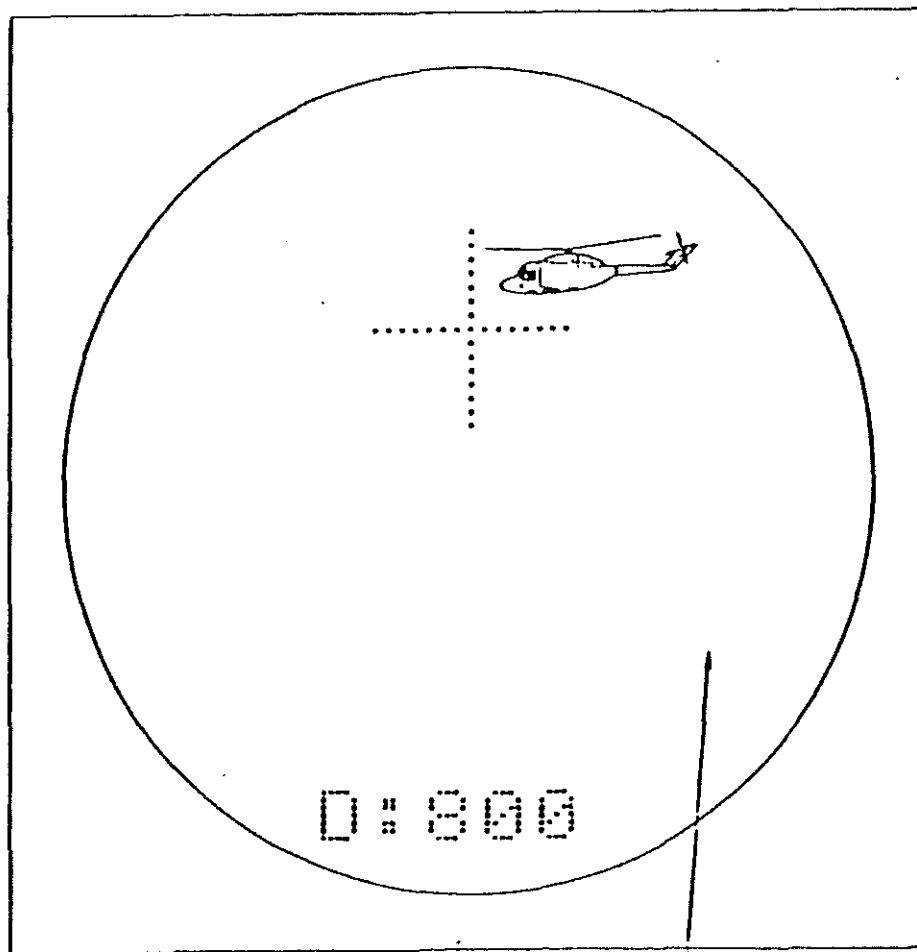

Total field : 300 mrd

SELF-GUIDED MISSILE FIRE

$\theta = 2^\circ$

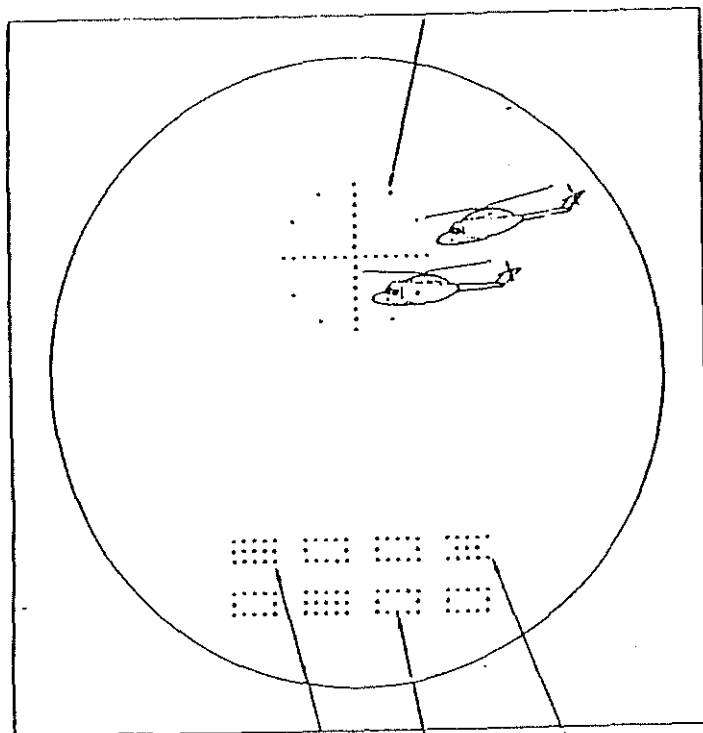

not fired fired ready to fire

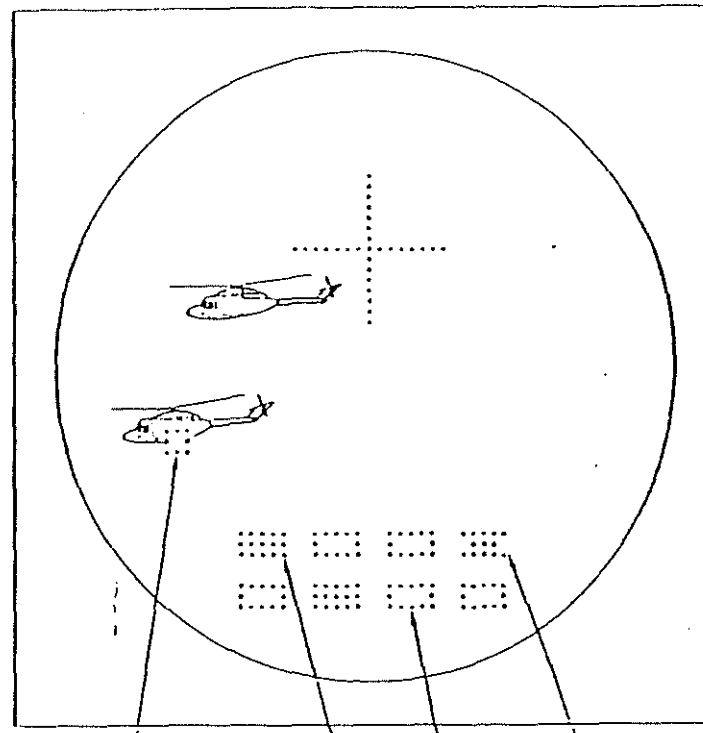

$\theta = 0.3^\circ$ not fired fired ready to fire

GAZELLE CANON FIRE CONTROL FIRING PREPARATION PROCEDURE (AIR-TO-AIR)

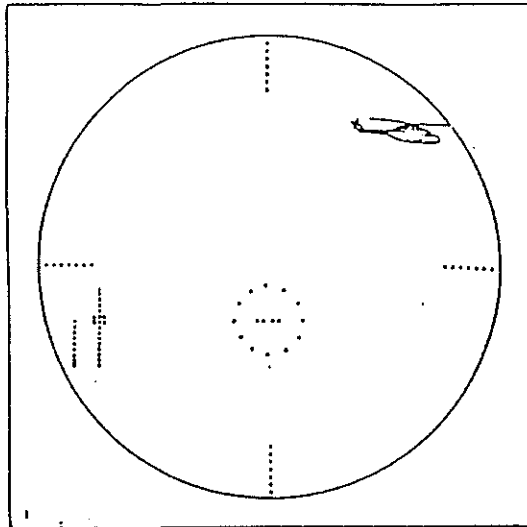

1 Helicopter maneuver to locate target within sight field.

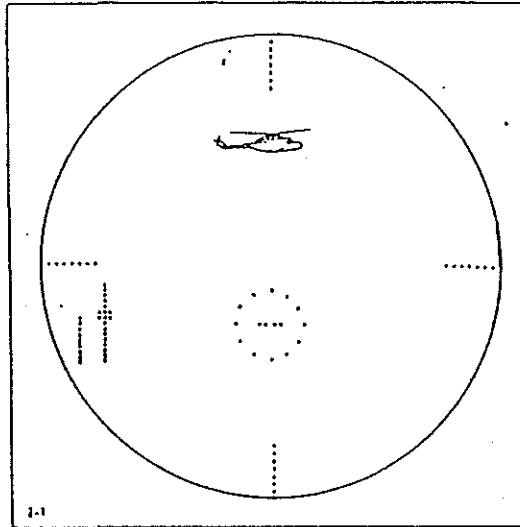

2-1 Continuation of maneuver to center target laterally.

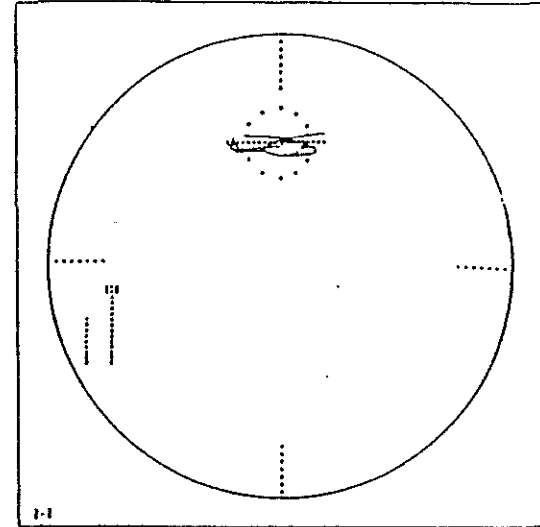

3-1 a) Adjustment of cannon elevation to position reticle on target.
b) Adjustment of horizontal stadimetry bar (10 meters).

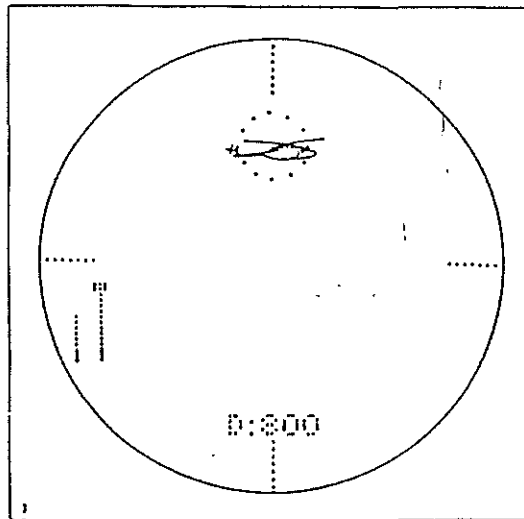

- "ACQUISITION ON" control
- Reticle held on target
- Stadimetry bar erased
- Range selection

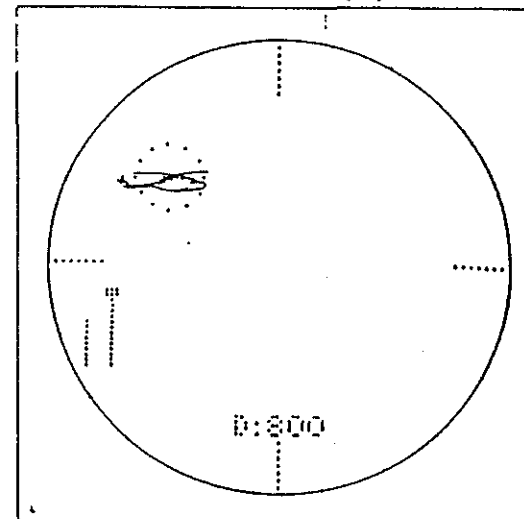

- Reticle held on target (fire prediction)
- Ready for firing (after 2 seconds)

PREDICTIVE MODE - GUN

