

SIXTH EUROPEAN ROTORCRAFT AND POWERED LIFT AIRCRAFT FORUM

Paper No. 62

ADVANCED DEBRIS MONITORING SYSTEMS
FOR HELICOPTERS

Dr. Thomas Tauber
TEDECO
(Technical Development Company)
Glenolden, Pennsylvania
U.S.A.

September 16-19, 1980
Bristol, England

THE UNIVERSITY, BRISTOL, BS8 1HR, ENGLAND

ADVANCED DEBRIS MONITORING SYSTEMS
FOR HELICOPTERS

Dr. Thomas Tauber

TEDECO
(Technical Development Company)
Glenolden, Pennsylvania
U.S.A.

Abstract

The power train of a helicopter is an integrated mechanical system. Failures in any component (engine, transmission, gear boxes) can have equally serious consequences. The helicopter condition monitoring system must therefore take an integrated approach and cover all components with equal reliability and comparable sensitivity.

This paper describes two new debris monitoring technologies which meet this condition. The first, an advanced form of electric chip detector, is already in use on the Sikorsky S-76 and Blackhawk, the Bell 222 and 214ST and the Hughes AH-64. It is in development for several European helicopters and the U.S. Army UH-1. Field data from the UH-1 evaluation are being presented.

The second technology is a light-weight, real-time magnetic particle counter which combines the advantage of debris collection, as widely used in Europe, with reliable remote failure indication. This system has the capability to monitor the rate of debris production which is the most significant parameter for the detection of failures.

In addition, the paper describes the concept of full-flow debris monitoring as the state-of-the-art for modern helicopter engines and transmissions.

ADVANCED DEBRIS MONITORING SYSTEMS FOR HELICOPTERS

1. Introduction

A helicopter drive system contains a number of oil lubricated components: engine(s), main rotor transmission, tail rotor gear box and in many cases also an intermediate gear box. The failure of any of these components can be fatal. Bearing and gear failures, which can precipitate the loss of proper drive system operation, can be detected by monitoring the lubrication system for entrained metal debris particles which are shed into the oil by the failing wear surfaces.

Except for the fact that main transmissions have forced-flow lubrication systems while the gear boxes are generally only splash lubricated, these components tend to reflect a uniform approach to debris monitoring. By contrast, the engine on the same helicopter may have a completely different debris monitoring system. These differences may include maintainability requirements, failure detection effectiveness, operating principle and location within the lube system. As new debris monitoring technologies emerge, some of them well-suited to interfacing with future aircraft's computers, integration of the debris monitoring system into the entire helicopter will become essential. It will be the task of the airframe manufacturer to specify the nature of the debris monitoring system to the engine supplier, in order to guarantee a more uniform debris monitoring system.

Until recently, only the following three debris monitoring technologies were in use on helicopters:

- . magnetic chip detectors
- . electric chip detectors
- . spectrometric oil analysis

Magnetic chip detectors (called magnetic plus in the U.S.) are simply permanent magnets installed in various places in the lube system (see Figure 1). They must be inspected frequently, either after each flight or daily or, at the very least, every 8 to 24 flight hours. This is their chief disadvantage. They are usually located in the

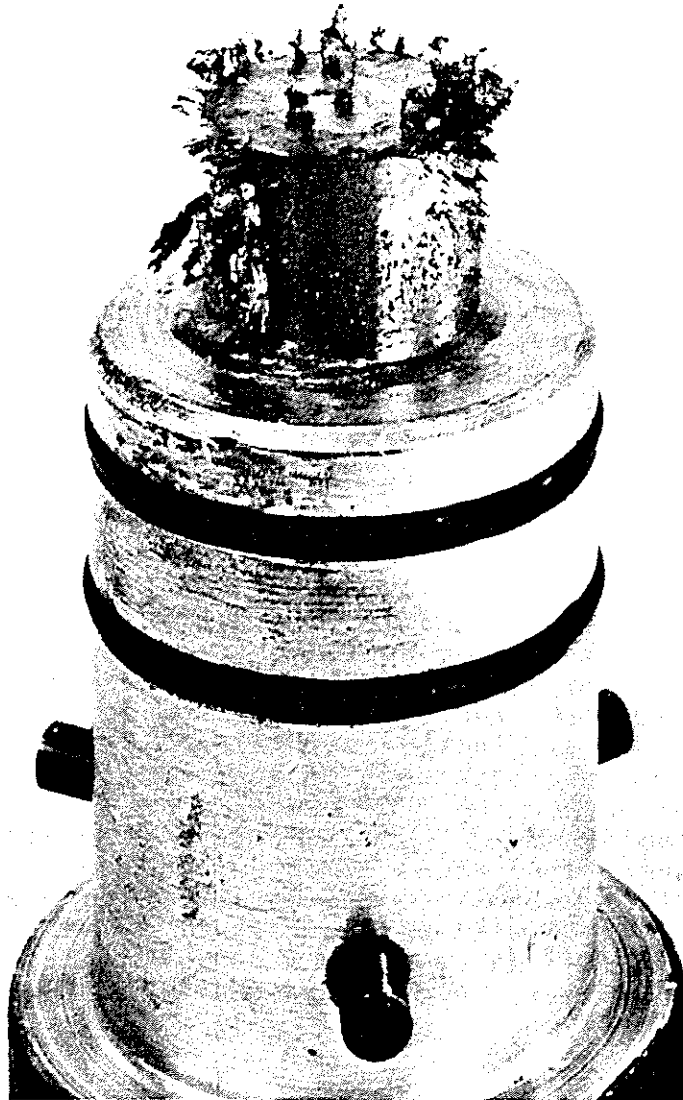

FIGURE 1: MAGNETIC CHIP DETECTOR WITH DEBRIS FROM SPINNING TRANSMISSION BEARING - ADVANCED CONDITION

sump or oil reservoir. In this case, they may capture only a fraction of the debris produced by a failing component. However, some helicopter and engine manufacturers have paid considerable attention to the proper location of the chip detectors. In this respect, Rolls Royce is perhaps the outstanding example for engines, since the chip detectors have been placed inside special adapters in the scavenge lines to insure efficient debris capture.

Electric Chip Detectors are essentially magnetic plugs with the capability to indicate the debris remotely in the cockpit. While this eliminates the need for frequent visual inspection, they are known for their high rate of false indications. These are mostly caused by insignificant, non-failure related debris ("wear fuzz").

Spectrometric Oil Analysis (SOA) is of questionable effectiveness for many of the failure modes prevalent in helicopter engines and transmissions. This can be due to high background contamination levels which are the result of relatively coarse filters. Certain failure modes, such as surface fatigue spalling, produce relatively few, large particles. Their probability to be included in a 1 cc oil sample would be small anyway, even if they would remain in suspension. Another obstacle to SOA effectiveness is the recent introduction of ultrafine filtration in helicopter engine lube systems. It has been demonstrated that these filters remove the recirculating fine debris required for SOA detection. For example, the General Electric T-700 engine shows no correlation between SOA and oil-wetted component failures due to its ultrafine oil filter.

2. Full-Flow Debris Monitoring

For debris monitoring to be effective, the debris sensor (magnetic or electric chip detector or the devices discussed below) should capture as much debris as possible. This will result in early and reliable failure detection and minimum secondary damage. As mentioned earlier, most chip detectors are located in sumps, reservoirs or in scavenge lines. Especially in large transmissions with flat sumps or in engine accessory gear boxes or scavenge lines with fast oil flows, debris capture rates can be very low (below 2% is not uncommon). As a result, failure modes with low debris production rates such as bearing skidding or spinning bearing races are widely considered to be undetectable with chip detectors.

The full-flow debris monitor represents a great improvement over this situation. As its name implies, the entire lubricant flow goes through this device. Above a certain particle threshold size, it can be 100% effective. Figure 2 shows its location in the lubrication system of a modern gas turbine engine. This lubrication system is of the "Master/Slave" type. The full-flow monitor is responsible for failure detection, while the additional magnetic chip detectors located in each scavenge line permit failure isolation. Since no provision is made within the scavenge line to make these chip detectors very effective, they capture only a small fraction of the debris sufficient for failure isolation.

The Cyclonic Debris Monitor shown in Figure 3 is a particularly effective full-flow monitor. It is a vortex chamber in which a cyclonic flow field separates the heavy debris from the lighter oil. The vortex is driven by the oil entering the chamber tangentially. The high separation efficiency of a typical unit is shown in Figure 4. At a flow of 7.5 GPM it approaches 100% for a particle size of 150 microns. Since the cyclonic flow not only separates debris but also air, such units can and have been developed which remove scavenge-entrained air at the same time with a very high degree of efficiency, in addition to separating debris.

For installation on the suction side of the scavenge pump, full-flow monitors with screens have also been very effective. Figure 5 shows a typical example for engines with external scavenge lines. The screen with the chip detector can also be located inside the pump housing.

3. Pulsed Chip Detector

For many years, European helicopter manufacturers and operators have considered magnetic chip detectors with self-closing valves as the most reliable debris monitoring devices. In the U.S., the frequent visual inspection and personnel training requirements are viewed as a considerable maintenance liability.

Several helicopter models introduced recently make use of a new chip detector technology. These so-called pulsed chip detection systems are designed to reduce the incidence of false chip indications associated with conventional electric chip detectors. Such systems are on the Sikorsky S-76 and YH-60, the Bell 222 and 214ST and the Hughes AH-64. It is available as optional equipment on the Aerospatiale AS-350 and AS-355 and on the Agusta A-109.

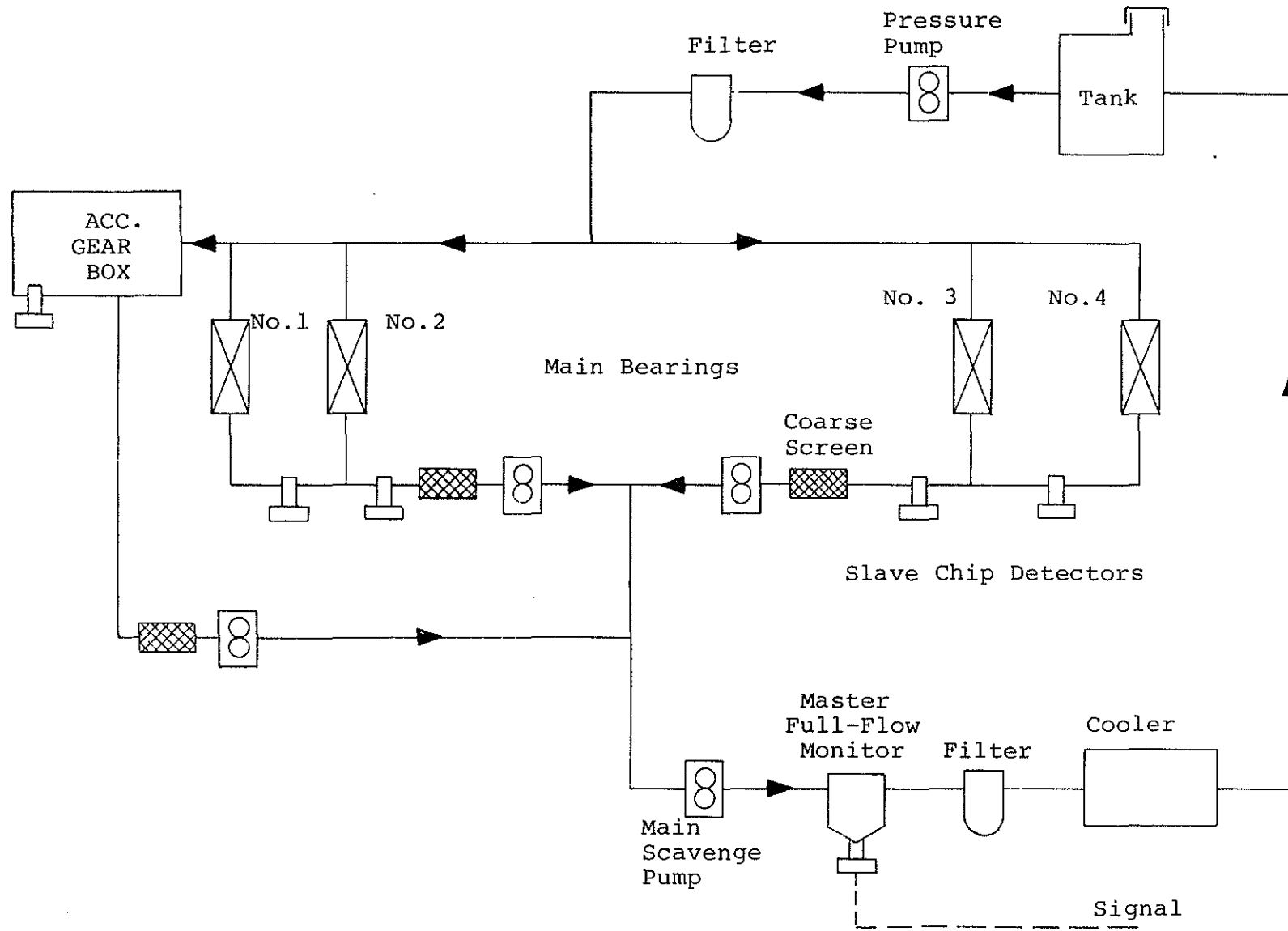

FIGURE 2: MASTER/SLAVE DEBRIS MONITORING SYSTEM FOR GAS TURBINE ENGINE

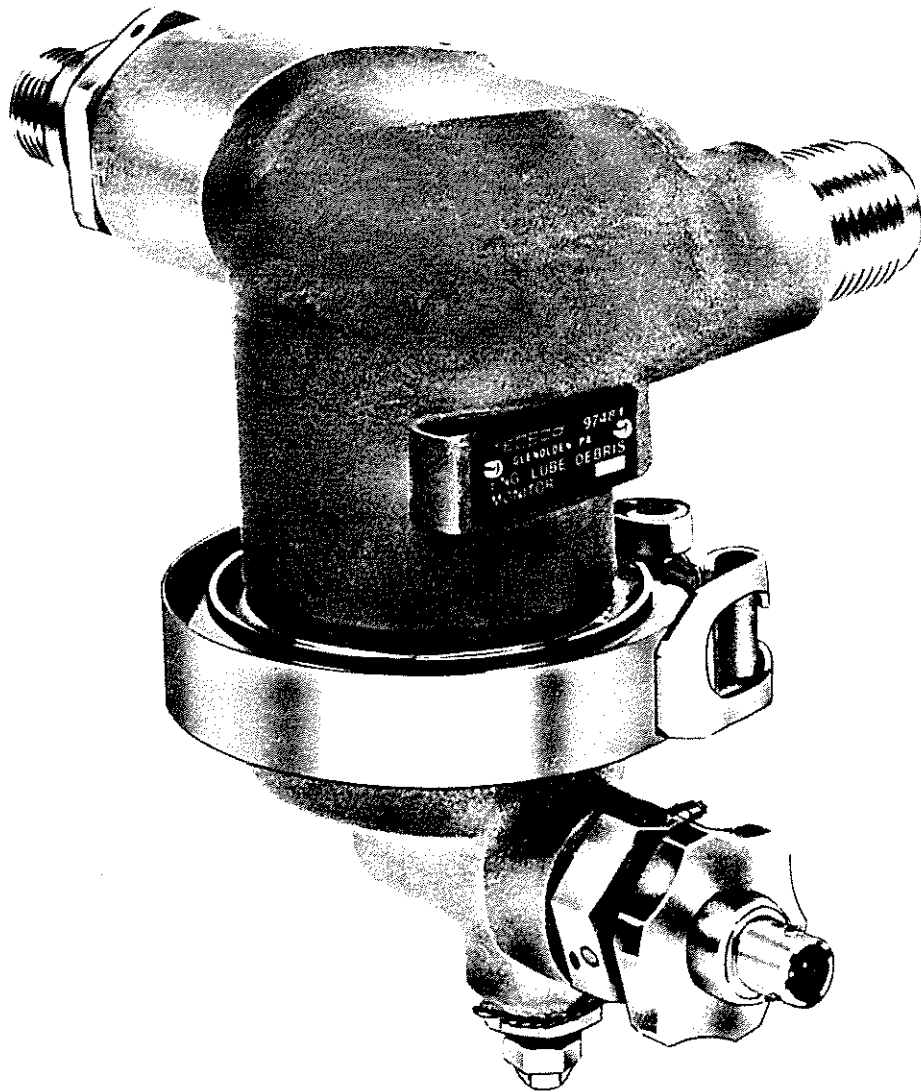

FIGURE 3: CYCLONIC FULL-FLOW DEBRIS MONITOR

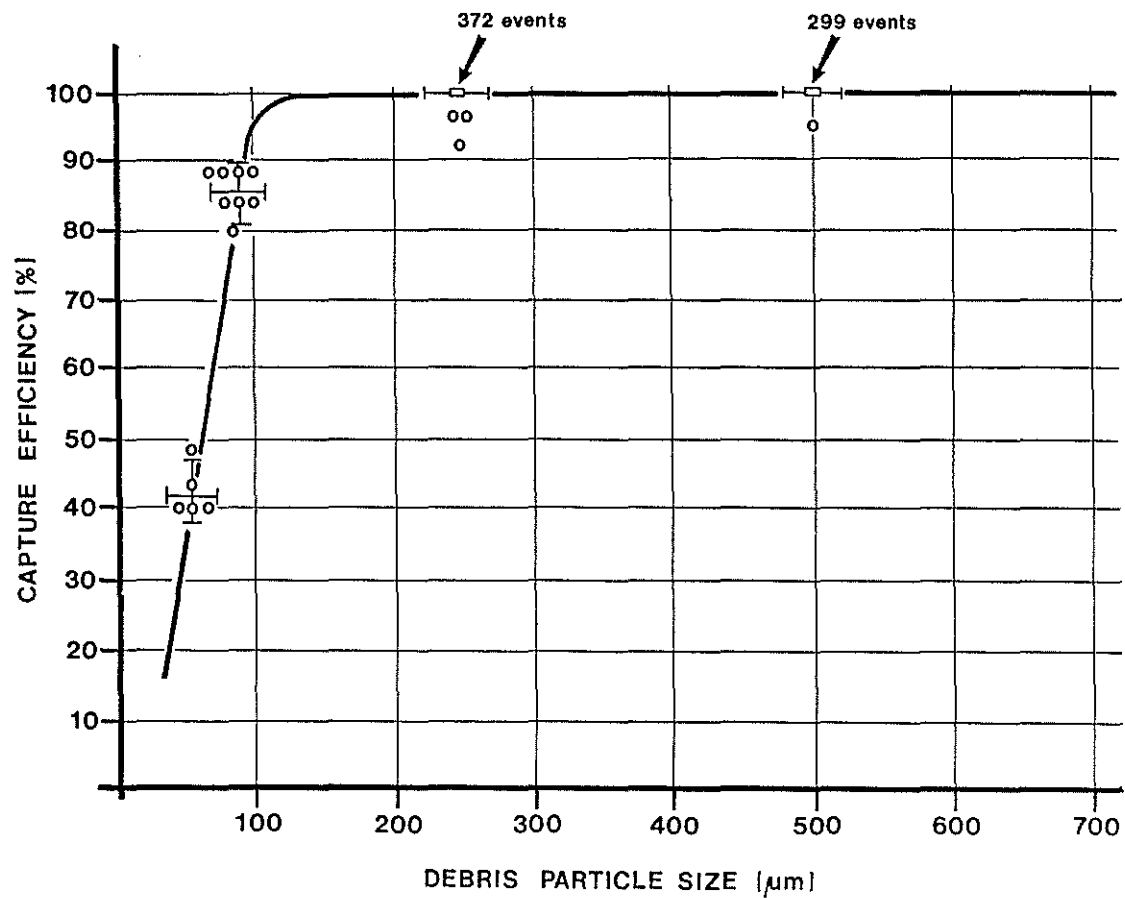

FIGURE 4: DEBRIS CAPTURE EFFICIENCY FOR CYCLONIC DEBRIS MONITOR

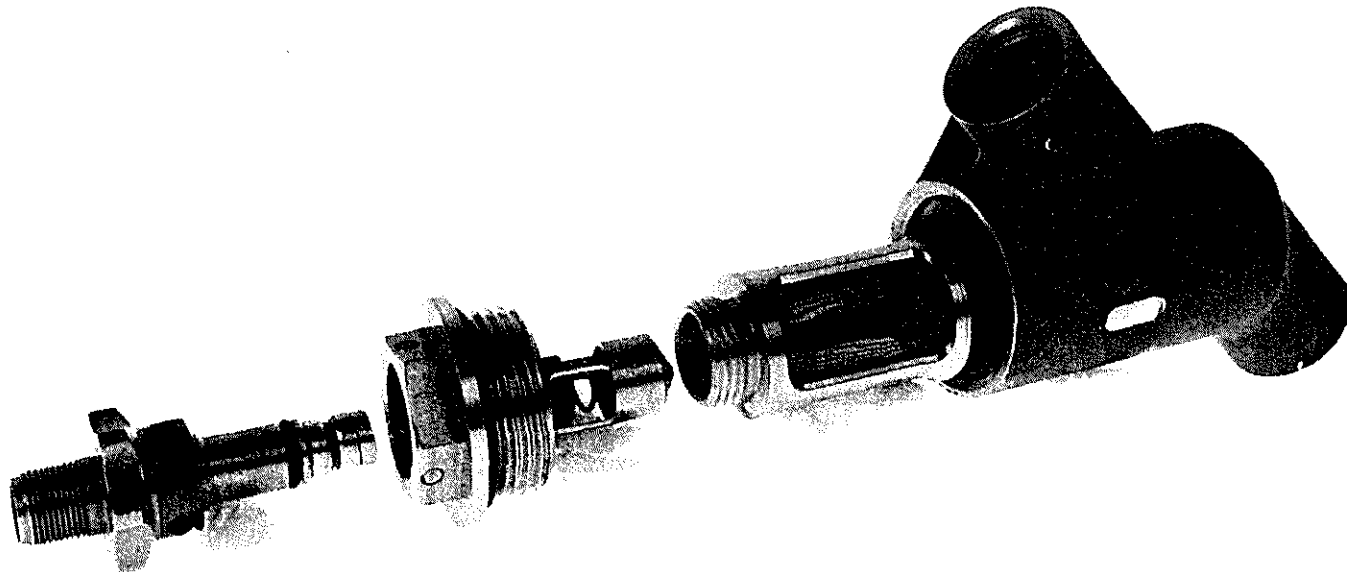

FIGURE 5: SCREEN-TYPE FULL-FLOW DEBRIS MONITOR WITH HOUSING

Pulsed electric chip detectors store a small amount of electric charge during normal operation. When debris falls on the chip gap, this creates a momentary discharge current which melts through any of the fine "fuzz" or minute slivers which usually are the cause of "nuisance" indications.

A typical cockpit indicator for a pulsed chip detection system is shown in Figure 6. This is a "manual" system in which the pilot initiates the chip pulse. There are also "automatic" systems with self-initiating chip pulse.

For the last two years, a pulsed electric chip detection system has been tested extensively on about 35 U.S. Army UH-1 helicopters. The Cyclonic Monitor shown in Figure 3 is part of this system and is installed in the scavenge line of the T-53 engine. The transmission has also been equipped with a full-flow monitor. For comparison purposes, the conventional sump-mounted chip detectors have been retained and these helicopters have remained within the established Spectrometric Oil Analysis Program.

The failures which have been detected by this system include rotating engine shaft bearing races, torque meter failures and transmission input quill and mast bearing failures. In 60,000 hours of operation, not a single failure of an oil-wetted component has been missed, while the conventional sump chip detectors have missed most of these failures (see Table 1). In this program, engines and transmissions are equipped with ultrafine filters to permit extension of oil service intervals. As a result, none of these failures have been indicated by SOAP.

The engine failure illustrated in Figure 7 was caused by a spinning No. 2 bearing race. The grooves on the race are only .0006 inches deep. There was no secondary damage and the engine was returned to service after replacement of the affected bearing and seals. The effectiveness of the Cyclonic Monitor is demonstrated by Figure 8 which shows how much of the debris generated by the bearing was collected on the pulsed chip detector.

4. Quantitative Debris Monitoring

In mature engines and transmissions, bearing and gear failures are due to surface fatigue, abrasive wear or corrosion initiated wear. These wear processes are characterized by increasing rates of debris production. Figure 9 shows the amount of debris captured on a magnetic chip detector located downstream from a failing intermediate gear box of a large commercial jet engine. The increase in the debris collection rate is the most dramatic and unambiguous indicator of this

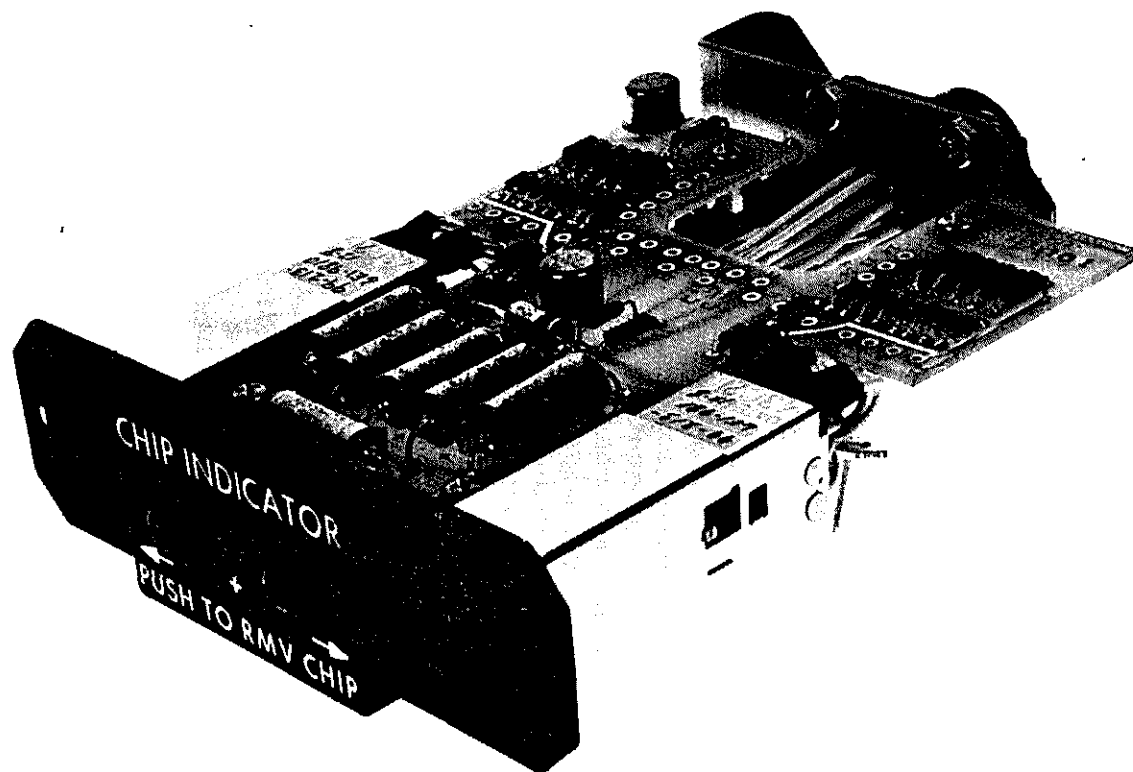

FIGURE 6: MANUAL PULSED CHIP DETECTION SYSTEM
WITH COCKPIT ANNUNCIATOR

<u>Component</u>	<u>Failure</u>	<u>Pulsed/Full Flow Chip Detector Alert</u>	<u>SOAP Alert</u>	<u>Conventional Chip Detector Alert</u>	<u>Remarks</u>
Engine	No. 2 bearing	Yes	No	No	No secondary damage.
Transmission	Input quill bearing spalled	Yes	No	No	Failure started before PCD installation. Installation led to immediate indication.
Engine	Torquemeter cylinder scored; loose No. 3 bearing	Yes	No	No	PCD installation led to immediate indication. Would have caused serious failure if left undetected.
Engine	Torquemeter cylinder scored; loose No. 2, 3 bearings	Yes	No	No	Little secondary damage.
Transmission	Mast bearing spalled	Yes	No	No	Progressing failure followed for 301 hours. 8 chip lights.
Transmission	Input drive pinion plus bevel gear failure	Yes	No	No	Failure followed for 3 chip indicators.
Transmission	Mast bearing spalled	Yes	No	No	Failure followed for 190 hours
Engine	Torquemeter cylinder scored	Yes	No	Yes	
Engine	No. 21 bearing failure	Yes	No	Yes	PCD indications preceded conventional chip detector indications. PCD indications started 130 hours prior to removal.

TABLE 1: PULSED CHIP DETECTOR EVALUATION;
UH-1 ENGINE AND TRANSMISSION FAILURES

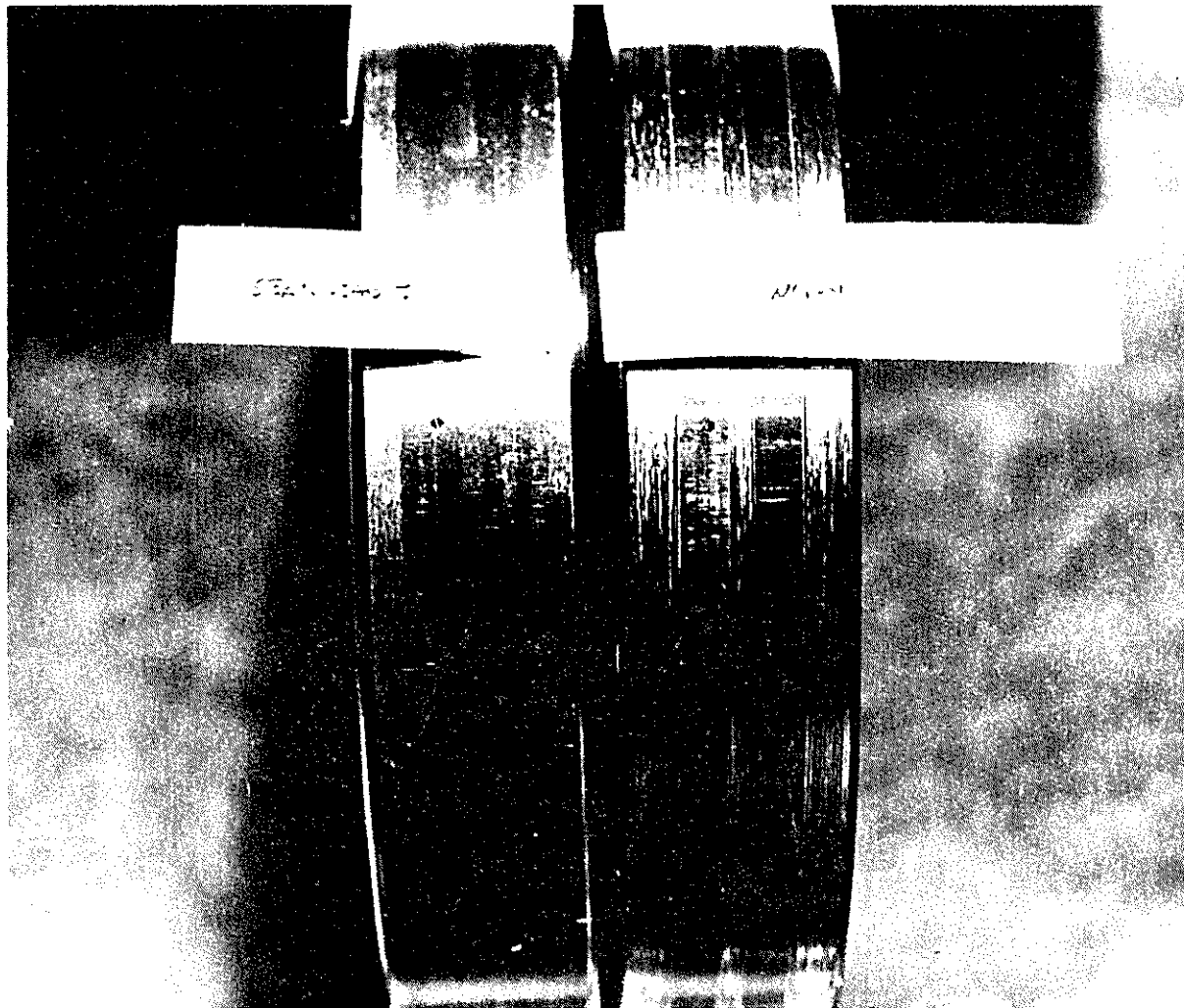

FIGURE 7: ROTATING NO. 2 BEARING RACE



FIGURE 8:
DEBRIS FROM FAILURE ILLUSTRATED IN FIGURE 7

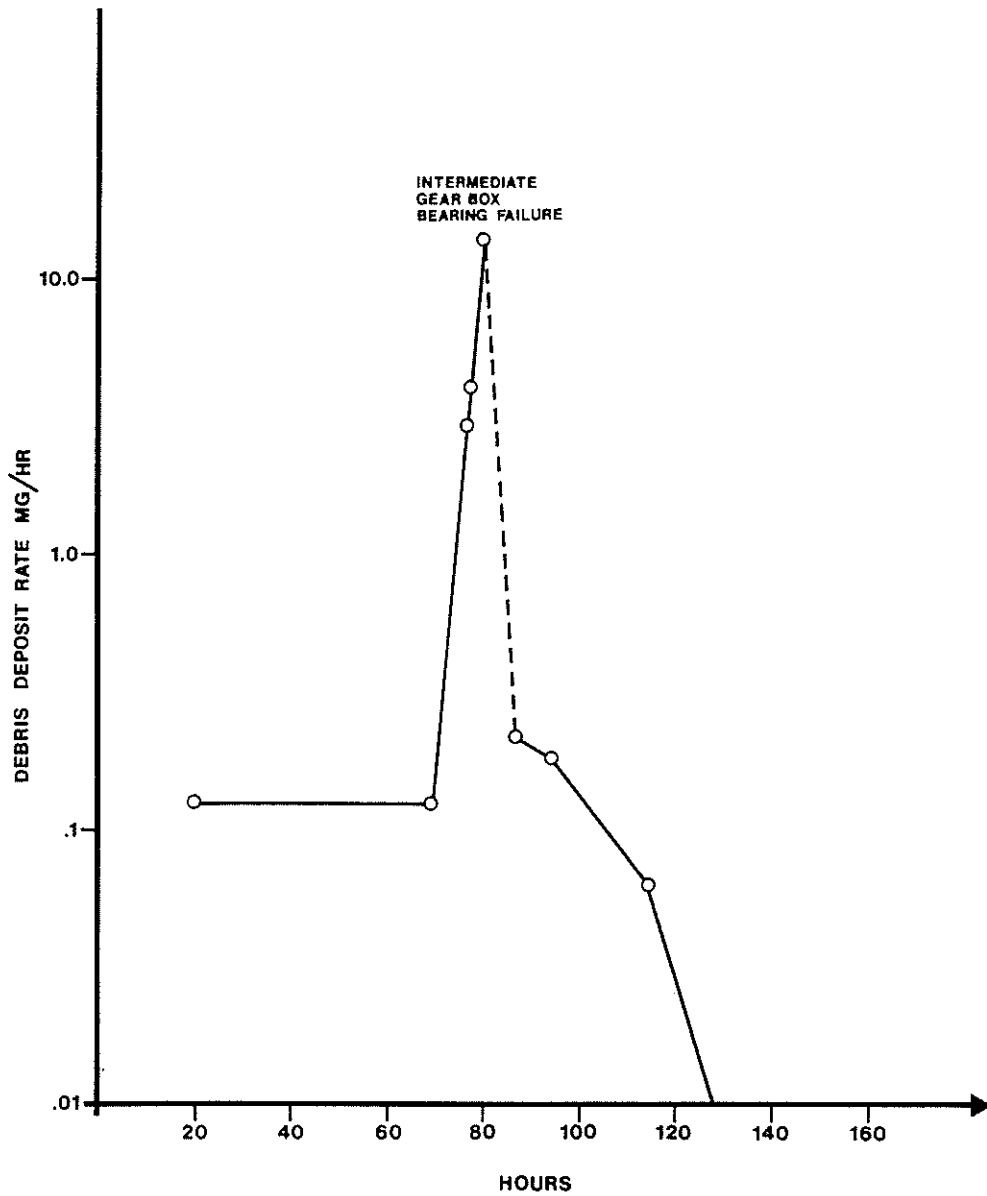

FIGURE 9: DEBRIS CAPTURE DURING JET ENGINE BEARING FAILURE

failure. Recently, on-aircraft Quantitative Debris Monitoring systems have been developed which make use of this fact. Instead of relying on oil sampling with its maintainability and logistics drawbacks, such devices provide real-time, quantitative debris production rate information which can be interpreted by an on-board computer. Figure 10 shows a system of this type. It consists of a magnetic debris sensor which is housed in a self-closing valve and a signal processor/display unit. The sensor with its strong internal magnet acts like a magnetic chip detector and collects the debris entrained in the lubricant flow. It can be located in a cyclonic separator or other full-flow monitoring device or in the sump of a splash-lubricated gear box.

Each magnetic particle above the sensitivity threshold of the sensor generates a pulse which the signal processor/display unit quantifies and counts. Although the system shown in Figure 10 is designed for ground check out, several other systems are currently being evaluated whose output interfaces directly with on-aircraft computers.

Unlike electric chip detectors, the Quantitative Debris Monitor is a true debris sensing transducer. Instead of providing one bit of information and then saturating, such a system continuously reproduces the status of the developing failure. Since fatigue and abrasive wear progresses relatively slowly, this data flow can be used to alert the maintenance crew early rather than letting a failure progress until a mission abort becomes inevitable.

This sensor also retains the debris and its self-closing valve makes it accessible for visual inspection and analysis. As a consequence, interpretative techniques and skills which maintenance crews have developed with the magnetic chip detector can be applied directly to corroborate failure indications and to isolate the failing component.

The importance of this new technology is demonstrated by the fact that a Quantitative Monitoring System is currently being considered for a major new European helicopter program.

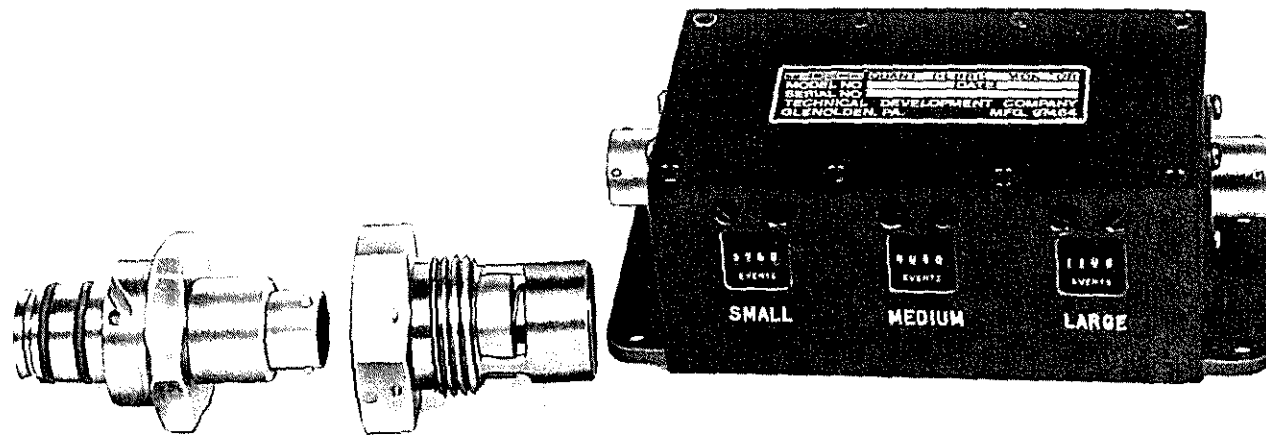

FIGURE 10: QUANTITATIVE DEBRIS MONITORING SYSTEM