

ACTIVE ROTOR CONTROL FOR HELICOPTERS: MOTIVATION AND SURVEY ON HIGHER HARMONIC CONTROL

Ch. Kessler

DLR, Institute of Flight Systems, Lilienthalplatz 7, 38108 Braunschweig, Germany

Abstract

Since the early helicopter developments, these aircraft have made a tremendous progress in performance, handling qualities, comfort and efficiency. However, modern helicopters still suffer from many problems that hinder a further increase in their efficiency, acceptance and hence their market share. The high level of vibrations and the noise generated by the rotor are the most important reasons for this. While vibrations are a concern of pilot and passenger comfort, they also give rise to an increase in maintenance efforts and costs. The high noise level limits the acceptance of helicopters in the public, e.g. landing of helicopters on or close to hospitals during EMS missions. High noise levels also lead to an early aural detection during military missions. Further drawbacks of helicopters are the high fuel consumption in high speed forward flight due to the excessive power required, the limited speed of flight, the low range for the same reason, low lead-lag damping etc. To alleviate these drawbacks of helicopters, active rotor control technologies have been investigated for a long time. Many different approaches have been investigated and most of them are not being followed any more. First investigations started with so-called Higher Harmonic Control (HHC) which has been replaced by Individual Blade Control (IBC). The paper gives a survey of the typical problems and explains the vibration and noise issues in more detail. Since active means have to compete with passive ones, such methods are also briefly addressed. Next, the paper gives a review on important HHC achievements. Due to space constraints, the paper mainly focuses on wind tunnel and flight test results. A second paper reviews IBC and gives an outlook on the idea of the swashplateless helicopter.

1. INTRODUCTION

In 2007, the helicopter community celebrated 100 years of helicopter flight. Since the early helicopter developments, helicopters experienced a tremendous improvement in performance, safety, controllability and handling qualities. Though still being a niche product, they conquered their market and can not be replaced by any other aircraft. The ability to take-off and land vertically, to hover, and the excellent low speed flight performances and handling qualities (in comparison to other VTOL aircraft) enable and consolidate this success. On the other hand, helicopters still suffer from many problems that hinder a further increase in their market share. The high level of vibrations and the noise generated by the rotor are the most important reasons. While vibrations are a concern of pilot and passenger comfort, they also give rise to an increase in maintenance effort and costs, the high noise level limits the acceptance of helicopters in the public, e.g. landing of helicopters on or close to hospitals during EMS missions. High noise levels also lead to an early aural detection during military missions. Further drawbacks of helicopters are the high fuel consumption in high speed forward flight due to the excessive power required, the limited speed of flight and hence low transport capacity, the low range (both for the same reason), etc. These problems are system immanent and are caused by the non-uniform, unsteady rotor flow in forward flight as well as by the interaction of rotor vortices with rotor blades for some flight conditions.

Nobody, however, realised that in 2002 active rotor control celebrated its 50th anniversary. In 1952 first theoretical studies started to address the principle of Higher Harmonic Control (HHC) to alleviate typical helicopter problems. In 1965 a first flight with a HHC system on a Bell 212 has been done. HHC is based on actuators located below the swashplate, thus limiting mechanically the applicable control frequencies in the rotating frame for rotors with more than three blades. Although HHC demonstrated its capabilities to reduce vibrations and noise caused by blade-vortex-interaction (BVI), other active control means were investigated more and more in the 1980s. The main drawback of HHC is the limitation to certain control frequencies (see below), and due to the fact that noise and vibrations could often not be reduced at the same time. The most promising alternative to HHC is Individual Blade Control (IBC). IBC is based on actuators in the rotating frame and hence gives the engineer the opportunity to overcome the limits inherent to HHC. Many IBC concepts have been designed and tested, both in wind tunnel as well as in flight. Early concepts focussed on blade root actuation that replaced the control rods which connect the swashplate with the pitch horns by hydraulic actuators. Advanced designs address the principle of on-blade actuators that drive a trailing edge flap. Even more advanced applications try to integrate distributed actuators into the blade (spar or skin) to generate active twist distributed along the rotor blade radius. Further concepts are nose droop or leading edge flaps, Gurney flaps

or soft trailing edges, multi-washplate systems and so on. Despite more than 50 years on R&D on rotor active control technology, no serial production helicopter makes use of such a powerful system. This fact is a tribute to the challenging requirements on minimum system complexity, high reliability, failsafe behaviour, certification issues and of course effectiveness with respect to the mentioned problems, minimum weight, costs, and last but not least the high loads acting on the rotor and the blades.

2. VIBRATION AND NOISE ASPECTS AND THEIR PASSIVE REDUCTION

A detailed overview on passive vibration reduction is given in [1] and a more general discussion on vibration in [2]. Figure 1 shows the reduction of helicopter vibration levels since 1955. Since then, a dramatic reduction in vibration levels has been achieved by better design, e.g., tuning of rotor dynamics, as well as the introduction of passive vibration reduction means like rotor integrated bifilars and pendulum absorbers, isolation systems between transmission and fuselage like Bell's Nodal Isolation Beam System and Eurocopter's Anti Resonance Isolation System (ARIS) [3], Système Antivibratoire à Résonateur Intégré à Barres (SARIB) [4], or fuselage mounted absorbers. These means are rather cheap, but increase helicopter empty weight. Since noise requirements, see below, result in larger rotor speed variations, purely passive means become less efficient. Meanwhile, Moog and other companies have also developed actively controlled absorbers which are used in series production helicopters. Some vibration reduction means are shown in Figure 2. For modern helicopters the vibration trend does not fall below 0.05g to 0.1g and a further significant reduction through passive means does not seem to be feasible. The value of 0.02g recommended by NASA does not seem to be within reach.

An advantageous property of vibrations in the fuselage is their frequency content. If the rotor of a helicopter is well balanced, the dominating frequencies of a rotor with N_{Bl} blades at a rotor rotational frequency Ω are:

$$(1) \quad \omega_m = m N_{Bl} \Omega, \quad m = 1, 2, 3, \dots$$

and are generated from $N_{Bl}\Omega$ and $(mN_{Bl} \pm 1)\Omega$ harmonics in the rotating frame. In this respect, the rotor acts as a filter. The amplitudes usually become smaller with increasing frequency and rotors with more blades have less frequency content, see Figure 3. This figure shows frequency spectra for a 2-bladed Bell Jet Ranger and a 4-bladed BO105 for two different speeds. It can be clearly seen that the vibrations vary significantly with the flight condition and simple considerations as the one above have to be carefully checked in detail. Nevertheless, as a first guess it can be stated: one consequence to reduce vibrations would simply be to use rotors with more blades. However, this is often not favourable due to more complex rotor heads, higher costs, weight, etc.

The impact of vibrations on passengers does not only depend on the acceleration magnitude, but also on the excitation frequency. This effect is known since an early work on shock and vibration in 1960 [5]. Figure 4 defines three

thresholds (perception level, unpleasant and intolerable) as a function of magnitude and frequency of vibration. It clearly shows: most important to humans are vibrations with frequencies below 20Hz. But it also shows that vibrations become unpleasant for vibration levels at about 0.1g or even below. And this is still the range of vibration levels achieved on modern helicopters.

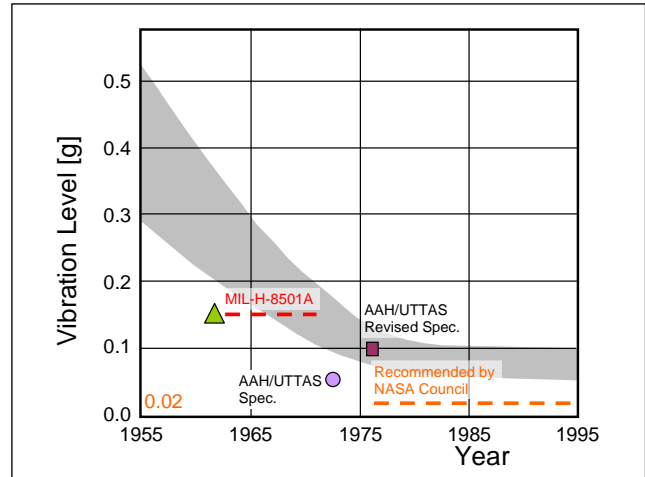

Figure 1: Trend for helicopter vibration levels.

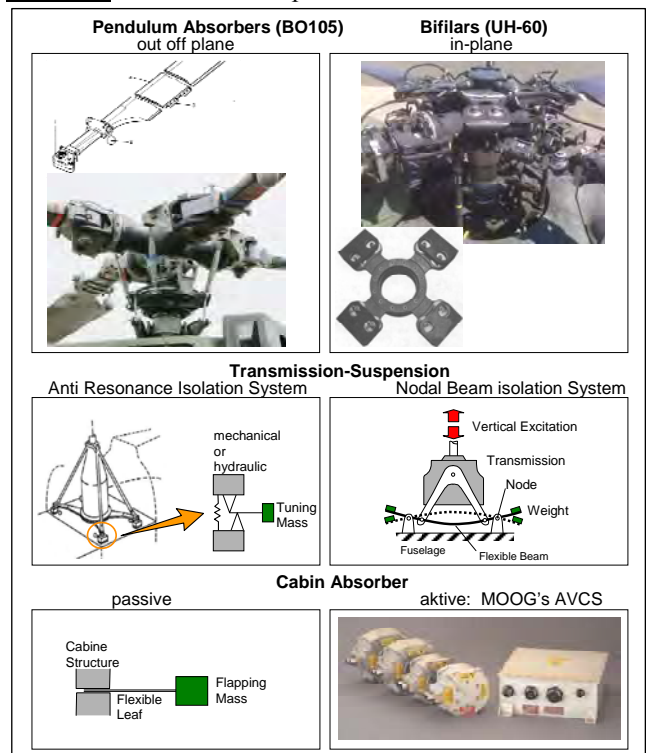

Figure 2: Vibration absorption means

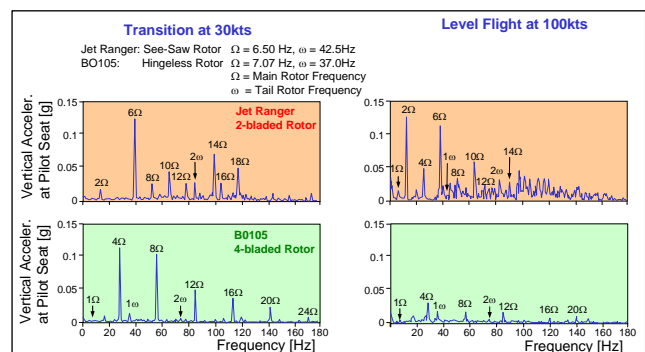

Figure 3: Vibration spectra of different helicopters

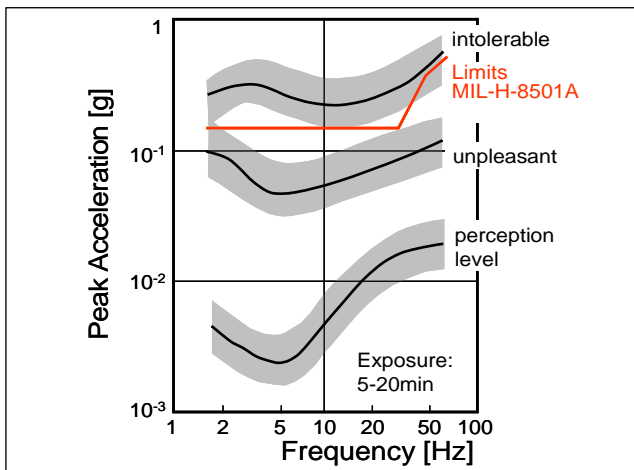

Figure 4: Effect of vibration perception on humans.

Meanwhile authorities also address the vibration issue. Ref. [6] defines minimum requirements for health and safety of employees exposed to vibrations. Yet, it leaves exceptions for air transport, but this situation might change in the future. For operators, vibrations cause high maintenance costs. A combined US-Army and Sikorsky study [7] shows this relation clearly. Based on a comparison of two H-3 helicopter fleets (one with bifilars, the other one without), the fleet with bifilars showed 10% lower live cycle costs although it has been operated in a harsher environment than the other.

In contrast to vibrations, which are of concern for pilot and passenger comfort as well as for operators, noise radiated by the helicopter is more relevant to the public and hence is a strong certification issue. A summary on helicopter related noise issues and its relevance to a community is given in [8]. In 2001, the allowable noise limits have been tightened by several dB depending on the flight condition and take-off or landing weight [11]. This is shown in Figure 5. A noise certification data base in Europe is being compiled by EASA. Information is available on an internet web site¹.

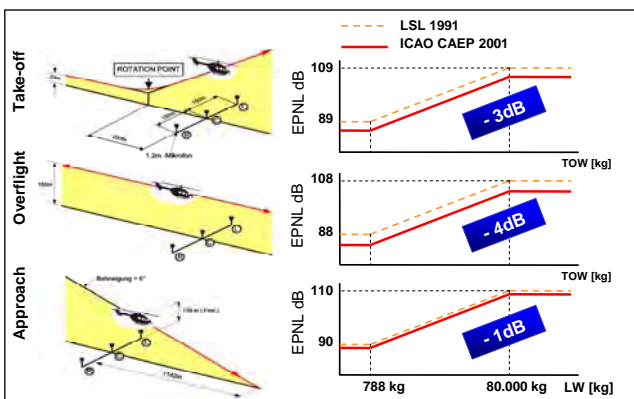

Figure 5: Noise certification values

TOW = Take-Off Weight, LW = Landing Weight

Again, a further reduction of noise certification levels might be expected, since modern helicopters already generate significantly less noise radiation than current certification requires. The following noise sources contribute to the overall noise of helicopters: main rotor (thickness and load-

ing noise, blade vortex interaction (BVI), high speed impulsive noise, blade wake interaction, trailing edge noise), tail rotor (same as for main rotor and in addition interaction with body and main rotor wakes), engines, (compressor, turbine, combustion) and airframe (fuselage, skids). While BVI is of more concern during decent, thickness and loading noise are of general importance during all flight segments. To alleviate rotor generated noise, new blade designs can help significantly as well as the reduction of rotor rotational speed. How well proper blade design can reduce noise has been demonstrated in a joint Onera-DLR research programme called ERATO (Etude d'un Rotor Aéroacoustique Technologiquement Optimisé) [9].

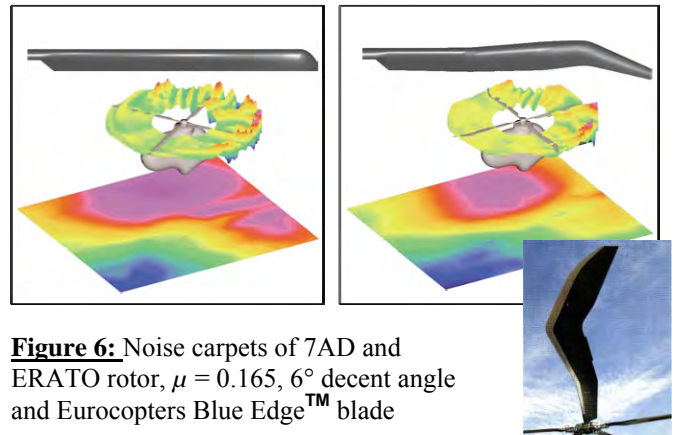

Figure 6: Noise carpets of 7AD and ERATO rotor, $\mu = 0.165$, 6° decent angle and Eurocopter's Blue EdgeTM blade

Figure 6 shows the noise carpets of the 7AD reference rotor and the ERATO rotor as measured in the wind tunnel. Red spots symbolize high noise levels. As can be seen, the novel ERATO design has decreased the rotor generated noise significantly by 4-5dB at the certification condition for landing approach, 7dB and more at high lift conditions. In addition, approx. 10% less power required turned out at high speeds. This called Eurocopter's attention to the ERATO design. Eurocopter has shown a slight modification as its Blue EdgeTM design at the Heli-Expo 2010 in Houston.

This demonstrated that proper optimisation of blades can reduce rotor noise signature significantly. A further reduction of noise radiation may be achieved when combining the low noise design with active rotor control. On the other hand, it might not be easy in the future to fulfil all the requirements of modern rotor blade design like requirements on noise, low profile drag at high lift, less dynamic stall, low control loads, aeroelastic stability, vibrations or even generation of dust clouds in arid areas etc. at the same time.

In contrast to the ERATO blade (which has been designed for minimum noise levels) the British Experimental Rotor Blade (BERP) has been optimised to meet the conflicting aerodynamic requirement on advancing and retreating side of the rotor disc. Both operating conditions of the blade can limit high speed flight performance [10].

3. HHC VERSUS IBC ARCHITECTURE

In the past, active Rotor Control has demonstrated its capability to overcome the problems mentioned above and, depending on the concept, simultaneously. Before a survey

¹ http://www.easa.europa.eu/ws_prod/c/c_tc_noise.php

on the results gathered is given, the difference between HHC and IBC and its advantages/disadvantages shall be presented. In principle, it shall be distinguished between HHC (which incorporates actuators below the swashplate in the non-rotating frame) and IBC (which requires actuators in the rotating frame above the swashplate), see Figure 7. For IBC it is also relevant, where the actuators are being placed. First concepts replaced the push or pull rods between swashplate and pitch horn by hydraulic actuators. Later designs integrate the actuators into the blades. The various IBC concepts will be outlined in [42].

Based on their fundamental design, HHC and IBC show advantages and disadvantages. Inherent to HHC is a simple design. It does not require any means to transfer hydraulic or electrical energy or signals from the fixed frame to the rotating frame or back. Additionally, the actuators are not exposed to centrifugal loads, caused by the rotating rotor. In contrast, blade mounted IBC actuators undergo blade flap, lag and torsion motion and the stress generated by these. With respect to rotor hub and blade design, both can be designed applying conventional methods and know-how. Just the assessment of the design loads has to be checked carefully.

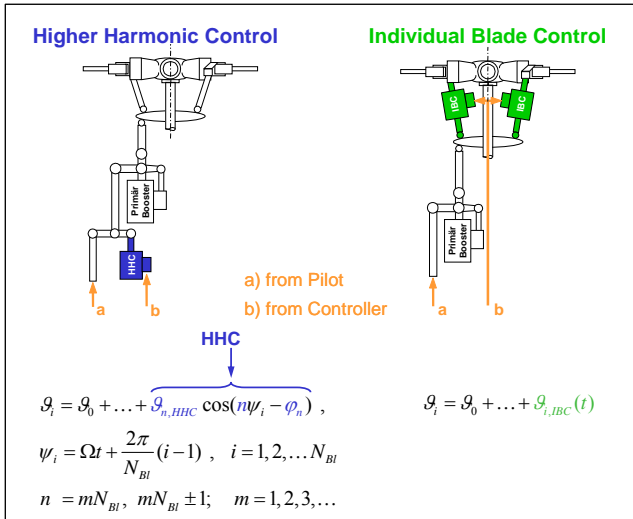

Figure 7: Comparison between HHC and IBC.

However, a severe disadvantage of HHC is the limitation to certain fixed control frequencies that depend on the number of blades N_{Bl} . In principle, the HHC control frequencies are limited to harmonic signals in blade pitch:

$$(2) \quad \begin{aligned} \mathcal{G}_i &= \mathcal{G}_0 + \mathcal{G}_s \sin \psi_i + \mathcal{G}_c \cos \psi_i + \mathcal{G}_{HHC} \\ \mathcal{G}_{HHC} &= \mathcal{G}_{n,HHC} \cos(n\psi_i - \varphi_n) \\ \psi_i &= \Omega t + \frac{2\pi}{N_{Bl}}(i-1), \quad i = 1, 2, \dots, N_{Bl} \\ n &= mN_{Bl}, \quad mN_{Bl} \pm 1; \quad m = 1, 2, 3, \dots \end{aligned}$$

where \mathcal{G}_i is the total blade pitch of the i -th blade, \mathcal{G}_0 , \mathcal{G}_s , and \mathcal{G}_c collective and cyclic inputs controlled by the pilot. The HHC input is \mathcal{G}_{HHC} which has three control variables: HHC amplitude $\mathcal{G}_{n,HHC}$, frequency $n\Omega$ and HHC phase φ_n . Unfortunately, the frequency factor n is limited to integer multiples m of blade number mN_{Bl} and $mN_{Bl} \pm 1$. These frequencies are usually identified as “per rev” (.../rev). This

implies for a helicopter with 4 blades a limitation to the following frequencies: 3, 4, 5/rev and integer multiples of the blade passage frequencies plus the next harmonics before and after it (e.g. 7, 8, 9/rev ...). The very useful 2/rev frequency can not be controlled by HHC for the 4-bladed rotor. This frequency turned out to be very valuable to reduce noise or required rotor power, see results in [42]. Since IBC can overcome this limitation arbitrary blade pitch motions can be superimposed to the pilot’s controls. However, in most studies harmonic functions even for IBC turned out to be very effective and real arbitrary time dependent IBC inputs were not required so far. This can be explained by the nature of the problems addressed with IBC and becomes evident, e.g., for the vibration reduction task, see Figure 4. This severe HHC drawback is limited to helicopters with more than three blades. For helicopters with two and three blades, the three DOF of the swashplate (\mathcal{G}_0 , \mathcal{G}_s , and \mathcal{G}_c) are opposed to three blade pitch angles in maximum, and arbitrary blade signals, even IBC, can be realised, see eq. (2). This, however, is of a more theoretical aspect, since three or fewer blades are used for such helicopters only, which show a low take-off weight and in most cases low purchase price. For such helicopters, even HHC would be too expensive, aside a reduction in useful load due to the HHC hardware. Nevertheless, the relation of the three DOF of a swashplate and the IBC capability for up to three blades should be kept in mind. It will become important for so-called multi-swashplate arrangements, see [42]. Another drawback of HHC becomes evident by eq. (2) for large blade numbers. The more blades a helicopter has, the less frequencies can be controlled by HHC. For the 7-bladed CH-53E rotor for example 2/rev to 5/rev, 9/rev to 12/rev etc. can not be controlled. This is no problem for IBC. But, IBC requires one actuator for each blade, HHC just three in the fixed frame.

4. HOW IT ALL STARTED: HHC

First investigations on active rotor control technology based on HHC go back to 1952 [12]. Before that, 2/rev inputs were used for fatigue testing of rotors on whirl towers. First investigations as [12] to [14] were of a theoretical nature. Based on the available computer hardware, very simple simulation models applying simple blade aerodynamics and dynamic models were used. STEWARD [12] focused on the reduction of blade stall on the retreating side of the rotor disc by 2/rev control and a redistribution of the lift (reduce lift on the retreating side and advancing side and increase it on the fore and aft sectors of the rotor disc) for increasing flight velocity by HHC. Using simple models, he derives a relation between flapping, Lock-number γ and the resulting blade incidence α due to second harmonic control. His conclusions were:

- heavy blades ($\gamma \rightarrow 0$) have practically no flapping and the total control input appears as incidence α ,
- medium blades ($\gamma \approx 12$) show an incidence to pitch amplitude of approximately $1 / \sqrt{2}$,
- very light blades ($\gamma \rightarrow \infty$) have strong flapping which cancels out the control input and hence does not result in any change of incidence.

Based on his studies applying 6° amplitude for the 2/rev

control, he further estimates an increase in advance ratio μ of approximately 0.1. However, the models he used (constant inflow, rigid blade flapping, no torsion, no lead-lag, no stall, ...) lacked accuracy required to give reliable results. Nevertheless, his great merit has been to start a discussion and create a research field that still is of concern today.

PAYNE [13] picked up the idea of delaying blade stall through HHC. Compared to the relatively simple assumptions in [12] he applied refined models to achieve the ideal lift distribution throughout rotor revolution by HHC and his work focuses mostly on the derivation of such more sophisticated equations. His model assumptions include hinge constraints (elastic or offset hinges), longitudinal downwash gradients (GLAUERT model), n HHC harmonics, blade twist and taper. Pitch-flap coupling is omitted, but is important for some helicopters like the BO105. Achievement of such ideal lift redistribution would require more than first and second harmonic control inputs. He concluded that dynamic characteristics of the blade would require careful adjustment to avoid torsional resonance. Later, the torsion response due to active control inputs of whatever kind was seen beneficial in order to assist in achieving the required air load, see [42] for more details. Like STEWARD, PAYNE concluded that the greatest angle of attack changes can be achieved for heavy blades or for very stiff ones. This is inherent to his expression for the change in angle of attack $\Delta\alpha$ in hover. The n -th harmonic in $\Delta\alpha$ caused by the n -th HHC-input is given by the relation (X = stiffness inertia parameter):

$$(3) \quad \Delta\alpha_n = \frac{[B_{ns} - XA_{ns}] \cos n\psi - [A_{ns} + XB_{ns}] \sin n\psi}{[X + 1/X]},$$

$$X = \frac{c_k - (n^2 - 1)\gamma}{nt_4}$$

where c_k is the hinge stiffness coefficient and t_4 a taper integral, see [13] for more details, and A_{ns} and B_{ns} are the sine and cosine coefficients of the n -th HHC-input. The phase lag of angle of attack change to n -th HHC-input is:

$$(4) \quad \psi_{\alpha_n} - \psi_{g_n} = \frac{1}{n} \tan^{-1}(1/X).$$

ARCIDIACONO [14] continued to investigate stall delay through HHC. The models he used were capable to consider stall, different airfoil section, Mach-number effects, large inflow and flapping angles, blade planform and flapping hinge offset. Due to missing data, he neglected unsteady aerodynamics, assumed constant inflow and rigid blades. He separated the lift distribution in the rotor disk into two areas, whereas the lift in area 1 is at or close to the maximum section lift (c_{lmax}) and is reduced in area 2 (c_l). Both areas are specified by radial and azimuthal coordinates. This introduces two discontinuities in angle of attack distribution (one in radial and one in azimuthal position) see [14] for more details. To balance rolling moment, two considerations need to be addressed for placing area 2: 1) since the rolling moment of the rotor must be zero or very nearly so, it follows that the lift must be reduced on the advancing side, 2) area 2 needs to be placed such that its blade elements have maximum moment arm about the roll-

ing axis. Therefore, aerea 2 was placed in general on the advancing side at large radial stations. However, for his computations the inner radial start of aerea 2 was set to zero and its radial end to rotor radius. An example calculation of one blade's C_T is shown in Figure 8. The black solid line represents a rotor without HHC, the green dashed line is the ideal thrust distribution computed from the two area model and the blue solid line tries to approximate this ideal thrust distribution through $2/rev$ and $3/rev$ HHC. Start and end of area 2 has been chosen to be 45° and 135° respectively. Please note: the original HHC notations of ARCIDIACONO have been converted to the notations given in Figure 7. The conventional thrust distribution shows negative thrust at the advancing side and at 0° and 180° moderate thrust when compared to the thrust that could be ideally achieved at these positions. This limits forward speed. The ideal thrust distribution derived from his simple models shows an increased average thrust and slightly negative thrust in area 2 for roll moment trim. The HHC case approximates the ideal distribution. This increases overall rotor thrust and hence speed.

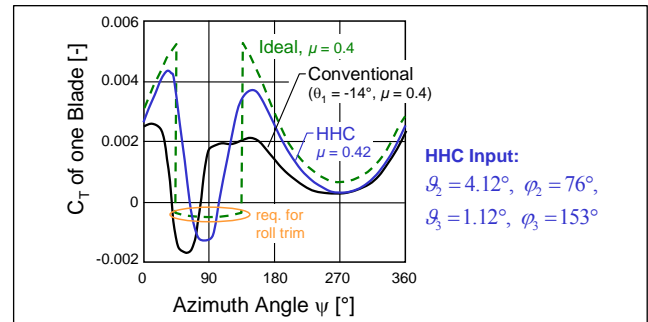

Figure 8: Real, ideal and approximated thrust distribution of one blade, $\mu = 0.4, 0.42$, $M_{Hover} = 0.587$, $\sigma = 0.082$.

Since ARCIDIACONO used a helicopter with a 5-bladed rotor to further compute e.g. power required, but applies 2 and $3/rev$ control, he indeed did not apply HHC, but IBC for the reasons explained in section 3. He concluded that $2/rev$ feathering could increase the speed by approx 25% and adding $3/rev$ by further 5%. But these figures need to be taken with some care. His models were rather simple. It is not clear, why C_T of the ideal thrust distribution at $\psi = 270^\circ$ shows larger values than C_T of the conventional rotor. Finally, ARCIDIACONO proposed a mechanical HHC system as shown in Figure 9.

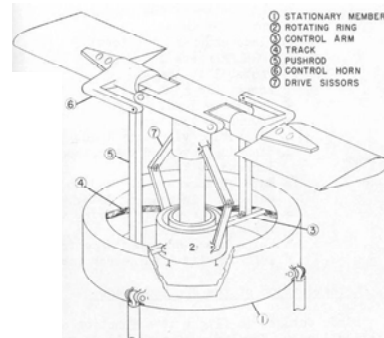

Figure 9: Proposal of mechanical HHC system.

His design featured a curved track cut into the stationary part of the swashplate. Rotating control arms ride in this track and move the push rods vertically. Surly, this design

would suffer from fatigue and wear. However, largest drawbacks would be the pre-shaping of the curved track and its impossibility to adapt HHC amplitude and phase to the flight state as well as the fact, that the generated HHC input can not be switched off, e.g. in hover.

While first investigations focussed on the enhancement of helicopter maximum speed, first flight tests focussed on the effect of $2/rev$ HHC on vibrations, oscillatory rotor loads and stall [15]. First flight tests were conducted by Bell on an UH-1A with a 2-bladed, semi-rigid rotor. Bell started to test a simple passive system of generating a $2/rev$ HHC in 1960. However, it was suspected that the resulting $2/rev$ pitch change would not be at the right phase for maximum benefits. Therefore, the stabilizer bar of the test vehicle was removed so that the output from the HHC mechanism could be introduced through stabiliser bar mixing levers. A photo of the assembly is shown in [Figure 10](#).



Figure 10: HHC assembly on UH-1A tests vehicle.

Since just $2/rev$ HHC has been studied, the $2/rev$ input for a 2-bladed rotor requires $2/rev$ collective input. The amplitudes and phase angles with respect to the blade azimuth were adjustable in flight. This was achieved by the degree of tilt and the tilting direction of the HHC assembly. For not increasing the blade bending moments too much by HHC, a maximum amplitude of 1.1° blade feathering has been allowed and was even reduced to 0.3° for some cases. Using 0.3° of $2/rev$ HHC [Figure 11](#) shows the effect on vertical vibrations at the pilot's seat and the c.g., as well as the effect on the pitch link and the lift link loads versus speed. The lift link at the UH-1A is a connecting member between the bottom of the transmission and the fuselage. The black line is the reference case without HHC, the red dashed line the results from choosing the wrong phase (i.e. maximum increase) and the blue dashed line the optimum case with maximum reduction. The optimum phase angles shown above each sub-figure correspond to the maximum reduction of the signal shown in the sub-figure below it. Although the flight test has not been fully successful to meet all objectives, the project did demonstrate that some reduction in vertical vibration can be achieved by proper application of HHC. Two conclusions can be drawn from this result. First, the optimum phase angle depends on which target needs to be minimised and, secondly, on the airspeed. Please note that the phase angle definition used in [15] and [Figure 11](#) has 180° phase shift to the notations used in [Figure 7](#). The beneficial effects of HHC on vibra-

tions and load reduction were relatively small. It was concluded from high gross weight flights that $2/rev$ HHC would not be effective in the delay of retreating blade stall. The stall investigations at high speeds were performed with restricted amplitudes because of high control loads, violent vibrations and significant fore and aft motions of the pylon. However, a data analysis indicated that the results apply specifically to the UH-1A fuselage and rotor system. It was concluded that the response of other helicopters to $2/rev$ HHC might be significantly different. This turned out to be right. WERNICKE and DREES also concluded from the aerodynamic response to $2/rev$ HHC that HHC applied to only a portion of the blade might be superior to blade root HHC, since it varied along the blade span.

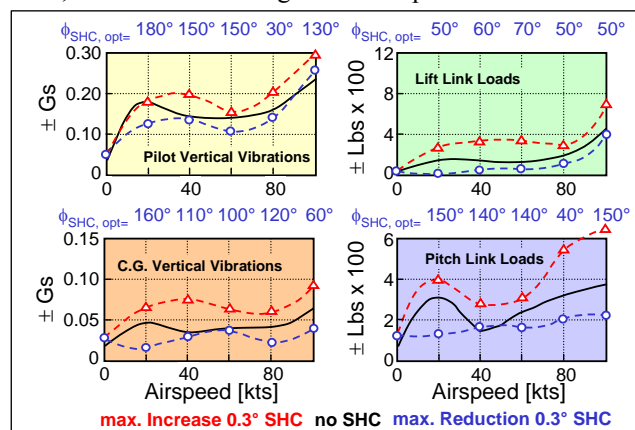

Figure 11: Effect of applying $2/rev$ control.

SISSINGH and DONHAM [16] used a 7.5ft 4-bladed hingeless, stiff-inplane rotor wind tunnel model to study vibration reduction by HHC using $3, 4$ and $5/rev$ control. Since no instrumentation for vibratory rolling and pitching moments was available, the flap bending moments at $0.073R$ were measured and added up to obtain these moments. However, this neglects the in-plane forces, vertical shear forces and blade torsion which have an influence on hingeless rotor designs. Five different flight test conditions with advance ratios of μ in the range from 0.191 to 0.851 have been studied. While at low μ the rotor has a high loading of $C_T/\sigma = 0.102$, the rotor is practically unloaded $C_T/\sigma = -0.013$ at high μ . This can be achieved by lift and thrust compounding². As expected, the control amplitudes to reduce vibrations increased with increasing advance ratio and varied from 1.0° to about 3.0° . The latter was required for the case showing highest vibration levels at $\mu = 0.849$. There, a reduction in pitching and rolling vibratory moments of 15% and 18% of the reference values w/o HHC was achieved.

A second flight test campaign was commonly performed by Hughes Helicopters, NASA and US Army on a 4-bladed OH-6A with an articulated rotor. A detailed description of the hardware can be found in [17]. The objective was to reduce the $4/rev$ vibration content in the fuselage by using a 3 to $5/rev$ HHC blade feathering. Several design studies of the mechanical components of a HHC system were outlined. The authors estimated a production weight of a HHC system of 0.5% of the aircraft's weight. Further investiga-

² In August 1972, the US Army cancelled Lockheed's compound helicopter programme AH-56A Cheyenne.

tions on methods for optimising single and multiple HHC blade feathering inputs to attenuate single or multiple vibratory forces and moments, respectively, can be found in [18]. The methods presented are applied to data gathered during a wind tunnel test campaign that has been conducted to systematically support the development of the flightworthy HHC system that has been used for the flight tests on the OH-6A of ref. [17]. The tests were performed in the 16ft NASA/Langley transonic dynamic wind tunnel using a 9ft diameter, aeroelastically scaled, articulated 4-bladed model rotor. [Figure 12](#) shows a typical result from their wind tunnel tests using $4/rev$ collective control to reduce $4/rev$ normal force of the rotor. The HHC amplitude was held constant at $\vartheta_4 = 0.5^\circ$ while the phase was varied. The graph with HHC application (red line) forms an ellipse around the uncontrolled case (Baseline) and encloses the origin (i.e. no vibrations). It can be stated that the applied amplitude has been too large. A perfect amplitude would result in an ellipse that crosses the origin and hence would eliminate all normal force vibrations at the optimum phase. The optimal control settings were reported to be 0.22° amplitude and 30° phase and were obtained by manually changing first phase and then amplitude. This control setting does not cancel all vibrations (stochastic fluctuations during the measurements contribute to this), although the resulting vibration reduction in normal force is rather good.

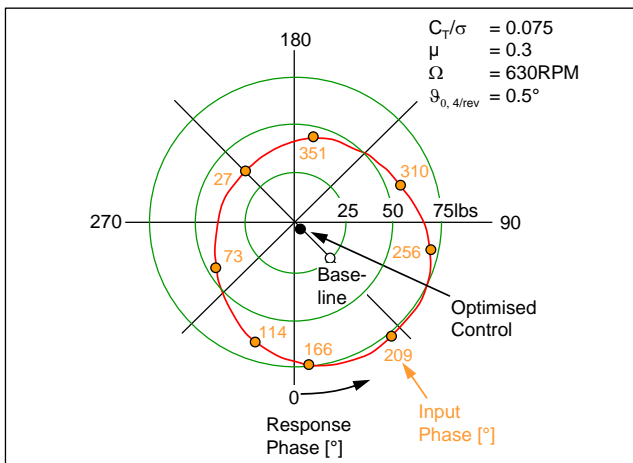

Figure 12: Variation of $4/rev$ normal force of model rotor with $4/rev$ input phase.

The optimised HHC setting did not have negative impact on in-plane and out-of-plane bending moments, but on torsional moment. An analysis of the harmonic content of blade torsion revealed a large increase in the $4/rev$ and a slight increase in 3 and $5/rev$ harmonic of the torsional moment when compared to the baseline case. In addition to this test HAMMOND [19] used the same wind tunnel model setup, applying now closed loop HHC. He tested four different controller concepts which were based on Kalman filter algorithms to identify the unknowns of equation (5), which is discussed briefly below. A general discussion of adaptive and non-adaptive controllers including the four controllers and the Kalman filter identifier used by HAMMOND, respectively, can be found in [20]. Target vibrations were vertical force, pitching and rolling moment measured by a balance fixed to the rotor shaft. Again, HHC could significantly reduce vibrations over a wide range of advance ratios. However, again, an increase in edgewise

bending moment, torsional moment and control loads was discovered.

The first flight of the modified OH-6A with HHC using 3 to $5/rev$ blade feathering was conducted in 1982 [21], more than 20 years after Bell's flight tests [15]. A photo of the HHC system is shown in [Figure 13](#). The HHC actuators were installed in the stationary system where they replaced conventional rod-end links between the control mixer and the stationary swashplate. This design shows a remarkable simplicity when compared to IBC systems. Vibrations were measured at the pilot's seat in all three directions.

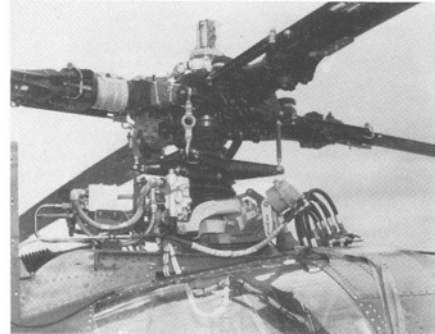

Figure 13: HHC system on OH-6A, right lateral actuator installed between mixer and swashplate.

The actuators were designed to have a stroke of ± 0.2 in (0.58cm) or $\pm 2^\circ$ blade angle. Since tests performed prior to flight testing indicated that this was probably more than required, a limit of $\pm 0.75^\circ$ was established electronically. Flight testing with open loop and closed loop HHC covered speeds from hover to 100kts as well as manoeuvring flights (turns, flares acceleration, deceleration). To control vibration, the closed loop approach was based on the well known T-matrix approach

$$(5) \quad Z_i = Z_{i0} + T_{ij} u_j$$

where Z_i is a 6×1 vector of the measured vibrations (3 sine and 3 cosine components, for example at the pilot's seat), Z_{i0} is a 6×1 vector of baseline vibrations and T_{ij} is a 6×6 matrix relating the relative change in vibration levels to the HHC inputs and u_j a 6×1 vector of the HHC inputs (3 to $5/rev$ in sine and cosine). Such a purely linear relation as given in equation (5) would generate a perfect ellipse about the baseline condition in [Figure 12](#). A Kalman filter technique was used to estimate the unknown terms in equation (5). The estimation of the T-matrix requires an identification process which usually requires a phase sweep from 0° to 360° . The drawback is that this initialising process may cause annoying variations of the vibration level to pilots and passengers. However, the authors reported that this was not the fact. In addition, the control approach turned out to be very robust. [Figure 14](#) and [Figure 15](#) show the $4/rev$ vibration level as a function of airspeed with and without closed loop HHC and the corresponding control amplitudes of the three HHC frequencies 3, 4 and $5/rev$. As can be seen, the vibrations can be reduced for all three axes except for the longitudinal vibrations starting from 65kts. This is tolerable, since the longitudinal vibrations are rather small compared to the vertical vibrations. In general, the overall vibration level decreases significantly. The required amplitudes for the three controlled frequencies remain

small and vary slightly with speed. While at low speed $3/rev$ HHC dominates the amplitudes, at higher speed all three harmonics show similar amplitudes. This result has been achieved without undue increase of blade loads or adverse flight performance. Although the flight tests were not intended to address specifically performance, it turned out to be quite the contrary. Instrumentation to measure rotor and engine torque revealed slight reductions in both parameters with HHC engaged.

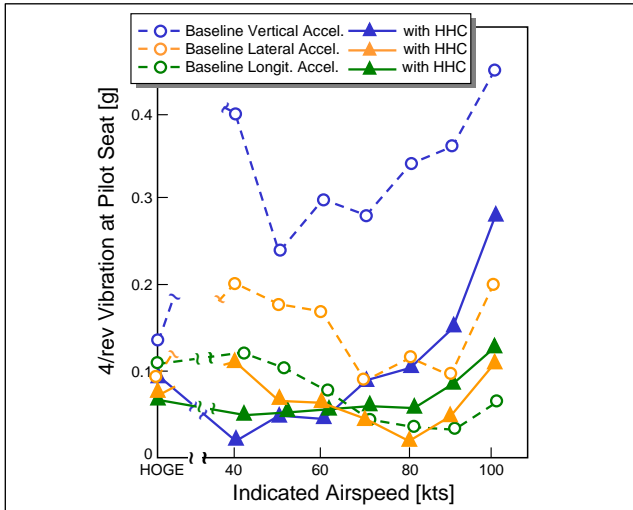

Figure 14: Pilot’s seat vibrations with and without HHC in level flight.

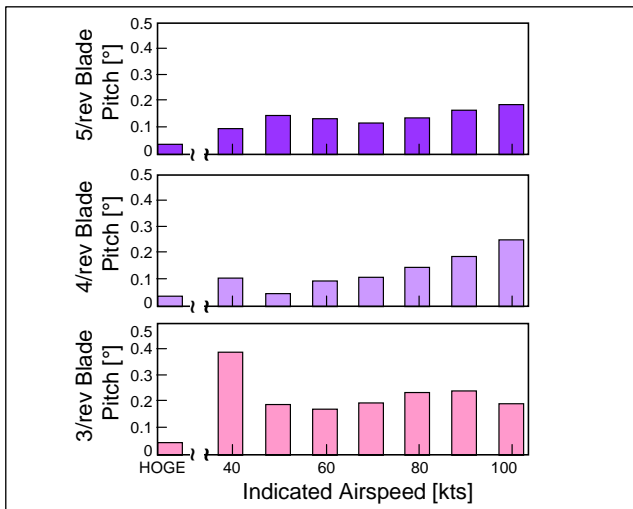

Figure 15: Blade feathering amplitudes for minimum vibrations.

A theoretical comparison of HHC applied to a 2-bladed see-saw rotor helicopter and to a 4-bladed hingeless rotor helicopter for vibration reduction is given in [22]. For the two-bladed teetering rotor, cancellation of $2/rev$ hub vertical shear forces using $2/rev$ collective HHC was considered, while for the 4-bladed one the minimisation of $4/rev$ vertical shear force, rolling and pitching moments using 3 to $5/rev$ HHC was studied. The results indicated that some vibration reduction is possible for both rotors. Optimal HHC amplitudes and phases varied significantly with forward speed for the hingeless rotor while there was only an amplitude variation at almost constant phase for the teetering rotor. For the 2-bladed Rotor, this is in contrast to [15], see [Figure 11](#). Penalties on rotor power as well as pitch link

loads were predicted for both helicopters. This drawback was more pronounced for the teetering rotor.

Wind tunnel test results of closed loop HHC for vibration reduction applied to a 4-bladed soft-inplane hingeless model rotor are presented in [23] by SHAW and ALBION. The model rotor was dynamically scaled to an early version of the Model 179 of Boeing Vertol. Max. authority of the HHC system was $\pm 1.5^\circ$ blade feathering. Open loop tests confirmed an almost linear relation between vibrations and HHC inputs. However, a strong impact of advance ratio on HHC amplitude and phase was noted which indicates that a constant gain controller (elements of T-matrix fixed) would not provide satisfactory HHC performance. Instead of using feedback signals from a rotor balance, measurements from the rotating frame were used. The feedback variables were 3, 4 and $5/rev$ components of blade root flap bending. The 3 and $5/rev$ flap bending moments lead to $4/rev$ hub moments in pitch and roll in the fixed frame and $4/rev$ flap bending moments result approximately in a $4/rev$ vertical forces at the hub centre (the latter approximation is not fully correct) Trim conditions covered level flight from hover to $\mu = 0.3$, 67% and 133% normal gross weight at $\mu = 0.2$ and autorotation at $\mu = 0.2$. Vibration reductions of 90% at $\mu = 0.2$ were achieved, while the HHC system was less effective at lower speeds. This was caused by blade pitch requirements larger than the authority of the actuators. It was concluded that the actuator authority should be increased to $\pm 3.0^\circ$. From transient responses of the closed loop system it was concluded that the system should be fast enough to also suppress varying vibrations caused by gusts and manoeuvres. In this study, too, a slight drawback on rotor performance turned out (HHC was optimised for vibration reduction). HHC also turned out to adversely affect pitch link loads. However, it was concluded that this would not be a problem, since pitch links would usually be designed to withstand much higher loads at blade stall. Nevertheless; this effect should be taken into account in future testing. In addition chord bending moments were increased, especially when applying $5/rev$ HHC, at some test conditions, since this control frequency was close to the second in-plane bending eigen frequency. Proper blade design should alleviate this penalty.

In a further study, SHAW and ALBION et al. investigated closed loop HHC for a 3-bladed, articulated model scale CH-47D rotor [24]. Vibratory loads were measured in the rotating system by a strain-gauge balance. Feedback signals were the $3/rev$ vertical force and the 2 and $4/rev$ rotating in-plane hub shears. Due to the 3-bladed rotor, HHC is fully capable of IBC as explained in section 3. Using even a fixed-gain controller, a simultaneous 90% reduction of $3/rev$ hub vertical and 2 and $4/rev$ in-plane shear forces was achieved up to speeds of 188kts. This result was maintained as rotor operating conditions were changed as rapidly as possible. The suppression was also demonstrated for variations in thrust and propulsive force, hence representing changes in weight, load factor, flight path angle etc. A $2/rev$ HHC input was also investigated for performance improvement. The power required in trim was reduced by 6% at 135kts and 4% at 160kts. It should be noted, however, that $2/rev$ for a 3-bladed rotor can not be optimised

purely for performance improvement, since for such a rotor it is essential for vibration suppression as well.

A somewhat “exotic” application of HHC is given in [25]. Here, the effect of HHC on the co-axial Sikorsky Advancing Blade Concept (ABC) rotor was studied. The two rotors featured three very stiff blades each. For such an aircraft, the vibration reduction task becomes more challenging in general due to large rotor speed variations (up to 25%) and speeds of up to 300kts. On the other hand, the authors claimed a unique advantage of the ABC system compared to conventional helicopters (which have six vibratory force and moment components in the fixed frame), since it generates just three vibrators loads due to interior cancellation between both rotors. This should make the application of HHC for vibration reduction easier than for conventional helicopters. Indeed, in theory, it should be possible to control three vibration components using three HHC frequencies (i.e. 2 to 4/rev for the ABC). When 2/rev HHC was used, a re-trim of the aircraft was required since the 1/rev trim loads were affected. Nevertheless, the authors predict a vibration reduction of up to 90% of the baseline vibrations using an authority of 0.5° to 2° depending on the HHC frequency. The authors also explained the installation of a HHC system on the XH-59A research aircraft.

In [26], a state-feedback controller approach is presented for vibration reduction in contrast to controllers based on quasi-steady formulations (like equation (5) and its identification of unknown parameters). The analysis was validated on an RSRA (Rotor Systems Research Aircraft) simulation. A major barrier to the application of state feedback for HHC was seen in the fact that all frequencies were contained in the state measurements. A control law tailored to minimise one specific frequency content could negatively affect others. As a solution, second-order, un-damped oscillators tuned to the desired frequency at n/rev were introduced to the feedback loop, see Figure 16.

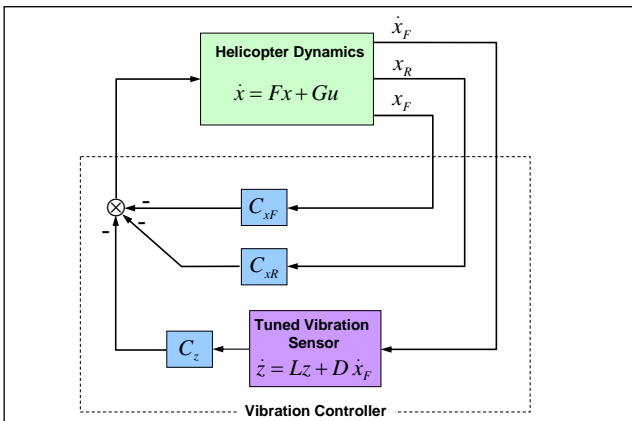

Figure 16: State feed-back vibration controller, $x_F, x_R =$ fuselage and rotor states, $z =$ filter states, $C =$ feedback gain.

The authors pointed out, that the resulting system would act like a phase-locked loop, since the control signal would be 180° out of phase with the vibrations at the filter’s resonant n/rev eigen frequency. Using such filters, the controller would be able to lock on to vibration phase and amplitude without any harmonic analysis. The robustness of the algorithm was demonstrated by its ability to effectively reduce

vibrations over a wide range of forward speeds using a controller designed for hover. However, the models included no fuselage flexibilities.

A first wind tunnel test exploring the effect of HHC on a 4-bladed Mach scaled, soft-inplane, hingeless BO105 model rotor has been conducted in the DNW (Deutsch-Niederländische Windkanäle) in 1984. A summary of the results is given by LEHMANN in [27]. Here, open loop HHC has been applied at fixed amplitude and varying phase. The following cost function was defined:

$$(6) \quad CF = \sqrt{z^T W z}, \quad z^T = (F_x, F_y, F_z, M_x, M_y)$$

$$W = \text{diag}(1/N^2, 1/N^2, 1/N^2, 1/(Nm)^2, 1/(Nm)^2)$$

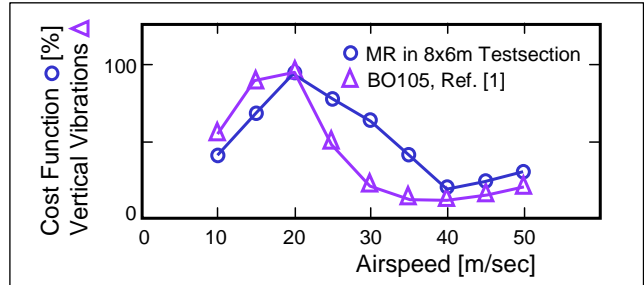
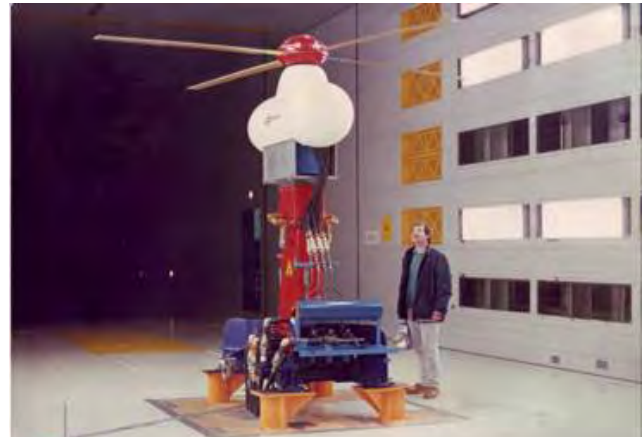

Figure 17: Comparison of cost function vs. tunnel speed compared to data from ref. [1].

Testing was done at 20m/sec, since vibrations turned out to be a maximum at that speed. This is shown in Figure 17. The figure shows model (top) and a comparison of the cost function and vertical vibrations versus speed received from wind tunnel and free flight condition (bottom). The model predicts the same speed for maximum vibrations. Initially, the three HHC frequencies were controlled separately. 3/rev could

- reduce all balance forces and moments by more than 50% simultaneously,
- required an amplitude $A_3 > 1^\circ$ for maximum vibration reduction,
- changed the spectral components of the flap bending moment, 2/rev content is increased significantly, 1/rev slightly, others are reduced,
- had an impact on the trim state,
- had a non-linear effect on vibrations which depends on amplitude and phase.

As an example, Figure 18 shows the effect of 4/rev on the cost function, the left figure for two different amplitudes

and varying phase, the right figure at varying amplitude at the optimum phase. As can be seen, the optimal phase is a function of the amplitude.

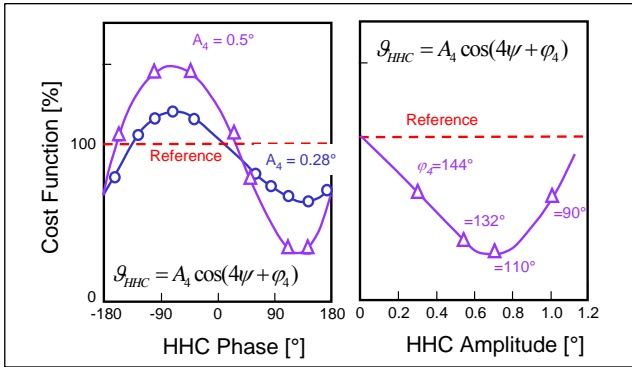

Figure 18: Cost function for 4/rev HHC.

4/rev could

- reduces all balance forces and moments significantly and simultaneously, most effective was the reduction of lateral force by 94%,
- required approximately 30% smaller amplitudes than 3/rev at similar results,
- had no adverse effect on flap bending moments, all harmonics were reduced.

Finally, 5/rev reduced all balance forces and moments simultaneously, but was less efficient when compared to 3 and 4/rev and increased the 3/rev flap bending moment. Finally, multi-harmonic HHC was applied, but the method to optimise amplitudes and phases was too simple to obtain an optimum vibration reduction. Comparing his results to ref. [23], LEHMANN confirmed that a hingeless rotor with low first torsion eigen frequency would need large control angles at the low speed region. He concluded that the first torsion eigen frequency would dominate the HHC efficiency. From today's point of view, this conclusion is valid also for IBC. However, it seems to be desirable, to excite the torsional motion by IBC to achieve sufficient blade tip deflections. And this is more pronounced for torsional soft blades.

LEHMANN's work was conducted by [28]. Here, too, wind tunnel tests were done using a Mach-scaled BO105 model rotor in DNW (1986). In addition to open loop testing, closed loop HHC was used. Using just 3/rev, the controller was capable in reducing all 4/rev balance vibrations (no torque vibrations considered) simultaneously. Adding 4/rev HHC further reductions were achieved.

Using the same model rotor, a further test campaign was conducted in 1988. Although these tests were not specifically dedicated to noise investigations, some supplementary effort was conducted to investigate the impact of HHC on Blade Vortex Interaction (BVI) noise reduction using 3 to 5/rev HHC [29]. Maybe, these tests were the first acoustic HHC wind tunnel tests. Tests were performed in the 6mx8m closed test section. Based on previous rotor acoustics tests in the open-jet configuration, two microphones were placed in the test section floor, one at the advancing side, one at the retreating side, where maximum BVI noise radiation was to be expected. Here, blade and vortex axes

are close to parallel. The acoustic measurements on noise reduction might be treated carefully, since noise reductions may be caused by a change of noise radiation directivity and not by manipulating BVI noise itself. The preliminary results indicated that three basic parameters of BVI noise generation were affected by HHC. At optimum control settings the blade loading was decreased and the blade vortex miss-distance was increased over the azimuth range of almost parallel BVI in first (between 40° to 95° at the outer span) and fourth quadrant. The vortex strength was increased due to increased blade loading at its point of generation at $\psi \approx 120^\circ$. Noise reductions were as high as 4 to 5dBA. However, this was on the cost of a vibration increase. Initially it was assumed, that both effects could be affected favourably at the same time. One example of HHC impact on BVI noise is shown in Figure 19. Here 3/rev turned out to be most effective. At slightly lower advanced ratio ($\mu = 0.138$), 4/rev was best.

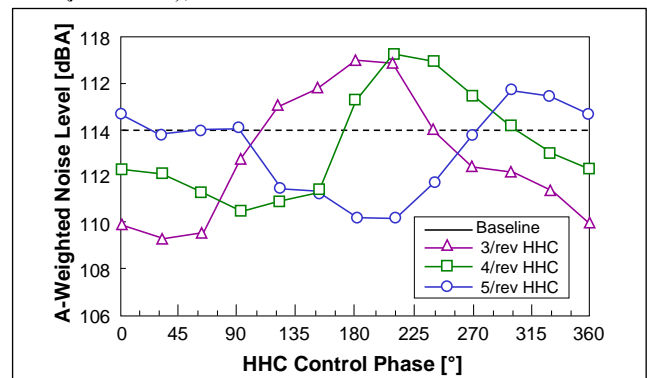

Figure 19: HHC effect on BVI noise level, advancing side microphone, $\mu = 0.161$, HHC amplitude 0.4° each.

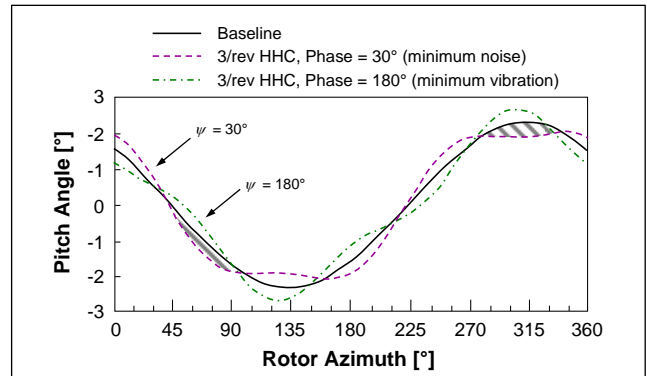

Figure 20: Measured harmonic pitch root angles with and without and different 3/rev HHC, $\mu = 0.161$.

The difference in harmonic blade feathering of 3/rev HHC for minimum noise and vibration reduction can be seen in Figure 20. It becomes evident that the blade pitch is decreased for minimum noise compared to the case without HHC (see shaded areas at $\psi = 40^\circ$ to 95° and $\psi = 280^\circ$ to 340° , i.e. the areas of nearly parallel BVI events). This decrease of the blade root pitch angle leads to an unloading of the rotor. Unloading of the rotor in the azimuthal ranges of strong BVI is therefore one explanation for BVI noise reduction potential of active rotor control. More explanations on the noise reduction mechanism can be found in context with the summary of the results of ref. [39] and [40], see below. In contrast, optimum vibration HHC settings turned out to adversely influence the BVI relevant parameters mentioned above, resulting in 3 dBA increase of

noise level. Figure 20 shows that the blade pitch angle is increased for optimum vibration reduction at $\psi = 30^\circ$ to 90° and $\psi = 270^\circ$ to 330° .

Further flight tests were performed by Aerospatiale in 1985 on a SA349 Gazelle with a 3-bladed articulated rotor [30]. Based on the T-matrix approach of equation (5), the HHC system featured a closed loop self adaptive controller. Three different approaches to compute optimal HHC inputs were studied. The first implies a prior (and may be repeated) identification of the T-matrix, the others do not, since a permanent identification of T is used. The maximum controllable blade feathering angle through HHC was $\pm 1.7^\circ$, however, the controllable amplitude has been limited to $\pm 1.0^\circ$ or less. Later-on, it turned out that larger HHC authority would have resulted in higher vibration reduction. Two configurations of the SA349 were tested. One with passive vibration reduction means, the other one with blocked ones. Accelerometers measured vibrations in vertical and longitudinal axis in the forward section of the cabin and on vertical axis at pilot and co-pilot stations. A typical result using one of the two adaptive HHC algorithms (RASEV, see [30] for more details) is shown in Figure 21.

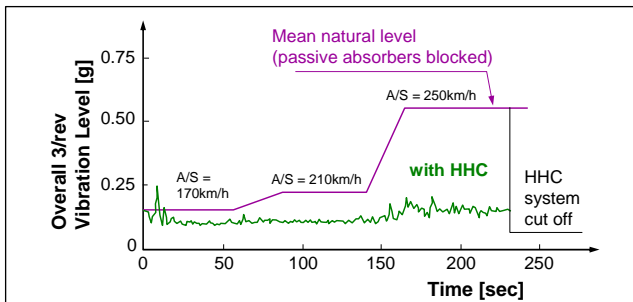

Figure 21: Closed loop HHC result using RASEV algorithm.

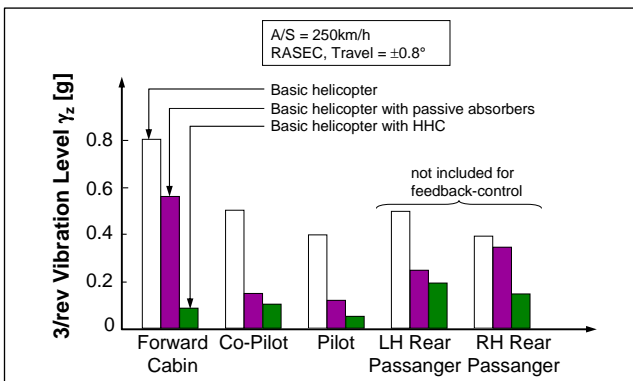

Figure 22: Comparison of vibration levels.

The HHC system was also tested in turns and operated well. Finally, the authors compared the HHC results to the passive vibration reduction system installed in the SA349. The HHC results resulted in equivalent or much better vibration levels, see Figure 22. Although the left and right hand passenger stations were not included in the vibration optimisation procedure a reduction at both stations with HHC has been achieved.

A summary of 10 years research and development on HHC at Aerospatiale is given by POLYCHRONIADIS [31]. In addition to the above mentioned vibration aspects, HHC was also investigated for BVI noise and performance im-

provements. For this, the aircraft was fitted with microphones, see Figure 23. The HHC algorithms optimised for vibration reduction were tested as well as open loop HHC with systematic amplitude and phase variation. For the open loop HHC, noise reductions were reported up to 3.5dBEPN (EPNL: Effective Perceived Noise Level). Even with the vibration controller, noise reductions were achieved at some flight conditions. Both results, especially the latter one, have to be considered carefully. As shown later, the simultaneous reduction of noise and vibration by means of HHC is difficult. Skid mounted microphones do not necessarily reflect the noise signature on the ground. This has to be proven prior to flight testing, since the control inputs might not reduce the BVI noise level, but might change the direction of noise emission.

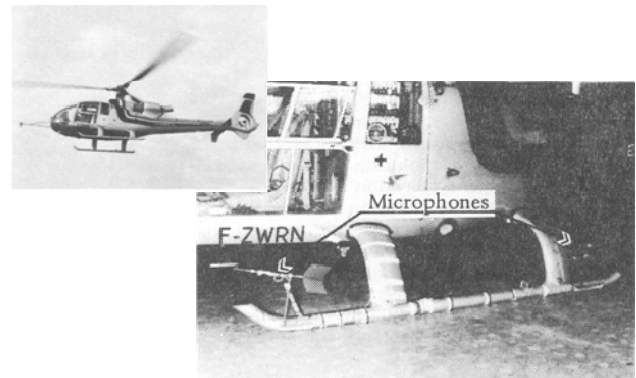

Figure 23: Microphones installed on the SA349.

Theoretical predictions based on a simulation model of the 4-bladed SA365N were performed to explore the potential on performance improvement. A $2/rev$ control turned out to be most effective (note: a $2/rev$ for a 4-bladed helicopter can only be controlled by IBC). Nevertheless, the performance gain for existing helicopters in cruise was judged to be small. The amplitude requirements were frequently higher than 4° . These studies were complemented by wind tunnel tests. However, since rotor static loads with HHC were not the same as for the baseline case without HHC, conclusions with respect to performance improvement are difficult.

Open loop HHC flight testing on a S-76 helicopter up to forward speeds of 150kts has been conducted also by Sikorsky in the 1980ies [32]. Further tests were performed in climb, descent and turns. Main focus was on vibration reduction. Further aspects were control system wear due to HHC. The three HHC actuators replaced fixed system control rods. Each HHC actuator moved the primary servos which in turn moved the swashplate. Although the vibration characteristics of the aircraft were mentioned to be "extremely good" the passive absorbers (bifilars in the rotor and a variable tuned fixed system vibration absorber) require 2.75% of the design gross weight (10,500lbs). The passive absorbers were either removed or turned off. Figure 24 shows reduced cockpit vibrations in level flight and during manoeuvres. The vibration reduction capability is almost constant versus speed. Vibration levels of 0.1g were achieved up to 100kts, but then begin to increase with speed due to control saturation. Without such limitations vibration levels of less than 0.1g would have been possible at higher speeds. The manoeuvre flight data were obtained by using the optimum HHC settings determined for level

flight and this setting was then held constant during the manoeuvre. The results are quite remarkable for such a crud approach. Structural data showed that vibratory loads (e.g. pushrod loads) increased, but were not large enough to be limiting. The power to drive the collective mode and longitudinal tilt of the swashplate for HHC application was mentioned to be 144hp and 40hp, respectively. The weight of an HHC system with $\pm 2^\circ$ pitch authority was estimated to be 115lbs. Servo actuator bench testing revealed no unusual wear or leakage after 50 million HHC cycles.

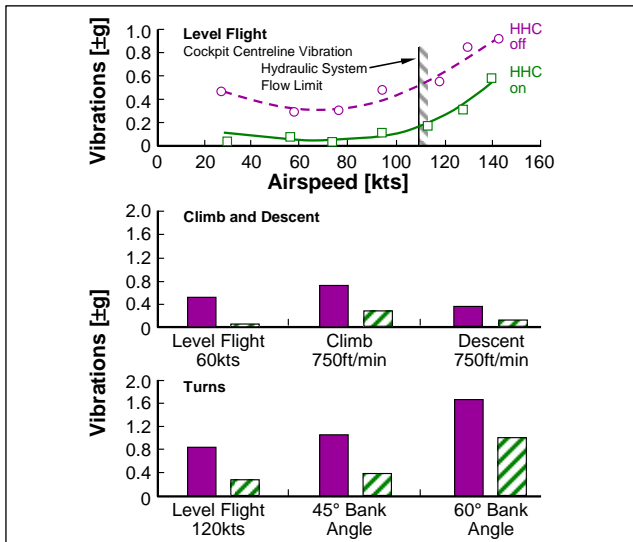

Figure 24: Vibration reduction on S-76 by HHC.

Further theoretical comparisons of fixed-gain versus adaptive gain HHC for vibration reduction can be found in [33]. Even when incorrectly initialised, the adaptive algorithm could quickly adapt itself. The adaptive gain HHC also worked well in manoeuvring flights. The fixed-gain controller turned out to be effective only, when speed changes were less than 20kts.

A theoretical sensibility analysis of different parameters on HHC efficiency is presented in [34]. The analysis was based on finite element methods, non-linear unsteady aerodynamics and free wake modelling. The model was validated with data from [24]. The analysis revealed, that HHC optimised for vibration reduction might penalise stall for rotors operating near the flight envelope and hence has adverse impact on rotor performance. In this respect, this study confirmed results of [22]. The sensitivity analysis showed that for a rotor operating at high thrust and high speed blade torsion stiffness (soft blades increase actuator power), offset of blade-centre of mass from elastic axis (c.g. far ahead of e.a. is favourable) as well as offset of elastic axis from blade quarter-chord (small and large offsets ahead of $c/4$ are unfavourable) effect actuator power requirement.

Testing of a dynamically scaled 4-bladed articulated rotor model in NASA Langley's Transonic Dynamic Tunnel using heavy gas (R-12) is presented in [35]. Twelve fixed microphones (six upstream, six downstream of the rotor) were used in the closed test section. No special acoustic treatment of the reverberant wind tunnel walls was conducted. Here, $4/rev$ HHC has been used to reduce noise and resulting vibrations were monitored. The outcome is a

maximum reduction of 5.6dB at a lower speed descent condition (descent angle of 8.5°). At such conditions, BVI is most intense. No noise benefit has been observed outside such flight conditions. However, while HHC reduced mid-frequency BVI noise, it increased low-frequency loading noise levels, see [Figure 25](#).

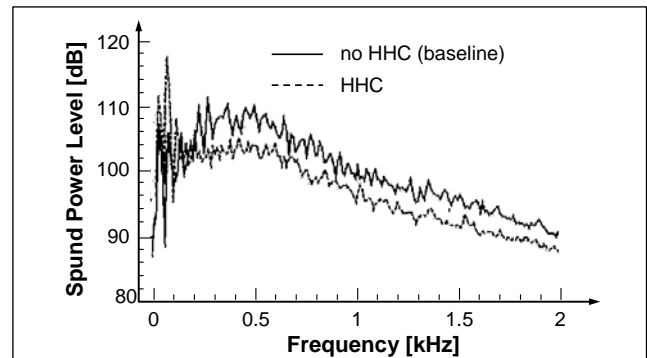

Figure 25: Sound power spectrum, $\mu = 0.11$ $\Theta = 10.5^\circ$, $4/rev$ HHV at $\vartheta_4 = 1.2^\circ$, Phase $\varphi_4 = 60^\circ$.

Based on a subjective A-weighted (dBA) measure, the authors noted, this might be of less importance, when significant BVI mid-frequency noise reductions can be achieved. For military detection concerns, this might be different. The use of HHC for noise reduction was found to increase vibrations.

A summary of the results of the first HHC rotor aeroacoustic test in an anechoic environment is given in [36]. Partners of this international campaign exploring noise reduction potential and vibration impact were DLR, NASA and MBB. The rotor was a 40% Mach and dynamically scaled model of the BO105 main rotor. With a diameter of 4m. Advancing and retreating side BVI source locations were identified in preceding test in the first quadrant between 45° and 75° azimuth and in the fourth quadrant at about 300° . An array of eleven microphones and three further in-flow microphones were used to measure noise signatures underneath and next to the rotor (area $5.4\text{m} \times 8\text{m}$) to overcome the drawbacks of previous noise measurements. HHC turned out to have only minor impact on the trim condition in this test. The highest noise reduction was achieved in low speed descent flights at $\mu = 0.15$ and $\Theta_{FP} = -6^\circ$ descent angle. Up to 6dB noise reduction was achieved on the advancing side using $4/rev$ HHC at 1.2° amplitude and 30° phase angle (the definition of the phase angle is the same as in [35]). On the retreating side BVI, noise levels were slightly increased. At 180° phase both noise spots were reduced simultaneously, at the retreating side even by 6dB. However, the advancing side shows the highest baseline noise levels of approx. 115dB while the retreating side of just 110dB, approximately. Hence, a HHC input that minimizes advancing side noise as much as possible and reduces retreating side noise simultaneously (or at least without penalising retreating side noise) would be most beneficial. This dilemma can be solved using $3/rev$ control (1.2° amplitude and 332° phase angle) giving noise reduction of about 5-6dB on both sides. $5/rev$ HHC turned out to be less effective than 3 and $4/rev$. Less or no noise reduc-

³ Please note: the definition of the HHC phase in [35] differs from the notations of this paper.

tion outside the BVI intensive flight conditions was discovered. The use of HHC increases low frequency loading noise, but this was considered to be of no concern, see [35]. Also, vibrations increased especially for HHC settings most beneficial for noise reduction and vice versa. A number of HHC settings were found to simultaneously reduce noise and vibrations, but on the expense of less reduction of both parameters. Due to of this problem, IBC was mentioned to be highly desirable. In this respect, the conclusions on HHC benefits were similar to [29].

Wind tunnel tests have been conducted by ATIC in 1998 and 2000 in the DNW [37], [38]. Both tests were not exclusively dedicated to HHC, but also on testing of different blade designs, blade numbers, rpm variations etc. to investigate performance, noise and vibrations. HHC effect on BVI noise was in both tests analysed for a fully articulated 5-bladed rotor with 2m radius using rectangular blades with NACA23012mod. airfoil. For details on test instrumentation see both references. Ref. [atic-1] shows results of $6/rev$ HHC on BVI noise during a descent condition ($\mu = 0.16$, $\alpha = 4.72^\circ$, $C_T = 0.0064$). At an HHC input of 0.4° amplitude and 0° phase (azimuth where HHC blade pitch becomes a minimum) 3dB reduction in overall sound pressure level was achieved. LLS technique revealed a change in the vortex trajectory. While the horizontal path of the vortex was almost not altered by HHC, the vertical was. This finally led at the important position of 60° azimuth to an inward shift of the blade-vortex-interaction point. Without HHC the collision point was at about 80%R, with HHC at 72%. Ref. [atic-2] mentions a potential of up to 6dB BVI noise reduction by HHC.

Two of the most successful wind tunnel tests have been conducted within an international Trans-Atlantic cooperation and known shortly as HART (Higher Harmonic-Control Aeroacoustic Rotor Test) [39], [40] and HART II [41]. Although just vibration and noise reduction aspects were in focus as for so many other studies, these two wind tunnel campaigns gathered more data thanks to highly instrumented test equipment compared to the tests described before. These data are still in use today to validate simulation codes and to explore the aerodynamic and aeroacoustic physics of the phenomena covered by HHC. Data are now partly open to the public and the HART II International Workshop is still held twice a year in conjunction with the AHS and ERF conferences.

The first HART test was conducted in 1994 in the DNW 8mx6m open test section [39], [40]. Partners were NASA Langley, US Army AFDD, Onera, DNW and DLR. The newly manufactured model was similar to [36], but showed a slightly different steady and dynamic behaviour. The installation is shown in [Figure 26](#). In addition to various microphones for acoustic radiation measurements a wide variety of sensors were installed: blade pressure sensors and strain gauges, Laser Doppler Velocimetry (LDV) for vortex strength and core size, Laser Light Sheet (LLS) for vortex geometry and blade-vortex miss distance measurement, projected grid method (PGM) for blade deflections, etc. During this campaign, $3/rev$ turned out to be clearly more effective in reducing BVI noise than 4 and $5/rev$. Retreating noise was reduced for many phase angle set-

tings, while advancing side noise was reduced or increased depending on the phase. The controlled HHC amplitudes were somewhat lower than the maximum controlled HHC settings mentioned in [36]. Noise contour plots for the baseline (BL) case and two cases using HHC for minimum noise (MN) and minimum vibration (MV) are shown in [Figure 27](#).



Figure 26: HART test installation in DNW.

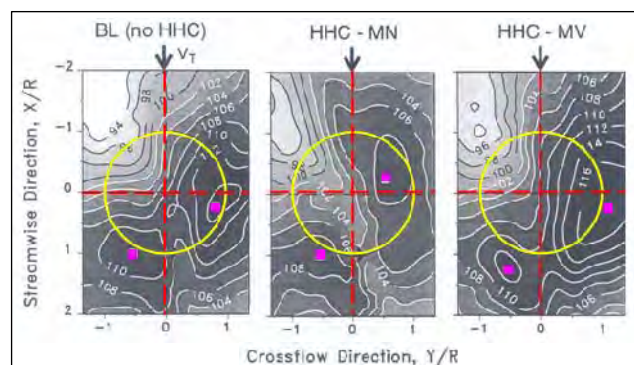

Figure 27: Noise carpets without and with HHC, MN = Minimum Noise, MV = Minimum Vibration, $3/rev$, $\vartheta_3 = 0.85^\circ$, \blacksquare = “Hot Spot”, $\mu = 0.15$, $\Theta_{FP} = -6^\circ$.

They clearly show the drawback of the MV case on the noise level. The $3/rev$ control for minimum noise (HHC amplitude 0.85° , phase angle 296° , the definition of the phase angle is again the same as in [35]) reduced the noise level on the advancing side by 6dB (about 50% of the maximum BVI level) while a simultaneous reduction on the retreating side of 2-3dB was achieved. A second minimum for reducing noise on both sides was observed at 84° phase angle. Maximum reduction on the retreating side was 4.5dB at 326° phase angle. The “minimum” vibration case (amplitude 0.85° , phase angle 177°) resulted in about 30% vibration reduction. To reduce vibrations, much lower amplitudes are usually applied. For this test, the amplitude was kept constant to 0.85° (the value used for sufficient BVI noise reduction) and just the phase was varied till a minimum in vibration level was found. An illustrative representation of both aerodynamic and aero-acoustic results is given in [Figure 28](#). High pass filtered leading edge $\Delta C_p M^2$ distributions in the rotor plane as well as the related BVI noise contours below the rotor are shown for the baseline case (left) and the minimum noise case with HHC (right). The BL case illustrates strong pressure fluctuations in the first and fourth quadrant which are responsible for the two spots of high noise levels below the rotor (red to violet colour). These pressure fluctuations between 40° to 60° azimuth have been significantly smoothed for the MN case, hence reducing the two “noise hot spots” of the BL case tremendously.

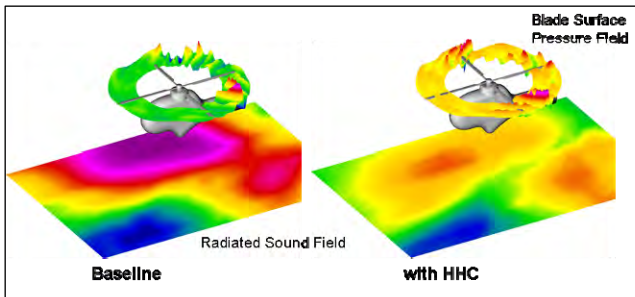

Figure 28: High pass filtered leading edge $\Delta C_p M^2$ distributions in the rotor plane and BVI noise contours for BL (left) and MN (right), $\mu = 0.15$, $\Theta_{FP} = -6.6^\circ$.

As mentioned, the value of the HART campaigns are the data base still in use today. One important result for example, is the noise reduction mechanism: increasing blade-vortex miss-distance was shown to be most important, followed by unloading the blade at the interaction, while vortex strength was found to be increased. The miss-distance itself was dominated by aerodynamically induced tip vortex convection rather than by blade flapping [40], i.e., the vortex draws aside the blade and not vice versa.

As a consequence, the key parameter for noise simulation is the wake simulation. The understanding of the mechanisms will support the design of robust control laws. Since very little data existed for vortex modelling itself (i.e. its roll-up process and its behaviour afterwards) even after HART, the same team formed again to launch the HART II test. This was conducted with a 40% scaled BO105 model rotor in 2001, again in the open-jet test section of DNW. This time, even more and rather new techniques were applied to measure the rotor wake and its development within the entire rotor disk. Double Stereo Particle Image Velocimetry (PIV), Stereo-Pattern Recognition (SPR), Blade Tip Deflection (BTD), which allowed cross-checks with SPR, blade mounted pressure transducer and strain gauge signals from every blade etc. were used. Noise was measured by 13 microphones on a traverse, two in the nozzle and three at the ceiling. An overview on the project can be found in [41] and is representative for 80 HART II related publications, gathered so far⁴. Figure 29 shows PIV and SPR raw data images. SPR marker accuracy was 0.5mm, giving a torsional precision of 0.5° . The intensity as well as the directivity of noise radiation turned out to strongly depend on flight path angle with a maximum at 6° at $\mu = 0.15$. The paper mentions the following optimal phase angles at a $3/rev$ amplitude of 0.8° : for minimum vibrations (MV) 180° and minimum noise (MN) at 300° . This is in good correlation with the values for MN and MV given in [40] although the rotor used for HART II showed slight differences in torsion due to a different design of the main spar. Figure 30 shows $10/rev$ high pass filtered blade pressure data for the baseline case, MV and MN. The largest baseline pressure fluctuations occur at $\psi = 45^\circ$ on the advancing side where blade and vortex are parallel. On the retreating side, strong BVI occurs at the tip around 300° azimuth. For the MV case, noise radiation levels are increased, since the blade-parallel BVI events are intensified and additionally shifted to the blade tip, where the local Mach numbers are

larger. In the MN case, BVI is shifted towards more in-board radial locations. At the outer radii of the blade, the vortices are already located far below below the disk and do not cause any BVI, thus reducing the noise radiation.

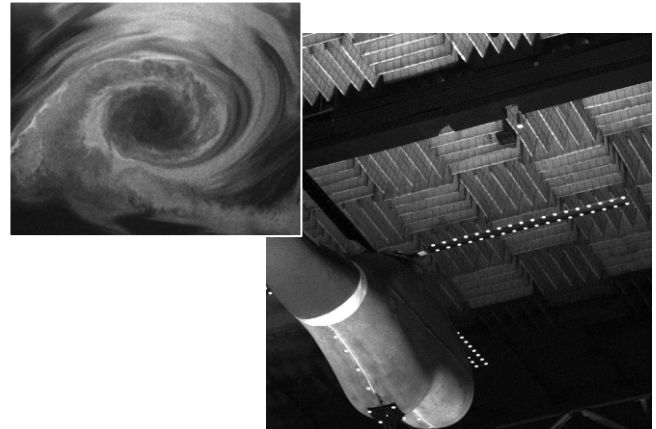

Figure 29: PIV and SPR raw data image.

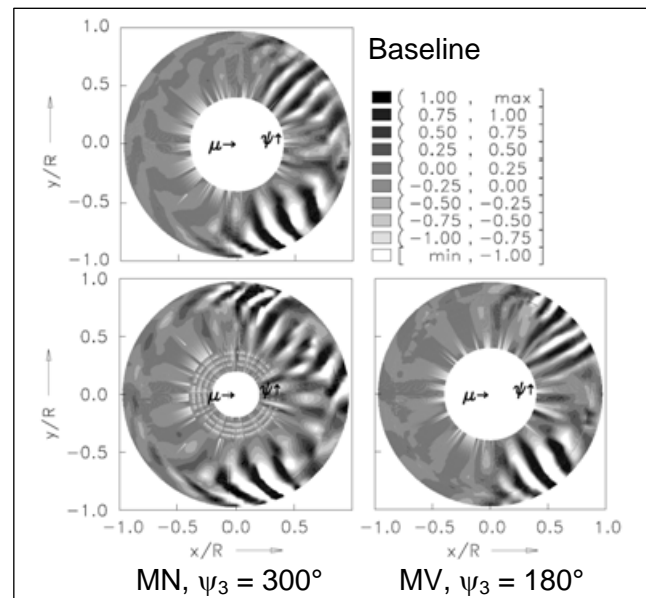

Figure 30: Leading edge pressure distributions w/o and with HHC, $3/rev$, $g_3 = 0.8^\circ$, $\mu = 0.15$, $\Theta_{FP} = -6^\circ$.

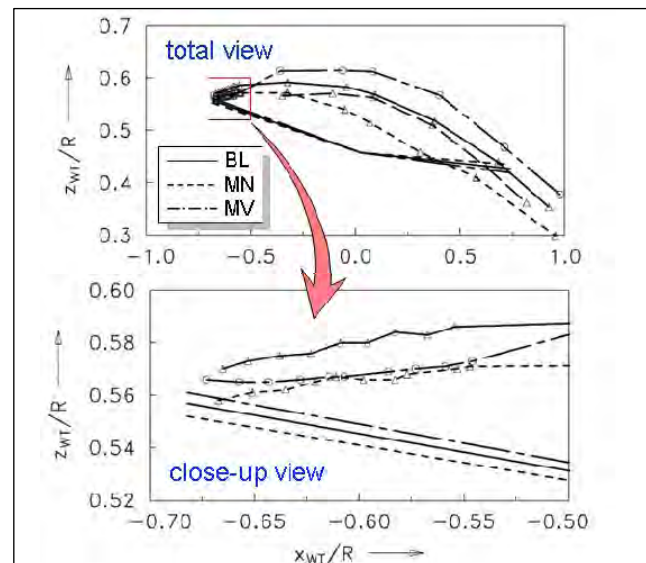

Figure 31: PIV vortex flight path analysis, $y = 0.7R$, Δ : conventional vortex, O : counter rotating vortex.

⁴ June 2010

An impression of the vortex flight path in a lateral plane at $y = 0.7R$ is given for BL, MN and MV in [Figure 31](#). The blade positions at $\psi = 44^\circ$ and 135° are included. As can be seen, the elastic deflections of the blades due to HHC are small when compared to the vortex positions variations at that azimuth. Each symbol indicates a PIV measurement location. The vortices are generated on the left side of the figures. The BL case creates a weak vortex, the MN a strong vortex, both of conventional sense of rotation. The MV case creates a counter rotating vortex at the tip, due to a download at this position. This results in an upwash which modifies the flight path of the vortex relative to the BL case. On the other hand, the MN case has a larger local lift than the BL case, thus creating more downwash here. This moves the vortex below the vortex flight path of the BL case. At typical BVI locations, this leads to increased blade-vortex miss-distance and less noise.

5. PRELIMINARY CONCLUSIONS

The challenges of addressing helicopter deficiencies such as noise, vibrations, power required etc. have been discussed. One way to alleviate them is active rotor control. It can be implemented as HHC or IBC. IBC concepts and results gathered with IBC will be summarised in a second paper [42]. HHC has demonstrated its capability to successfully reduce noise and vibrations, however often not simultaneously or at least not simultaneously in a sufficient manner. In addition, the reduction of power required and stall delay require $2/rev$ control, which can not be controlled by HHC for rotors with more than three blades. For rotors with three or less blades, $2/rev$ can be controlled with HHC, however, this frequency would also be required to reduce vibrations and hence would not be available at the same time to reduce BVI noise or power required or vice versa. In addition, small helicopters with rotors of three or less blades will not be the primarily target group for active rotor control, since especially the cost issue for such helicopters is more severe than for larger helicopters with significantly higher purchase prices and higher empty weight. An active rotor control system, it does not matter whether HHC or IBC, will rise costs and probably empty weight if no sufficient cost and weight savings can be gained through reduced vibration levels (i.e. omission of passive absorbers and extended maintenance intervals for example) and reduced power required and hence reduced fuel consumption in forward flight.

The problem with $2/rev$ control and the problem associated with simultaneous noise and vibration reduction are a severe drawback. This has led the research team in [36] and others to finally conclude, that IBC is highly desirable. Therefore, the focus on active rotor control was shifted towards IBC, although HHC has advantageous in terms of system simplicity. IBC research shall be summarized in a second paper [42].

REFERENCES

AHS = American Helicopter Society
 ARC = Aeronautical Research Council
 ERF = European Rotorcraft Forum

- [1] Reichert, G.: *Helicopter Vibration Control – A Survey*, Vertica, Vol. 5, No. 1, pp. 1 - 20, 1981.
- [2] Loewy, R.G.: *Helicopter Vibrations: A Technological Perspective*, Journal of the AHS, Vol. 29, No. 4, pp. 4 - 30, 1984.
- [3] Braun, D.: *Development of Antiresonance Force Isolators for Helicopter Vibration Reduction*, Journal of the AHS, Vol. 27, No. 4, pp. 37 - 44, 1982.
- [4] Konstanzer, P., Enenkl, B., Aubourg, P.-A., Cranga, P.: *Recent Advances in Eurocopter's Passive and Active Vibration Control*, 64th Annual Forum of the AHS, Montreal, Canada, April 29-May 1, 2008
- [5] Harris, C.M., Crede, C.E.: *Shock and Vibration Handbook*, McGraw Hill, New York, 1960.
- [6] N.N.: *DIRECTIVE 2002/44/EC OF THE EUROPEAN PARLIAMENT AND OF THE COUNCIL of 25 June 2002 on the minimum health and safety requirements regarding the exposure of workers to the risks arising from physical agents (vibration)*, Brussels, Belgium, 25. June 2002.
- [7] Veca, A.C.: *Vibration Effects on Helicopter reliability and Maintainability*, UAAMRDL TR 73-11, 1973.
- [8] Leverton, J.W., Pike, A.C.: *Helicopter Noise – What is Important from a Community Prospective*, 63rd Annual Forum of the AHS, Virginia Beach, VA, 2007.
- [9] Prieur, J., Spletstoesser, W.R.: *ERATO: an ONERA-DLR Cooperative Programme on Aeroacoustic Rotor Optimisation*, 25th ERF, Rome, Italy, September 14-16, 1999.
- [10] Leishman, J.G.: *Principles of Helicopter Aerodynamics*, 2nd Edition, Cambridge University Press, New York, 2006.
- [11] ICAO: *Annex 16 to the Convention on International Civil Aviation – Environmental Protection, Volume I – Aircraft Noise*, 2008.
- [12] Steward, W.: *Second Harmonic Control on the Helicopter Rotor*, ARC Reports and Memoranda, Nr. 2997, 1952.
- [13] Payne, P.R.: *Higher Harmonic Rotor Control: The Possibilities of Third and Higher Harmonic Feathering for Delaying the Stall Limit in Helicopters*, Aircraft Engineering, Vol. 30, No. 8, pp. 222 – 226, 1958.
- [14] Arcidiacono, P.J.: *Theoretical Performance of Helicopters Having Second and Higher Harmonic Feathering Control*, Journal of the AHS, Vol. 6, No. 8, pp. 8 - 19, 1961.
- [15] Wernicke, R.K., Drees, J.M.: *Second Harmonic Control*, 19th Annual Forum of the AHS, Washington D.C., May 1-3, 1963.
- [16] Sissingh, G.J., Donham, R.E.: *Hingeless Rotor Theory and Experiment on Vibration Reduction by Periodic Variation of Conventional Controls*, AHS/NASA Specialist Meeting on Rotorcraft Dynamics, Moffett Field, CA, February 13-15, 1974.
- [17] Wood, E.R., Powers, R.W.: *Practical Design Considerations for a Flightworthy Higher Harmonic Control System*, 36th Annual Forum of the AHS, Washington, D.C., May 13 - 15, 1980.

- [18] Wood, E.R., Powers, R.W., Hammond, C.E.: *On Methods for Application of Higher Harmonic Control*, 4th ERF, Stresa, Italy, September 13-15, 1978.
- [19] Hammond, C.E.: *Wind Tunnel Results Showing Rotor Vibratory Loads Reduction Using Higher Harmonic Blade Pitch*, Journal of the AHS, Vol. 28, No. 1, pp. 10 - 15, 1983.
- [20] Molusis, J.A., Hammond, C.E., Cline, J.H.: *A unified Approach to the Optimal Design of Adaptive and Gain Scheduled Controllers to Achieve Minimum Helicopter Rotor Vibration*, 37th Annual Forum of the AHS, New Orleans, LA, May 17 - 20, 1981.
- [21] Wood, E.R., Powers, R.W., Cline, J.H., Hammond, C.E.: *On Developing and Flight Testing a Higher Harmonic Control System*, Journal of the AHS, Vol. 30, No. 1, pp. 3 - 20, 1985.
- [22] Yen, J.G.: *Higher Harmonic Control for Helicopters with Two-Bladed and Four-Bladed Rotors*, Journal of Aircraft, Vol. 18, No. 12, pp. 1064 - 1069, 1981.
- [23] Shaw, J., Albion, N.: *Active Control of the Helicopter Rotor for Vibration Reduction*, Journal of the AHS, Vol. 26, No. 3, pp. 32 - 39, 1981.
- [24] Shaw, J., Albion, N., Hanker Jr., E.J., Teal, R.S.: *Higher Harmonic Control: Wind Tunnel Demonstration of Fully Effective Vibration Hub Force Suppression*, Journal of the AHS, Vol. 34, No. 1, pp. 14 - 25, 1989.
- [25] O'Leary, J., Miao, W.: *Design of Higher Harmonic Control for the ABC*, Journal of the AHS, Vol. 27, No. 1, pp. 52 - 57, 1982.
- [26] du Val, R.W., Gregory Jr., C.Z., Gupta, N.K.: *Design and Evaluation of a State-Feedback Vibration Controller*, Journal of the AHS, Vol. 29, No. 3, pp. 30 - 37, 1984.
- [27] Lehmann, G.: *The Effect of Higher Harmonic Control (HHC) on a Four-Bladed Hingeless Model Rotor*, Vertica, Vol. 9, No. 3, pp. 273 - 284, 1985.
- [28] Kube, R.: *New Aspects of Higher Harmonic Control on a Four-Bladed Hingeless Model Rotor*, Journal of the AHS, Vol. 37, No. 3, pp. 61 - 68, 1992.
- [29] Spletstoesser, W.R., Lehmann, G., van der Wall, B.G.: *Initial Results of a Model Rotor Higher Harmonic Control (HHC) Wind Tunnel Experiment on BVI Impulsive Noise Reduction*, 15th ERF, Amsterdam, The Netherlands, September 12-15, 1989.
- [30] Achache, M., Polychroniadis, M.: *Development of an Experimental Systems for Active Control of Vibrations on Helicopters - Development Methodology for an Airborne System*, Vertica, Vol. 11, No. 1/2, pp. 123 - 138, 1987.
- [31] Polychroniadis, M.: *Generalized Higher Harmonic Control Ten Years of Aerospace Experience*, Vertica, Vol. 11, No. 1/2, pp. III.7.2.1 - III.7.2.9, 1987.
- [32] Miao, W., Kottapalli, S.B.R., Freye, H.M.: *Flight Demonstration of Higher Harmonic Control (HHC) on S-76*, 42nd Annual Forum of the AHS, Washington, DC, June 2-4, 1986.
- [33] Nygen, K.P., Schrage, D.P.: *Fixed-Gain Versus Adaptive Higher Harmonic Control Simulation*, Journal of the AHS, Vol. 34, No. 3, pp. 51 - 58, 1989.
- [34] Nguyen, K., Chopra, I.: *Application of Higher Harmonic Control to Rotors Operating at High Speed and Thrust*, Journal of the AHS, Vol. 35, No. 3, pp. 78 - 89, 1990.
- [35] Brooks, T.F., Booth Jr., E.R.: *The Effects of Higher Harmonic Control on Blade-Vortex Interaction Noise and Vibration*, Journal of the AHS, Vol. 38, No. 3, pp. 45 - 55, 1993.
- [36] Spletstoesser, W.R., Schultz, K.-J., Kube, R., Brooks, T.F., Booth Jr., E.R., Niesl, G., Streby, O.: *A Higher Harmonic Control Test in the DNW to Reduce Impulsive BVI Noise*, Journal of the AHS, Vol. 39, No. 4, pp. 3 - 13, 1994.
- [37] Murashige, A., Kobiki, N., Tsuchihashi, A., Nakamura, H., Inagaki, K., Yamakawa, E.: *ATIC Aeroacoustic Model Rotor Test at DNW*, 24th ERF, Marseille, France, September 15-17, 1998.
- [38] Murashige, A., Kobiki, N., Tsuchihashi, A., Inagaki, K., Tsujiuchi, T., Hasegawa, Y., Nakamura, H., Yamamoto, Y., Yamakawa, E.: *Second ATIC Aeroacoustic Model Rotor Test at DNW*, 26th European Rotorcraft Forum, The Hague, Netherlands, September 26-29, 2000.
- [39] Spletstoesser, W.R., Kube, R., Seelhorst, U., Wagner, W., Boutier, A., Micheli, F., Mercker, E., Pengel, K.: *Higher Harmonic Control Aeroacoustic Test (HART) - Test Documentation and Representative Results*, DLR Report IB 129-95/28, 1995.
- [40] Spletstoesser, W.R., Kube, R., Seelhorst, U., Wagner, W., Boutier, A., Micheli, F., Mercker, E., Pengel, K.: *Key Results from a Higher Harmonic Control Aeroacoustic Rotor Test (HART) in the German-Dutch Wind Tunnel*, 21st ERF, Saint Petersburg, Russia, August 30-September 1, 1989.
- [41] van der Wall, B.G., Burley, C.L., Yu, Y.H., Richard, H., Pengel, K., Beaumier, P.: *The HART II Test-Measurement of Helicopter Rotor Wakes*, Aerospace Science and Technology, Vol. 8, No. 4, pp. 273-284, 2004.
- [42] Kessler, C.: *Active Rotor Control for Helicopters: Individual Blade Control and Swashplateless Rotor Designs*, 36th ERF, Paris, France, September 7-9, 2010.