



MMI SIMULATION FOR TIGER- HAP

by

Jacques BRUNAND
EUROCOPTER FRANCE
13725 MARIGNANE CEDEX
FRANCE

IPA Christian de VILLEMAGNE
CENTRE D'ESSAIS EN VOL, BASE D'ESSAIS D'ISTRES B.P. 24
13800 ISTRES
FRANCE

TWENTIETH EUROPEAN ROTORCRAFT FORUM
OCTOBER 4 - 7, 1994 AMSTERDAM



MMI SIMULATIONS FOR TIGER HAP

Jacques BRUNAND
EUROCOPTER FRANCE
13725 MARIGNANE CEDEX
FRANCE

IPA Christian de VILLEMAGNE (Ingénieur de Programme TIGRE)
CENTRE D'ESSAIS EN VOL, BASE D'ESSAIS D'ISTRES B.P. 24
13800 ISTRES
FRANCE

1 - SUMMARY

The current three versions of the TIGER combat helicopter program feature a new generation weapon system now close to the end of its development.

The TIGER MMI definition process illustrated in this paper for the HAP version enables optimised use of the aircraft's integrated weapon system.

High function integration (only accessible to this new generation of helicopters) provides the TIGER with a largely higher operational efficiency than the existing attack helicopters of more conventional design.

The methodology implemented in the Crew/System interface, MMI ("Man Machine Interface") consists in a set of iterations, so-called MMI loops, which enable a gradual validation of four definition status:

- status 0 = paper work definition,
- status 1 = validation in piloted simulation,
- status 2 = validation of individual functions in flight tests,
- status 3 = series-production definition after global evaluation of the weapon system during flight tests).

The development and validation of the MMI functions in the scope of the TIGER HAP programme are conducted on three simulators whose specific roles are complementary to each other:

- SIMCO, located in EUROCOPTER DEUTSCHLAND is dedicated to the elaboration of the MMI functions of the "Basic Avionics System" of the 3 TIGER versions.
- The Government Furnished Facility (GFF) CELAR simulator, located in Bruz (near Rennes) is dedicated to the elaboration of the 3 HAP weapons firing controls (Gun, MISTRAL Air-To-Air-Missile, Rockets).
- The Global HAP Weapon System MMI Functions evaluations are realised on the Government Furnished Facility C.E.V. simulator in Istres.

The architecture, characteristics and performances of these 3 simulators are defined to fulfill their initial goal: the definition of the helicopter MMI functions. For an adequate level of representativity, a large field of view outside world image generation, combined with the restitution of cabin noise and vibration were selected.

These simulators, used in the frame of the TIGER MMI development methodology, make it possible to perform iterative MMI definition loops, for a progressive definition of the Weapon System, involving the participation of the Industry, Government Authorities and Operational Crews. This process has shown that:

- it is cost-saving, because it limits the number of Weapon System and equipment softwares versions to 3, since the definition is evaluated at each achievement status step.
- it provides a Weapon System definition fully adapted to the customers and users requirements, since they are involved in the definition



2 - INTRODUCTION TO THE TIGER HAP WEAPON SYSTEM

2-1 Operational requirements

The TIGER-HAP meets the following operational requirements:

Day and night combat

- air-to-air gun firing
- air-to-ground gun firing
- air-to-air missile firing
- air-to-ground rocket firing

Reference mission

The reference mission time is 160 min., distributed into 4 phases:

- Take-off 3 min.
- Transit flight 40 min.
- Attack 87 min.
- Return flight 30 min.

Two thirds of the missions are performed in daylight conditions, one third by night.

2-2 Mission configurations

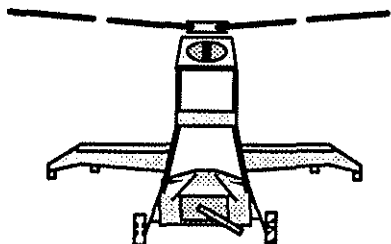

P-A					
P-R1					
P-R2					
P-R3					
P-F					

The normal initial configurations for the HAP are distributed symmetrically. A

typical mission is conducted with a missile launcher pod at each external weapon station, a 22-rocket launcher pod at each internal weapon station and 150 gun shells.

However, the aircraft is also designed for the following configurations:

- The absence of one or more missile launcher or rocket launcher pods, from the above configuration.
- The presence of a missile launcher pod on an external load point and a 12-rocket launcher pod on the other external point.
- A capacity of 450 gun shells.

The HAP weapon system comprises the following equipment:

Weapons:

- Gun subsystem.
- Missile subsystem.
- Rocket subsystem

Sight unit:

- Roof Mounted Sight
- HUD (Head-Up Display)
- HMSs (Helmet-Mounted Sights)

Control and displays

- Armament Control Panel
- Pilot's Armament Strip
- Gunner's Armament Grips
- Piloting grips
- Control and Display units (CDUs).
- Multi-Function Displays (MFDs)

2-3 Functional chains in the Tiger HAP Weapon System

The TIGER - HAP modes and controls are designed to meet the operational requirements, expressed in terms of functional chains.

CEV 333



The MMI simulations on TIGER HAP are involved in the definition and development of these functional chains:

- ACM: Aircraft Monitoring
 - AFC: Automatic Flight Control
 - ANAV: Autonomous Navigation
 - IFF: Identification Friend or Foe
 - COM: Communication
 - ECM: Electronic Countermeasures
 - MM: Mission Management
 - NRM: Nuclear Radiation Measurement
 - RNAV: Radio - Navigation
 - OSTM: On Board System Test and Maintenance
 - SMC: System Moding and Control
 - DCM: Display and Control Management
 - MC: Memorization Concept
 - SM: System Monitoring
 - Warning Concept
- and specifically for the mission system:
- TAF: Target acquisition and Firing
 - PA: Piloting Aids

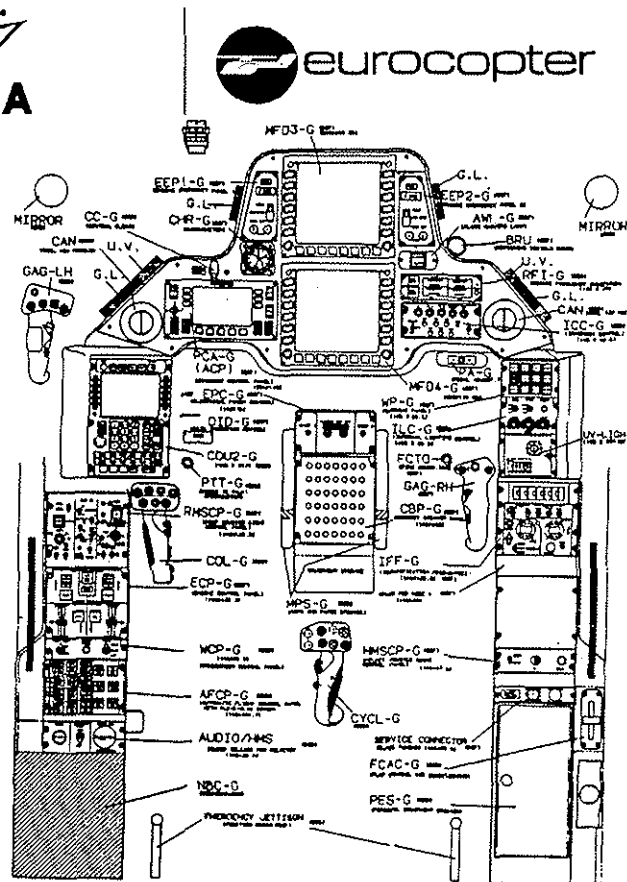

HAP Gunner Cockpit layout

2-4 Weapon system architecture

The HAP weapon system includes a common part to all HAP/HAC/PAH2 weapon systems so-called the "basic system", as well as a "mission-specific" HAP part so-called the "Mission Equipment Package, MEP".

The general basic avionics architecture is defined in such a manner as to minimise interferences between the basic system and the MEP HAP or the EUROMEP (PAH2/HAC) package. Commonality between the basic HAP systems and the PAH2/HAC configurations is therefore achieved.

The basic avionics system is built around a redundant digital bus, 1553B (basic avionics bus).

The MEP HAP configuration is structured around another redundant digital bus, 1553 B (MEP bus).

Data exchanges between the basic system and the MEP package are handled by means of two ACSGs ("Armament Computer/Symbol Generator") which control the dialogue on the mission bus, and both subscribe to the basic avionics bus.

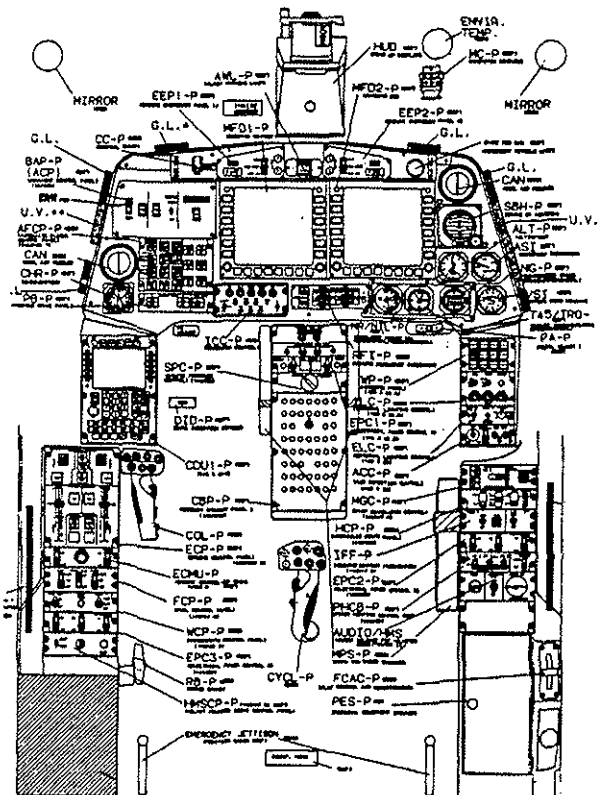

HAP Pilot Cockpit layout

CEV 333

2-5 General Weapon System operation principles

The HAP weapon system modes and controls are based on well-defined general principles listed below.

2-5.1 Pilot's mission

- piloting and flight safety.
- Short range surveillance and self-defence.
- Assistance to Gunner for prepared firing.

2-5.2 Gunner's mission

- Weapon system operation.
- Mission control.
- Tactical responsibility and navigation.

2-5.3 Weapons Operation

The 3 weapon subsystems can be used indifferently by both crew members, subject to the following restrictions:

- Only one weapon subsystem is activated at the same time.
- only the crew member who activated the weapon can fire.
- Rockets cannot be fired from aircraft on ground.

For this purpose and in addition to crew firing safety, a physical firing interlock device is activated on the rocket subsystem when the landing gear is depressed.

2-5.4 Sights operation

Pilot

- The HUD (Head-Up Display) permits head-up piloting and sighting in the area around aircraft centreline.
- The HMS (Helmet-Mounted Sight) permits self-defence firing as well as target designation to the Gunner. It is rather reserved for short-range firing by means of

weapons featuring high de-aiming capacity (gun, missile).

Gunner:

- The Roof Mounted Sight permits accurate long range-firing as well as bad visibility condition firing and laser range-finding.
- The HMS (Helmet-Mounted Sight) permits short range firing and target cueing for the main sight. It is suited for short range firing using weapon featuring high de-aiming capacity (gun, missile).

2-5.4.1 STRIX sight

The Roof Mounted Sight, so-called STRIX sight ("Système de Télémétrie de Reconnaissance et d'Identification tous tempX, all-weather reconnaissance and identification range-finding system) is the helicopter's main sight, only available to the Gunner.

The STRIX sight is an observation, identification and target cueing means, for prepared long-range firing.

It permits accurate range measurement by means of the laser range-finder, and also ensures navigation resetting.

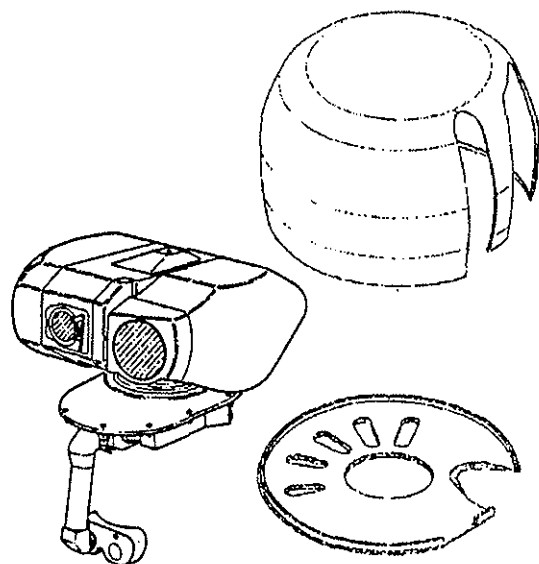



2-5.4.2 HUD (Head-Up Display)

The HUD is only available for the Pilot. It is a head-up piloting means which permits axial or near-axial firing of the three weapon subsystems.

The HUD displays a piloting symbology, together with a sighting/firing symbology which is related to the selected weapon subsystem.

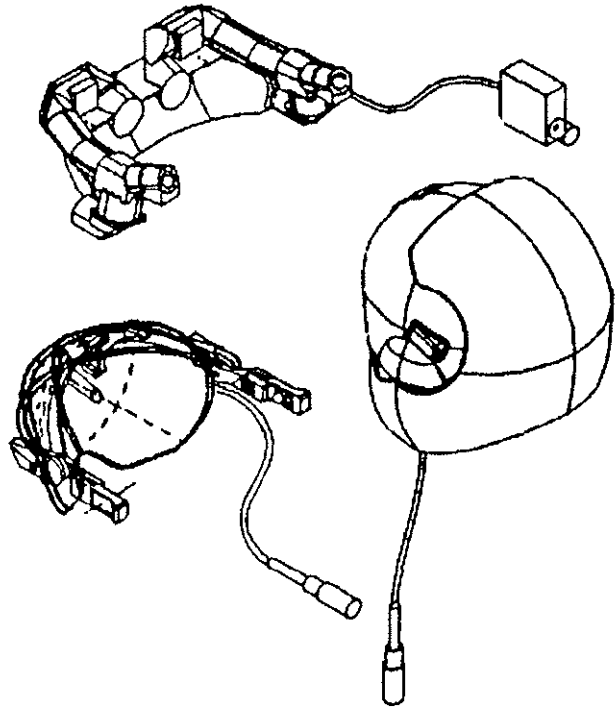
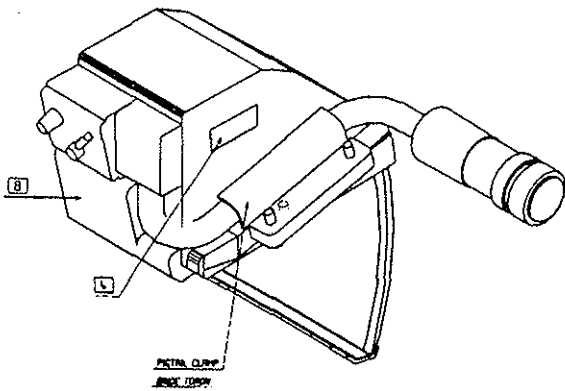

2-5.4.3 HMS (Helmet-Mounted Sight)

The HMS ensures Integrated Night Vision Goggles (NVG) and Light Emitting Diodes (LED) displays and permits sighting for rapid firing or target cueing.

The HMS used on the HAP version is based on a display projection technology on to the visor, for both LED and NVG channels

The night module includes two light intensification devices and one LED module (sighting reticle and 6 discrete LED signs, focused at infinity).

2-5.4.4 Displays

□ Example of Roof-Mounted Sight (RMS) Head-In-Display (HID), in the large field of view Direct View Optics Channel.

Air-to-Air missile engaged, locked-on, firing safety catch not yet raised.

All Air-to-Air missiles are present and available. The laser range finder is in firing mode and the Pilot is in Rocket mode, in observation phase.

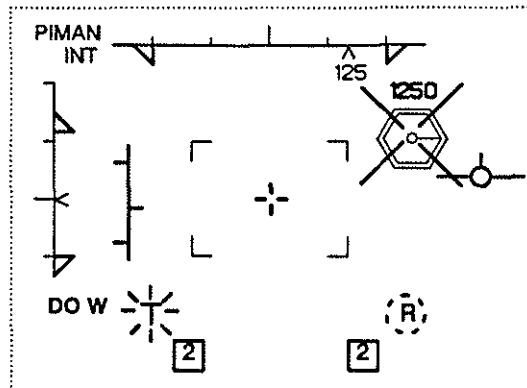

CEV 333



2-6 Control and display components

- Example of Head-Up-Display

Piloting symbology and Rocket subsystem engaged, Internal rocket launcher pod selected and available. Late arm switch not yet raised.

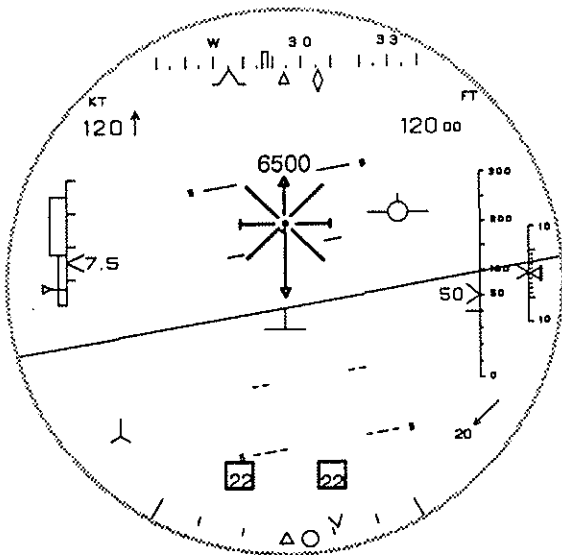

- Displays available in the Helmet-Mounted-Sight:

firing reticle, system state, weapon and alarm diodes.

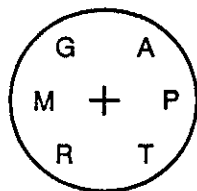

2-6.1 Armament Control Panel

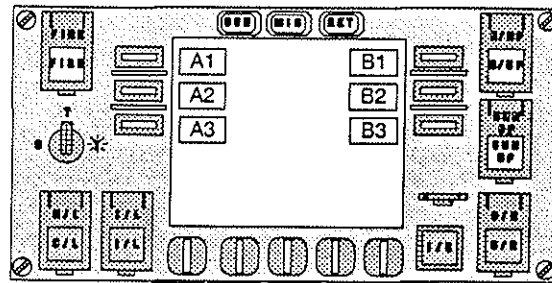

The Armament Control Panel is used by the Gunner for Weapon selection, as well as for changing the selected weapon configuration.

2-6.2 Pilot's Armament Strip

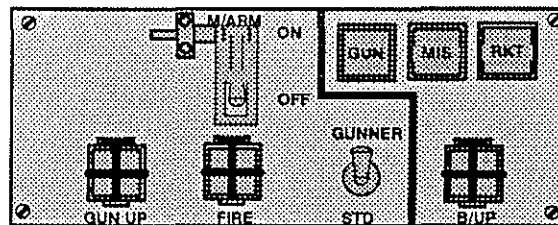

The Pilot's Armament Strip groups part of the weapon system controls at Pilot's reach.

The other weapon system controls are integrated to the flying control grips for "hands-on" operation.

2-6.3 Gunner's Armament Grips

The right hand armament grip is a force-stick, controlling the Roof-Mounted-Sight orientation. Therefore, it only includes controls which do not require simultaneous command of the line-of-sight such as the *sight selection* and *sight slaving* controls.

CEV 333

2-6.4 Piloting sticks

The collective stick comprises a set of conventional controls (ancillaries, trim and autopilot), as well as MEP functions such as the *weapon release and selection controls, the weapon activation and homing head lock-on controls* and the *manual range adjustment controls*.

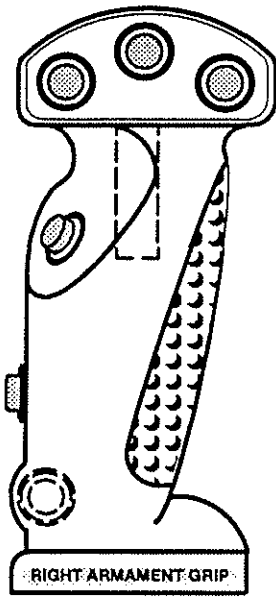

The controls likely to be used for sight aiming are grouped on the left-hand armament grip, which is fixed.

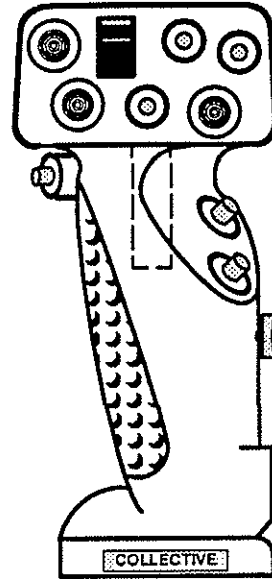

The cyclic stick comprises conventional trim, autopilot and radio controls, as well as Weapon System controls: *sight unit selection, sensor selection, and sighting HUD reticle orientation*.

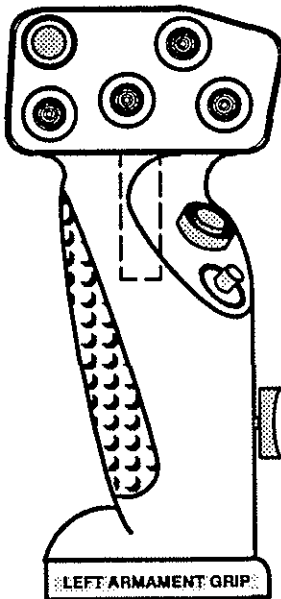

This grip comprises field and channel selection, as well as sight adjustment and range finding controls.

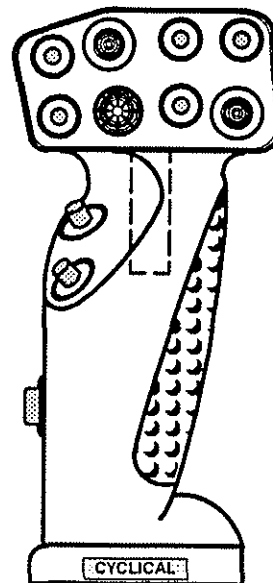

CEV 333



2-6.5 CDUs and MFDs:

□ CDUs: The CDU (one in each cockpit) is the centralised dialogue device to mainly perform:

- initial value setting
- radio-communication control
- radio-navigation control
- autonomous navigation control
- mission management
- route management
- on board system test

Clear and simple editing is provided on the keyboard with Fix Function Keys, Line Select Keys, the "scratchpad" and the "rocker switch" functions

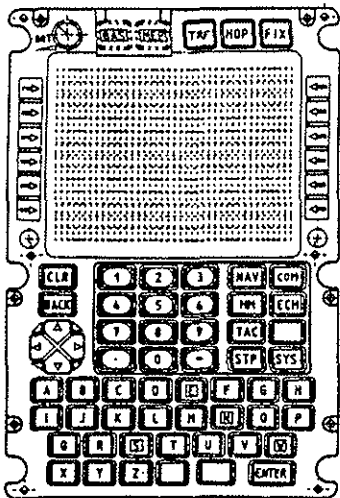

□ MFDs: on both Multi-Function Displays (MFDs) available in each cockpit, a set of pages provides a synthetic, real-time display of: piloting, navigation, aircraft and system state, tactical situation, countermeasures, weapons and visionics.

Example 1: HAP armament page (MFD)

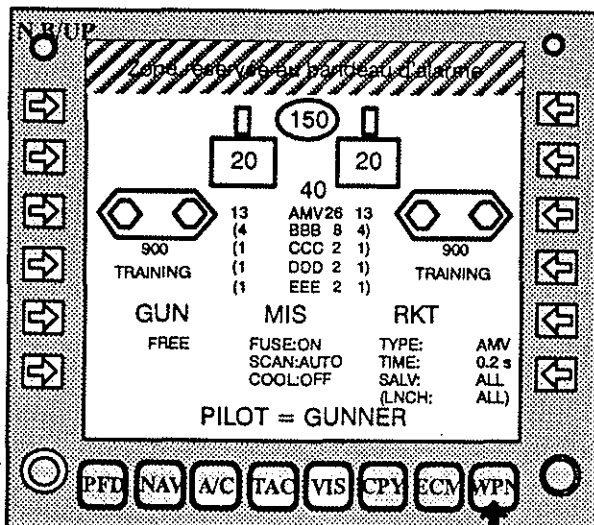

MMI Simulation for TIGER HAP

Example 2: HAP Visionics pages (MFD)

Thanks to the video architecture of the weapon system, the crew can display on MFDs, starting from a visionics menu screen page, an image from the Roof Mounted Sight, comprised of a video display with or without inlaid firing symbology.

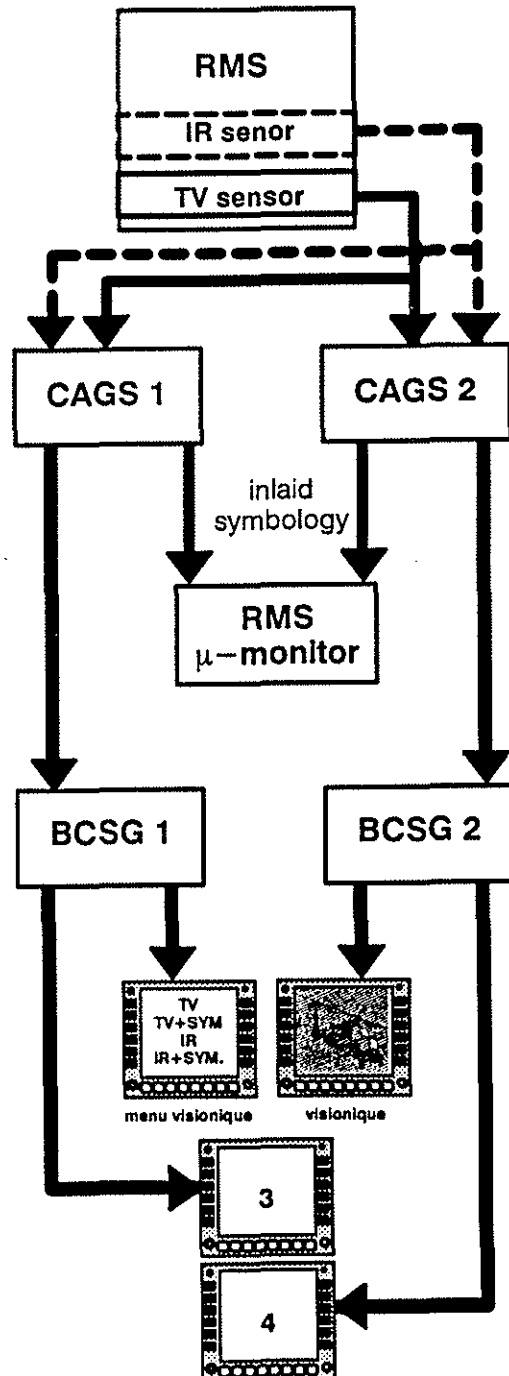

CEV 333



3 - MMI DEVELOPMENT METHODOLOGY

The Tiger MMI definition process falls within the more general scope of the Tiger Weapon System development cycle.

3-1 System definition status

Mission analysis, as well as task distribution to the crew, allowed a set of "functional chains" to be specified, to make up the highest upstream definition of the Weapon System). These "functional chains" form the basis of MMI definition, system and equipment specification drafting.

The final definition of the Tiger Weapon Systems is achieved on completion of an iterative process involving the definition of 4 status:

- Status 0: paper work definition
- Status 1: definition after validation in simulation;
- Status 2: definition after the evaluation of individual functions in flight tests.
- Status 3: series-production definition after global Weapon System evaluation in flight tests.

3-2 MMI definition process

3-2.1 Working groups

A Franco-German working group, so-called "Cockpit Working Group", is entrusted with definition authority on the Tiger's Man-Machine-Interface.

The definition of pure MEP aspects as well as MEP-base interface issues, under the MEP-HAP French contract, devolves on a working group so-called "Groupe Modes et Commandes" (control and moding group)

Both working groups are comprised of representatives from DFHB Franco-German programme management boards, national STPA and BWB boards, EUROCOPTER industrial programme directorates, staffs, STAT and Bückbourg

accessors, official WTD 61 and CEV flight test centres.

The role of both the CWG and "Modes et Commandes" working groups is to make decisions pertaining to the aircraft's MMI definition.

Daily definition and Man-Machine Interface development work is assigned to two other sub-groups of the former: the Consulting Crew (CC), for Franco-German aspects, and the "Equipage Conseil Français, ECF ("French consulting crew") for all MEP-HAP dedicated aspect.

The CC is composed of 2 pilots per country (one from the official test centre and one operational Pilot). The ECF is the French counterpart for the CC.

The CC pilots work in close collaboration with the EUROCOPTER pilots and design offices on all available MMI definition means, and particularly the three programme study simulators detailed in the next section.

3-2.2 MMI Loops

MMI definition is a gradual and iterative process :

It starts from a theoretical definition (status 0) proposed by the industry and it uses the evaluation means placed at its disposal to cause this definition to evolve.

The objective is to meet the aircraft's operational requirements at minimum crew workload penalty.

The elementary crew tasks are defined in the task analysis, resulting from the mission analysis.

This elementary tasks are assessed separately on more and more realistic means (models, test benches, simulators).

Then, they are evaluated after integration within more and more complete



operational scenarios, until full mission simulation.

On each iteration, the assessors may be faced with difficulties when implementing the definition, or even discrepancies in it. Depending on the problem, it can be necessary to change the definition more or less deeply, until a satisfactory definition status is achieved.

4 - PILOTED SIMULATORS (CEV, CELAR, SIMCO)

The development and validation of the MMI functions in the scope of the TIGER HAP programme are conducted on three simulators whose specific roles are complementary to each other:

□ SIMCO, located in EUROCOPTER DEUTSCHLAND is dedicated to the elaboration of the MMI functions of the "Basic Avionics System" of the 3 TIGER versions.

□ The Government Furnished Facility (GFF) CELAR simulator, located in Bruz (near Rennes) is dedicated to the elaboration of the 3 HAP weapons firing controls (Gun, MISTRAL Air-To-Air-Missile, Rockets).

□ The Global HAP Weapon System MMI Functions evaluations are realised on the Government Furnished Facility C.E.V. simulator in Istres.

The architecture, characteristics and performances of these 3 simulators are defined to fulfill their initial goal: the definition of the helicopter MMI functions. For an adequate level of representativity, a large field of view outside world image generation, combined with the restitution of a cabin noise and vibration were selected.

4-1 Roles

4-1.1 CEV

The mission which devolves on the CEV flight test centre in the scope of the TIGER program concerns crew-system interface studies (sights, ACSG mission

computer, cockpits, symbology and procedures) on the HAP version. The subjects involved are:

□ the version-specific systems and equipment items, and more particularly the Pilot-Gunner cooperation issues,

□ the weapon system integration within the basic system, as well as the workload studies (mission-type simulation),

□ assistance to flight tests, facilitated by the geographic proximity between Istres and Marignane.

4-1.2 CELAR

The mission assigned to the armament electronic centre, CELAR ("Centre d'électronique de l'armement"), located at Bruz, next to Rennes in Brittany, involves HAP firing control studies: modelling of the three weapon subsystems and the firing control algorithms, algorithms optimisation with man within the loop, in piloted simulation.

Algorithm definition is insured by EUROCOPTER based upon automation studies and deferred time simulation.

As regards algorithms fine-tuning, the designer also uses records on firing runs carried out on a flying test bench (CEV's PUMA - HELIOS).

Certain human engineering aspects in direct relationship with these subjects are also dealt with at the CELAR.

4-1.3 SIMCO

The SIMCO ("SIMulation COckpit") installed at Ottobrunn on EUROCOPTER DEUTSCHLAND's premises, is intended for development and evaluation of the basic system's MMI functions common to the three TIGER versions, therefore including all functional chains except TAF and PA which are specific to HAP, HAC and PAH2 mission systems.



Completed with EUROMEP's TAF and PA functions, the SIMCO is also the MMI functions study simulator for the anti-armour versions of TIGER.

4.2 Description

Means

According to the simulation center's mission, the implemented means are adapted in order to obtain best possible representativity of the test.

The CEV favours normal and degraded modes of the MEP-HAP configuration as well as the modelling of a significant part of the basic system; to the contrary, firing controls functions are only accounted for in a simplified way.

The CELAR's means are oriented towards high modelling fineness of the firing functions (calculation frequencies of 50 Hz, accurate models of the firing control and armament functions); to the contrary, avionics system representativity is not sought at all costs.

For its part, the SIMCO integrates a high degree of cockpit and basic avionics function representativity, with a significant number of real helicopter equipment (piloting controls channels with linkage and trims, piloting and armament grips, HMS/Ds, Control Panels, RFIs, and Warning System).

Simulation cabins

The CEV and CELAR simulators are each equipped with 2 cabins, ergonomically representative of the MMI functions to be evaluated, and in compliance with the successive definition changes. The Pilot's and Gunner's cabins are separated and each includes its own synthetic outside world imaging system. The pilot's cockpit is equipped with a hydraulic artificial flying control feel system, a sound generation function (sound environment of the helicopter with warnings, weapon noises, etc.) and a vibrating seat.

The SIMCO Cockpit is a 1:1 faithful ergonomic copy of the TIGER's front fuselage between frame 1 and frame 3 and above cockpit floor. The SIMCO is working fully stand alone, as well as in the DASA DOME using an advanced 6 channels external vision system.

Image generation

The CEV and CELAR government centers possess an outside world and sensor image generation system based upon GI10K synthetic image generation concept of the SOGITEC company, providing the crews with:

- 3 adjacent channels representing a field of approximately 200°x55° for the outside world;
- images from various main sight sensors, displayable on the arm-supported eye micro-display and/or on the Multi-Function Displays.

Target and/or escort helicopter generation is also available. This target are included within the image of the landscape and the sensor, for concealment effect, which are significant elements for Nap Of the Earth flight representativity.

For the SIMCO simulator, outside landscape generation is obtained by transferring the SIMCO cockpit and its tests station to the DASA's DOME at Ottobrunn, which consists of a HARRIS NIGHTHAWK computer and a GE COMPUSCENE IV CGI offering a 6 channels projection (about 145°x 120°), one of them being used for sensor generation, if needed (Mast Mounted Sight or Pilot Vision System).

Graphic means

The three TIGER-HAP program simulators run the same VAPS graphic software on a SILICON GRAPHICS workstation. This is also EUROCOPTER's design and definition tool, which facilitates exchanges in the graphic symbology definition process.



The HAP Head-Up Display (HUD) is ensured by a specific computer (CONCEPT 60).

Simulation computers

Almost all model simulation and execution tasks are handled and supported by the central simulation computer:

The TIGER helicopter model, comprised of an aero-mechanical model and an adapted autopilot model (basic and upper AFCS modes), as well as an MTR engine model.

The models for the various onboard equipments including control stations and behavioural models (Roof Mounted Sight, weapon subsystems, countermeasures).

The models for the basic avionics (BCSG) and mission (ACSG) weapon system logic computers.

For performance and resource optimisation, however certain applications are relocated (for example, the Head-Up Display symbol generation function).

Test rooms

This environment is essential to simulation test control and follow-up. It permits dialogue between the crews and test engineers (voice links, cockpit display monitoring, test operator-specific displays for configuration setup, failure generation, etc..

The test manager can therefore control the progress of the scenario and implement tactical aspects (injected failures, target displays) or present the various concept or options to be assessed.

The test room is indispensable for crew briefing/debriefing, as well as for model fine-tuning and validation.

4-3 CONCLUSION

These simulators, used in the frame of the TIGER MMI development

methodology, make it possible to perform iterative MMI definition loops, for a progressive definition of the Weapon System, involving the participation of the Industry, Government Authorities and Operational Crews. This process has shown that:

it is cost-saving, because it limits the number of Weapon System and equipment softwares versions to 3, since the definition is evaluated at each step.

it provides a Weapon System definition fully adapted to the customers and users requirements, since they are involved in the definition

5 - AN EXAMPLE OF MMI OPTIMISATION RESULTS: THE WARNING CONCEPT

5-1 Objectives

The objective of the Warning Concept is to provide the crew, in case of aircraft degradation, with synthetic information allowing the problem to be coped with efficiently, making best possible use of the remaining operational functions.

5-2 Role distribution

SIMCO: simulating the Warning Concept, the basic avionics, and the EUROMEP mission system degraded modes.

CELAR: simulating the weapons firing controls degraded modes, without simulating the Warning Concept.

CEV: simulating the Warning Concept for a minimum number of basic avionics system-related functions, and simulating the MEP-degraded modes exhaustively in order to provide the crew with a representative workload.

Due to time schedule requirements, the evaluation of the Warning Concept involving consequential effects of degradation in the HAP system, as well as the associated MMI aspects, were firstly handled at the CEV, through the study of HAP degraded modes.



In order to perform this work properly, it is vital to obtain representativity of the crew's workload. The scenarios adopted at the CEV therefore integrated Piloting/Navigation phases, and air-to-surface attack missions with frequent injected air threats.

In keeping with the specific features of each test site, it is clear that complementarity allowed significant results to be achieved very early in the process.

The parallel conduct of simulation studies on the various sites resulted in appreciable time-savings in this case.

5-3 Results achieved in the early campaigns

The early campaigns on the MEP-HAP degraded modes and the Warning concept at the CEV were completed with the evaluation of weapons firing control degraded modes at the CELAR. These campaigns highlighted the need for a global approach involving various crew information levels. Anomaly detections should permit best response by implementing, depending on the case:

- immediate crew warning,
- fast access to a list of remedial actions (as soon as possible) in accordance with the context,
- messages and complementary information on system state,
- automatic reconfiguration of redundant system.

The crew must be kept informed of the state of operational functions, rather than obtaining information equipment by equipment. In fact, the helicopter's integration level would make inefficient any information pertaining to equipment items viewed separately.

For example, gun firing requires the cooperation of the following items: the weapon subsystem, but also the firing control

computer, the mission computer, the bus controllers, the gyro units, etc..

A failure affecting any single element will impact on gun firing.

5-4 Consequences and current actions

After these MEP-HAP degraded modes evaluations, MMI modifications were introduced, especially:

- Simplified data access procedure, by adding a "DO-LIST" button on the instrument panel. By simply depressing this button, the crew can display an instruction page on MFD (under the form of anomaly identification messages, with the consequences and remedial actions).
- Equipment failure MFD pages replaced by two pages concerning the state of operational functions.
- Improved alarm message management, for messages displayed on a specific strip on the MFD's.

The results obtained in the scope of the MEP study will be validated on SIMCO means, in the framework of degraded mode studies bearing on the basic system and the EUROMEPE.

6 CONCLUSION

The current three versions of the TIGER combat helicopter program feature a new generation weapon system, close to the end of its development.

The TIGER MMI definition process illustrated in this paper for the HAP version enables optimised use of the aircraft's integrated weapon system.

High functional integration (only accessible to this new generation of helicopters) provide the TIGER with largely higher operational efficiency than the existing attack helicopters of more conventional design.



The TIGER HAP development contract involves three simulators whose specific roles are complementary to each other.

These simulators, used in the frame of the TIGER MMI development methodology, make it possible to perform iterative MMI definition loops, for a progressive definition of the Weapon System, involving the participation of the Industry, Government Authorities and Operational Crews. This process has shown that:

- it is cost-saving, because it limits the number of Weapon System and equipment softwares versions to 3, since the definition is evaluated at each step.

- it provides a Weapon System definition fully adapted to the customers and users requirements, since they are involved in the definition

This methodology, and these facilities can be used in the future for the evolution of the current TIGER definition.



Abbreviations

ACSG: Armament Computer Symbol Generator (HAP Mission System Computer)
AFCs: Automatic Flight Control System
ATAM: Air-toAir Missile (Mistral for HAP and HAC)

BCSG: Bus Controller Symbol Generator (3 Versions Basic Avionics Computer)

CAGS: Calculateur d'Armement Générateur de Symboles (French name for ACSG)
CC: Consulting Crew
CDU: Control and Display Unit
CELAR: Centre d'électronique de l'armement
CEV: Centre d'Essais en Vol
CWG: Cockpit Working Group)

DASA: Deutsche Aerospace
DFHB: Deutsch-Französisches-Hubschrauber-Büro
DOME: DASA Simulation facility.

ECF: Equipage Conseil Français (French part of CC)
EUROMEP: PAH2/HAC Mission System

FFK: Fix Function Key (for CDUs and MFDs)

GFF: Government Furnished Facility

HAC: Hélicoptère AntiChar
HAP: Hélicoptère d'Appui Protection
HID: Head In Display (Roof Mounted Sight display)
HMS: Helmet Mounted Sight (for HAP only)
HMS/D: Helmet Mounted Sight/Display (for HAC and PAH2 only)

LSK: Line Select Key (for CDUs and MFDs)

MEP: Mission Equipment Package (HAP Mission System)
MMI: Man-Machine-Interface
MTR: MTU/TURBOMECA/ROLLS-ROYCE

MFD: Multi-Function-Display (Tiger Head Down Displays screens)
MMS: Mast Mounted Sight (HAC/PAH2 main sight)

NVG: Night Vision Goggles
PAH2: Panzer Abwehr Hubschrauber-2 Generation

RMS: Roof Mounted Sight (HAP main sight)

SIMCO: EUROCOPTER DEUTSCHLAND Simulation Cockpit
STAT: Section Technique de l'Armée de Terre (in Valence-France)

WTD: Wehr Technische Dienststelle Für Luftfahrzeuge