

# **ELEVENTH EUROPEAN ROTORCRAFT FORUM**

Paper No. 9

## **SOUND INTENSITY MEASUREMENTS INSIDE AIRCRAFT**

S. Gade  
T.G. Nielsen

Brüel & Kjær, 18 Nærum Hovedgade,  
2850 Nærum, Denmark

September 10-13, 1985  
London, England

THE CITY UNIVERSITY, LONDON, EC1V 0HB, ENGLAND

## ABSTRACT

Intensity measurements inside motor vehicles, aircraft, etc. are normally very difficult to perform due to the fact that the sound field in such enclosures are highly reactive. Very careful choice of microphone spacing may be required, and very long averaging times may be necessary.

In this paper, it is shown how reliable measurements were performed in a SAAB-FAIRCHILD 340 propeller aircraft. The left side of the aircraft was mapped using both intensity and pressure measurements. The global and local reactivity indices were determined and compared to the dynamic capability of the measuring system for the first, second and third harmonic of the propeller frequency, 80 Hz.

## INTRODUCTION

In this paper some results from sound intensity and sound pressure measurements performed inside an aircraft are shown. The aim of the measurements was to locate the sound paths from engine to cabin by mapping the sound intensity and sound pressure distribution from various interior surfaces for the first three harmonics of the propeller frequency inside a "green" aircraft, and to establish the validity of the intensity measurements.

## INSTRUMENTATION

The sound intensity measurements were performed with the Brüel&Kjær Sound Intensity Analyzing System Type 3360. The spectra were stored on a Digital Cassette Recorder Type 7400 and all postprocessing was carried out using the Graphics Recorder Type 2313 equipped with the application Package Type BZ 7004. The microphones were arranged in a face to face-solid spacer configuration using the 1/2" microphone pair Type 4177, with a 50 mm microphone separation.

The instruments were powered from 2 car batteries (12 volts 60 ampere-hours) via a sine wave Inverter Type EA-MEC 502/12 500/700 VA with an efficiency of 75%, which ensured power for 2 1/2 hours of measurements. Extra batteries were available.

## MEASUREMENT CONDITIONS

The measurements were performed in Sweden with the collaboration of SAAB-SCANIA Aircraft Division on a Saab-Fairchild SF 340.008 Aircraft. The operating conditions were 15 kft cruising altitude, 260 knots air speed and 1250 propeller rpm (4 propellers).

## MEASUREMENT SURFACES

70 measurement surfaces on the left hand side panel were defined as shown in Fig.1 and Fig.2. The average size of each measurement surface is 0,42 m<sup>2</sup> (65 cm × 65 cm) and the distance between the panel and the microphone probe was approximately 20 cm. This distance was found to provide a good compromise between spatial resolution and measurement accuracy.

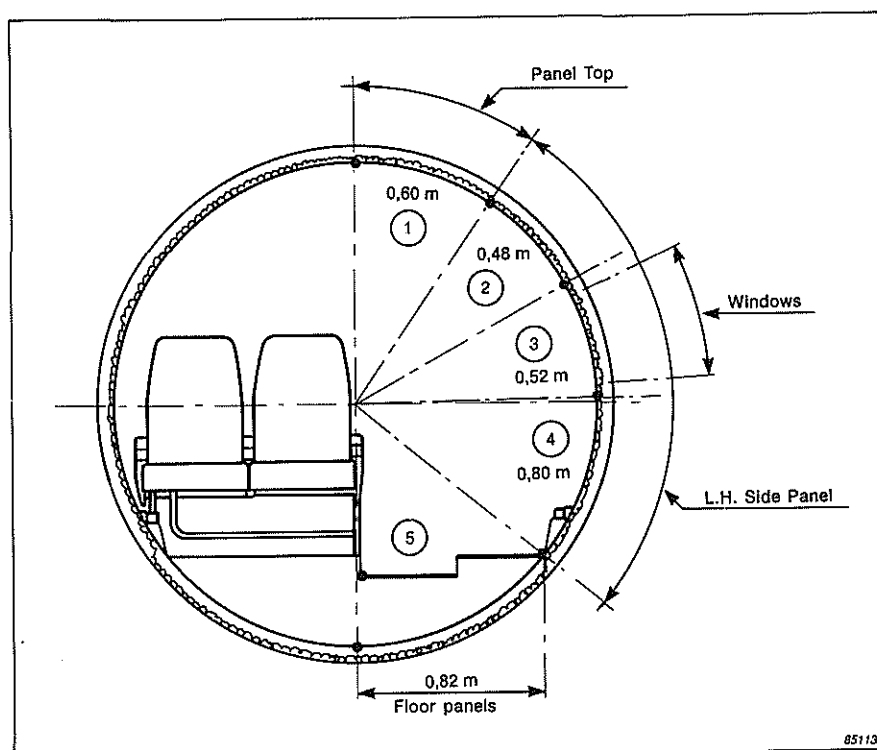

Fig.1. Cross section of the aircraft showing the measurements surfaces

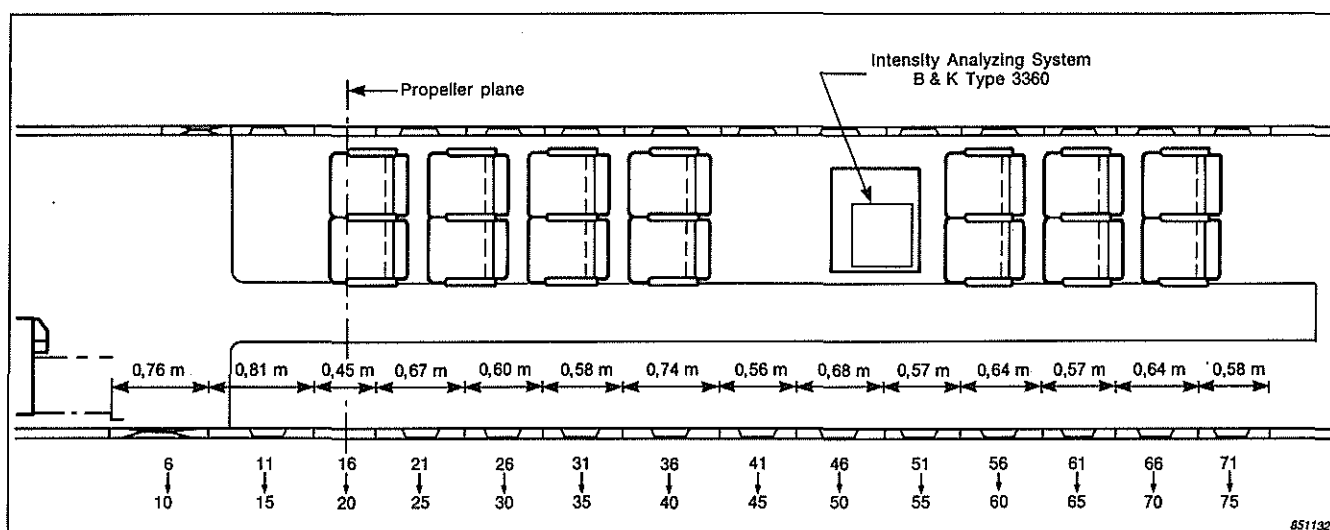

Fig.2. Top view of the aircraft showing the measurement surfaces

## MEASUREMENT TECHNIQUE

The individual intensity measurements were carried out using a spatial-averaging technique. The probe was scanned uniformly over the individual surfaces – as if “painting” the surfaces – during the averaging time. A linear averaging time of 64 seconds was used for the intensity and 32 seconds for the pressure measurements.

## DYNAMIC CAPABILITY

The phasematching between the measuring channels of a sound intensity analyzer is known to be of crucial importance since the intensity is proportional to the phase difference between the 2 microphone positions in the sound field. A phasemismatch between channels will thus introduce an apparent or residual intensity which may bias the measurement results.

The Residual Intensity Index  $L_{K,0}$  is a measure of the bias error that may be present in a given measurement.  $L_{K,0}$  is the difference between the measured residual intensity level and the pressure level when a zero intensity broadband signal is fed to the two measuring channels. The procedure is described in Refs. [1], [2], [3]. Fig.3. shows that the Reactivity Index of the sound field  $L_K$ , i.e. the difference between the intensity and pressure levels in an actual measurement, should numerically be 7 dB smaller than the Residual Intensity Index  $L_{K,0}$  to ensure a bias error due to phasemismatch smaller than  $\pm 1$  dB.

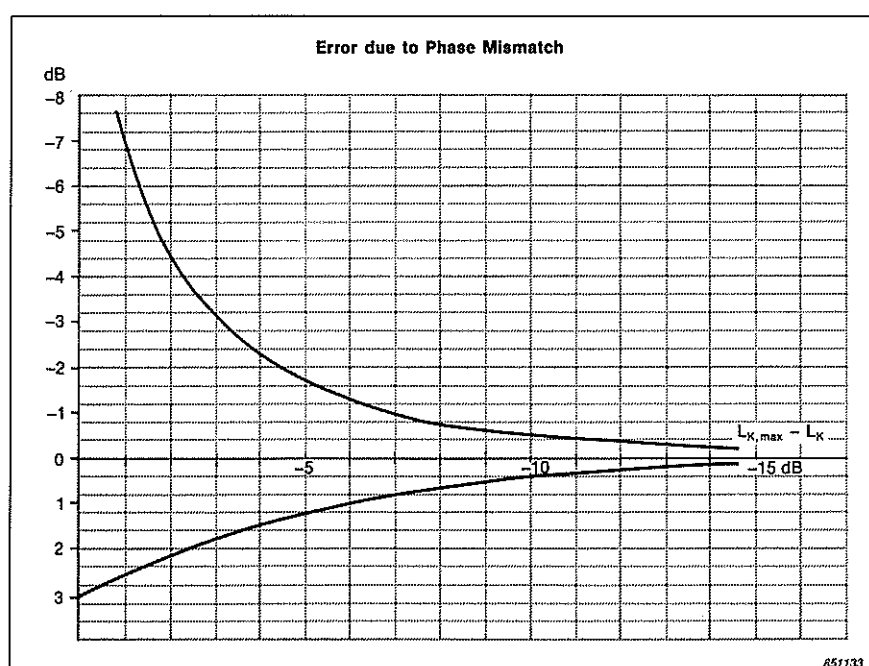

Fig.3. Error due to phasemismatch for intensity measurements

$L_{K,0} + 7$  dB is called the Dynamic Capability of the system. The results are summarized in Table 1.

Channel	$L_{K,0}$ $\Delta r = 12$ mm	Dynamic Capability $\Delta r = 12$ mm	$L_{K,0}$ $\Delta r = 50$ mm	Dynamic Capability $\Delta r = 50$ mm
80 Hz	-15,5 dB	-8,5 dB	-21,5 dB	-14,5 dB
160 Hz	-24,1 dB	-17,1 dB	-30,1 dB	-23,1 dB
280 Hz	-20,5 dB	-13,5 dB	-26,5 dB	-19,5 dB

Table 1. Residual Intensity Index  $L_{K,0}$  and Dynamic Capability for the system using 12mm and 50mm spacers

An example: For a 50mm spacer it is seen from Table 1 that the Dynamic Capability is -14,5dB at 80Hz. If an intensity measurement shows a level which is less than 14,5dB below the measured pressure level the error due to phasemismatch is smaller than 1 dB, as indicated in Fig.3.

If the measured intensity level is more than 14,5dB below the measured pressure level the error is larger than 1 dB.

For the 160Hz and 250Hz one third octave bands it is seen that the intensity levels should not be more than 23,1 dB respectively 19,4 dB below the measured pressure levels to ensure an accuracy better than 1 dB.

**RANDOM ERROR**

It is shown in Ref.[2] that random error depends on the BT-product (the product of the bandwidth and the averaging time) and the reactivity index  $L_K$  (the difference between intensity and pressure level) of the measurement. Fig.4 indicates that for high reactivity indices much longer averaging times are needed for intensity measurements, than for the corresponding pressure measurements.

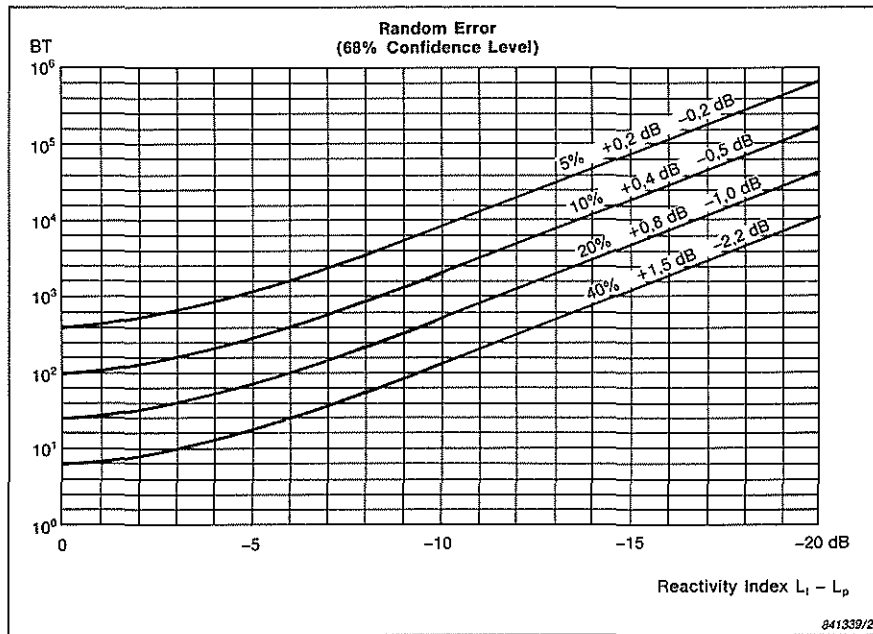

Fig.4. The normalized random error for intensity measurements is a function of BT-product and Reactivity Index,  $L_{K,0}$

**MEASUREMENT RESULTS**

Figs.5 and 6 show the pressure and intensity spectra averaged over the whole left hand side panel, i.e. averaged globally. As expected we find an intensity level much lower than the pressure level, i.e. a low net flow of acoustic energy. The explanation is that since there is a very low amount of absorbing materials inside a "green" aircraft, we have due to the law of conservation of energy, that nearly the same amount of energy that enters the cabin must also leave the cabin again. The global reactivity indices for the 3 frequency bands of interest are summarized in Table 2.

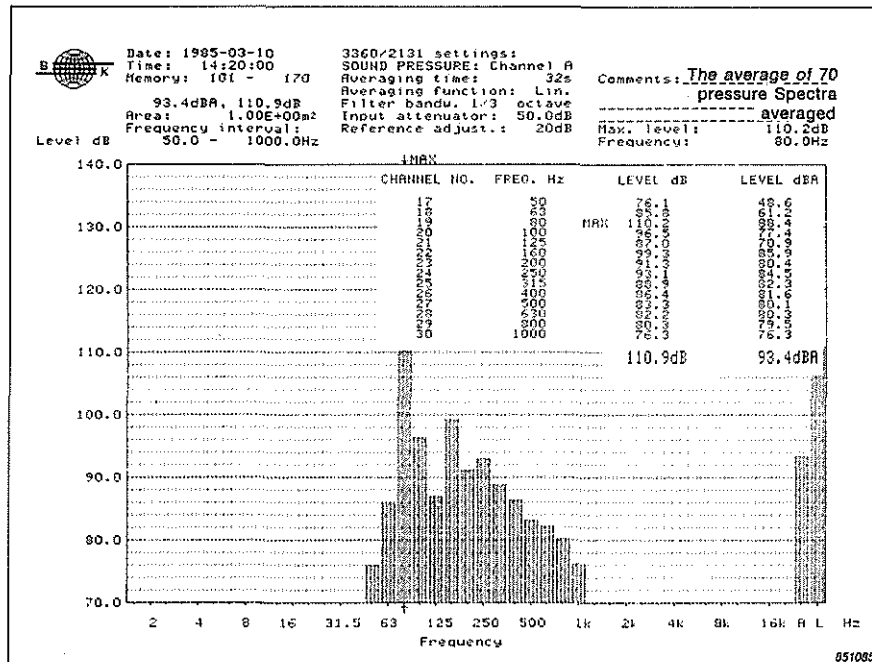

Fig.5. Average Pressure spectrum for the left hand side panel

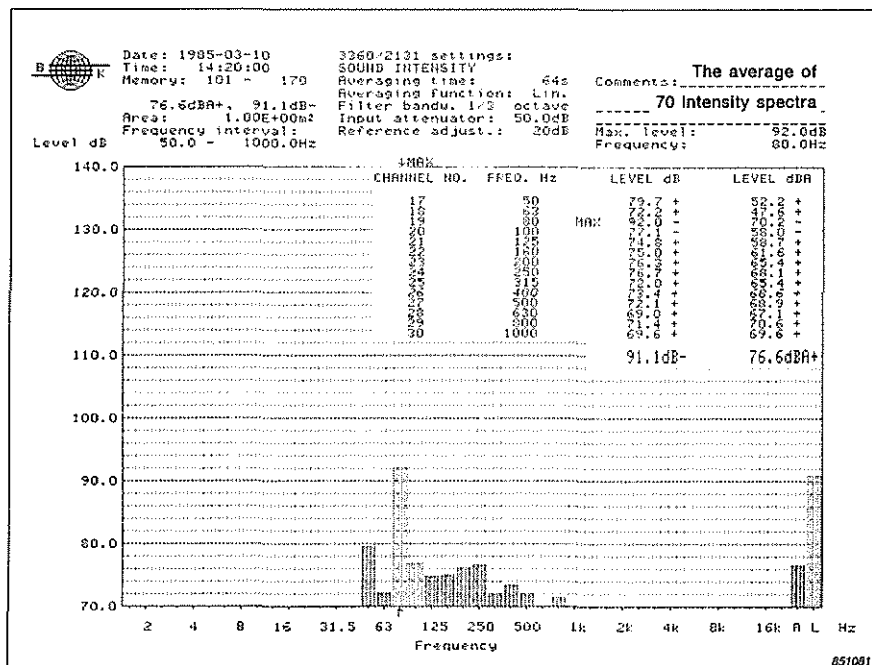

Fig.6. Average Intensity spectrum for the left hand side panel

Frequency	80 Hz	160 Hz	250 Hz
$L_{k,global} = L_{i,g} - L_{p,g}$	-18,2 dB	-24,2 dB	-16,4 dB

T00722GB0

Table 2. The global Reactivity Index for the measurements

If we compare Table 1 and 2 we can see that only the global intensity in the 250Hz band can be estimated within an accuracy better than 1 dB, due to fact that we are dealing with the highly reactive sound field.

On the other hand, the so called "hot" spots, the regions of interest, inside the aircraft are where we have a high amount of energy flow, that is where the intensity level is relatively high. In general where the intensity level is high the reactivity index must be low because the pressure distribution will not show extreme variations over the measurement panel the same way the intensity level will do. Thus the error in estimating the higher intensity levels will be relatively low.

Figs.7 and 8 show the intensity distribution for the 80Hz one third octave band. As an example Fig.8 is shown with equal intensity level contour lines and Fig.7 without contour lines.

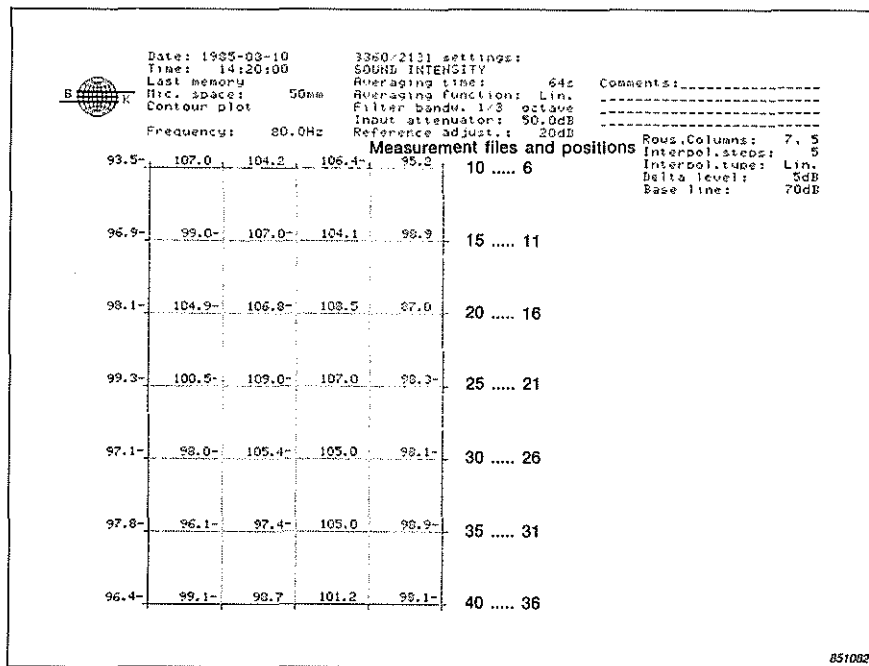

Fig.7. Intensity distribution in the 80Hz frequency band for the front part of the cabin

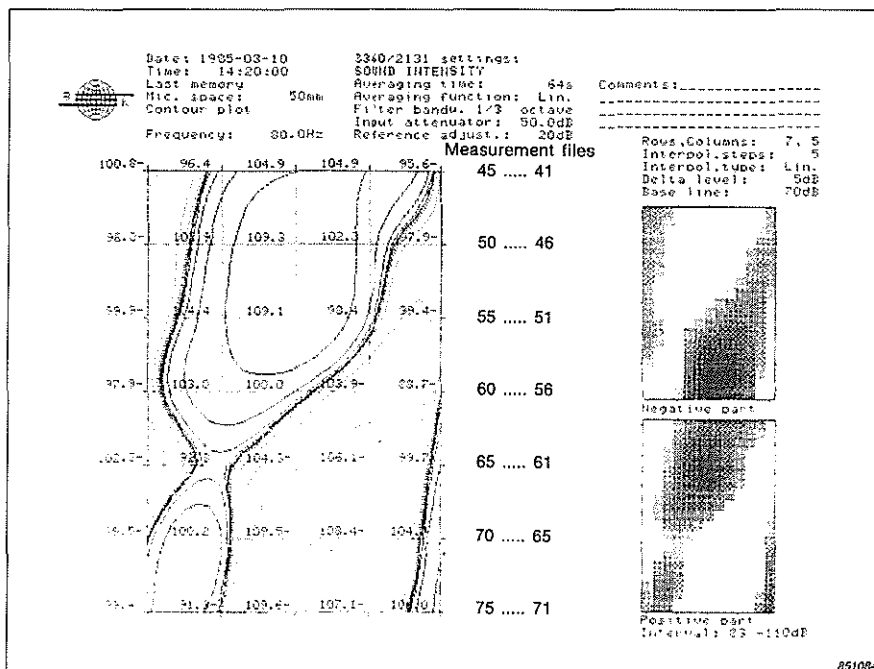

Fig.8. Intensity distribution in the 80Hz frequency band for the rear part of the cabin

To be able to check the validity of each of the individual measurements we need to know the distribution of the reactivity index,  $L_K$ . The distribution of  $-L_K$  is shown in Figs.9 and 10. Here we see that only 2 local measurements show an intensity level that is more than 14,5dB below the pressure level, which means that only these 2 intensity measurements have an error due to phasemismatch larger than 1 dB.

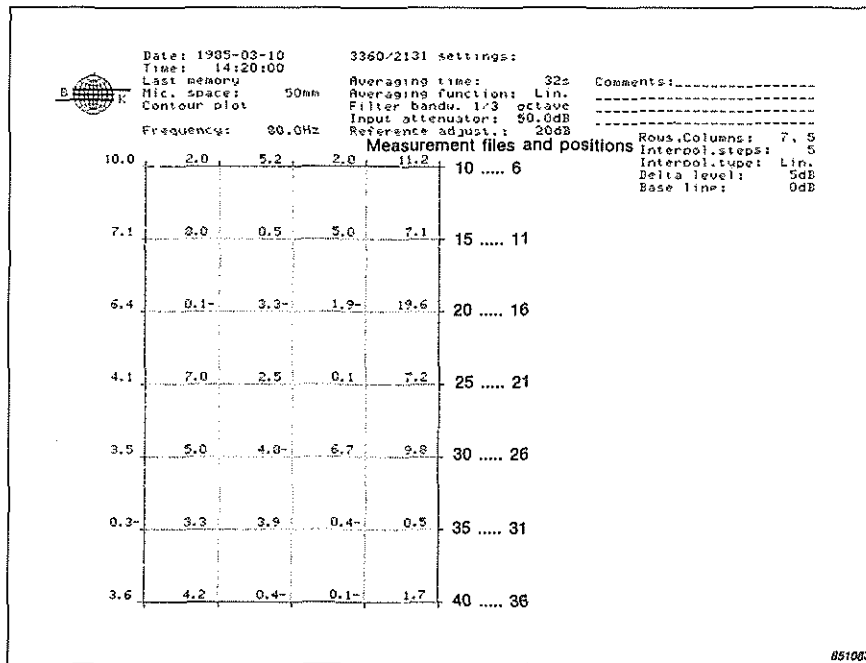

Fig.9. Distribution of the difference between Pressure and Intensity level, i.e.  $-L_K$ , at 80 Hz for the front part of the cabin

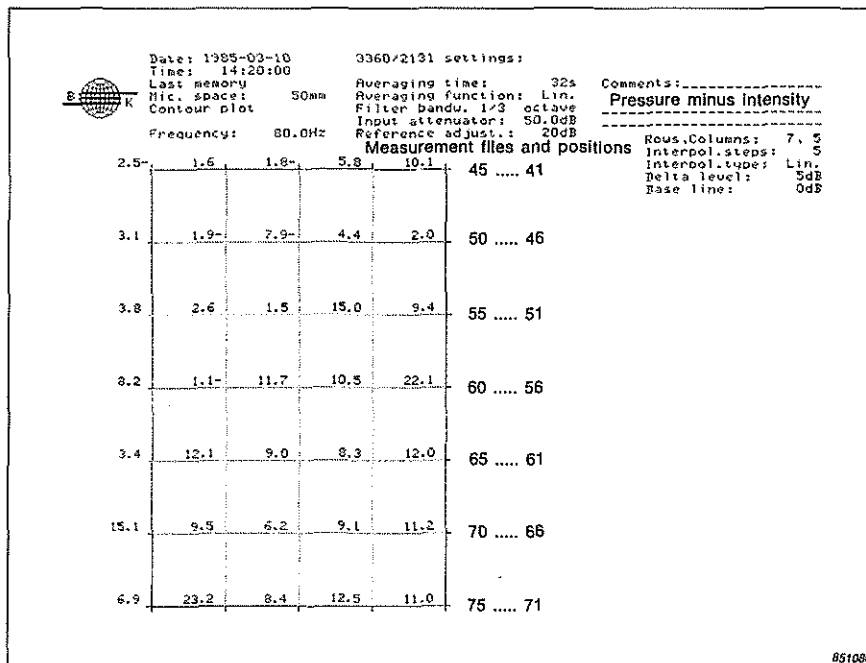

Fig.10. Distribution of the difference between Pressure and Intensity level at 80 Hz for the rear part of the cabin



Under free field conditions the intensity level and the pressure level will be approximately the same. In general sound fields the pressure level is normally higher than the intensity level, i.e.  $L_K < 0$ .

Figs.9 and 10, however, show 10 out of 70 measurement positions where the intensity level is higher than the pressure level. This is due to standing wave phenomena. In a standing wave the intensity is the geometrical mean value between the maximum pressure and minimum pressure. In other words if the standing wave ratio is 20 dB then  $L_K$  can take any value between + 10 dB and -10 dB at the various measurement positions. In a standing wave tube with a standing wave ratio of 25 dB corresponding to an absorption coefficient of 0,2 we would expect to find the intensity level to be higher than the pressure level, i.e.  $L_K > 0$ , in 14% of all measurement positions.

### VALIDITY CHECK

As an example we can calculate the random error and the error due to phasemismatch from measurement position number 75. From Figs.8 and 10 and Table 1 we have  $L_p = 106,3$  dB,  $L_I = 99,4$  dB,  $L_K = -6,9$  dB and  $L_{K,0} = -21,5$  dB.

$L_{K,0} - L_K = -14,6$  dB. From Fig.3 we find that the error due to phasemismatch is approximately 0,1 dB. In this calculation we have not taken the random error into account.

$L_K = -6,9$  dB and  $BT = 80 \text{ Hz} \cdot 64 \text{ sec.} = 5120$ . From Fig.4 we find that the random error is less than 5% or less than  $\pm 0,2$  dB.

### CONCLUSION

It is possible to locate where acoustic energy enters and leaves aircraft cabins using intensity measurements. To establish the validity of such measurements one must always measure the residual intensity index,  $L_{K,0}$  of the measuring system as well as the reactivity index,  $L_K$  of the sound field, as it is measured.

Errors due to phasemismatch depend on the difference  $L_{K,0} - L_K$  and random error depends on  $L_K$  as indicated in Figs.3 and 4.

### REFERENCES

- [1] Gade, S., Ginn, K.B., Roth, O. and Brock, M.: "Sound Power Determination in Highly Reactive Environments using Sound Intensity Measurements", *Proceedings of Internoise 1983*, pp.1047-1050. Expanded version published as *Brüel & Kjær Application Note BO-0074 (1983)*
- [2] Gade, S.: "Validity of Intensity Measurements", *Proceedings of Internoise 1984*, pp.1077-1082
- [3] Gade, S.: "Sound Intensity and Its Application in Noise Control", *Sound and Vibration*, March 85, pp.14-26