

**EIGHTEENTH EUROPEAN ROTORCRAFT FORUM**

**C - 04**

**Paper N° 100**

**DEVELOPMENT OF THE**

**BK 117 C-1**

**WITH ARRIEL 1-E ENGINES**

**W. Bergner, K. Wölfl**

**EUROCOPTER DEUTSCHLAND GMBH**

**GERMANY**

**September 15 - 18, 1992**

**AVIGNON, FRANCE**

**ASSOCIATION AERONAUTIQUE ET ASTRONAUTIQUE DE FRANCE**



# Development of the BK 117 C-1 with Arriel 1-E Engines

Werner Bergner  
Project Manager

Karl Wölfl  
Manager Test Analysis  
Helicopter Systems

Eurocopter Deutschland  
Munich, Germany

## Abstract

The BK117 C-1 with Arriel 1-E engines is the newest member of the BK117-family. The Arriel 1-E engine will be offered as an alternative to the Lycoming LTS 101-750 B-1 engine. With this concept Eurocopter enables the customer to select an engine especially tailored to his requirements.

The engine installation and the certification program were carried out as an international teamwork between Eurocopter Deutschland, Kawasaki Japan and Turbomeca/CGTM France. This paper summarizes the technical main features and milestones of the BK117 C-1 program. Special development and certification test campaigns (e.g. air intake icing tests with a full scale helicopter in the wind tunnel of the "Bundesversuchs- und Forschungsanstalt Arsenal" at Vienna) as well as the performance aspects are presented.

## Introduction

The excellent worldwide reputation of the BK117 is also found on the feature that it can be easily converted in a short time for a wide variety of different missions offering true multipurpose, utility application. In order to keep this very high reputation and to fulfill future requirements on the market EUROCOPTER launched various activities.

The latest steps to follow up this product policy were :

- the increase of the MTOW (maximum take-off weight) from 3200kg to 3350kg without a change of the empty weight
- the alternate engine concept (Lycoming or Turbomeca)

The BK117 C-1 with Arriel 1-E engines is shown in figure 1.

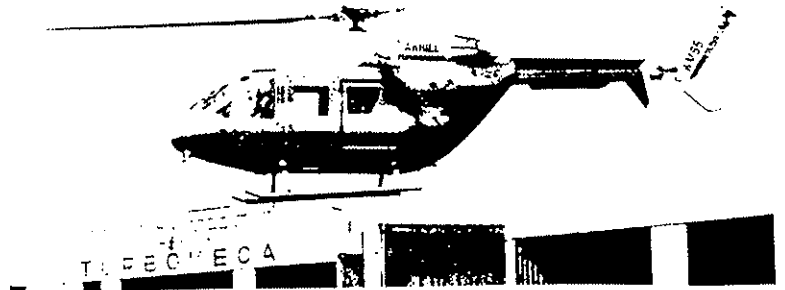

Figure 1: BK117 C-1

## Design Philosophy

The future production concept of the BK117 (figure 2) will be based on the MTOW of 3350kg as a common basis for:

- BK117 B-2 with Lycoming LTS (101-750 B-1) engines and
- BK117 C-1 with Turbomeca (Arriel 1-E) engines

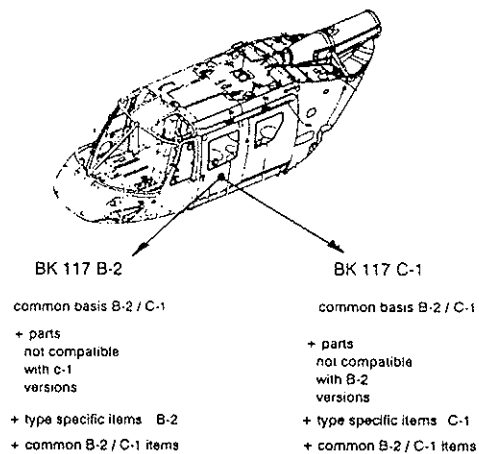

Figure 2: Future Production Concept of the BK117

Type specific items will be added according to the selected engine. This

Presented at the  
18th European Rotorcraft Forum  
15.-18. September, 1992  
Avignon, France

means that there is a maximum commonality for customers using BK117 B-2 and C-1.

The MTOW of 3350kg includes an increase of the center of gravity range and an increase of the main rotor control range.

The Arriel 1-E Engine

The Arriel 1-E engine (figure 3) is a free turbine turboshaft engine for the 650-750 SHP class powerplants.

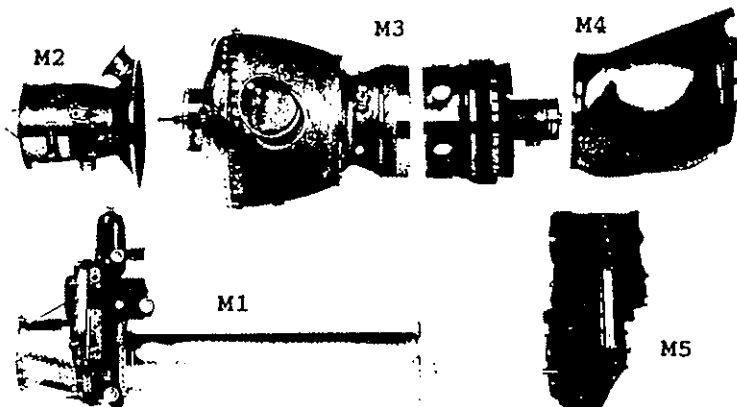
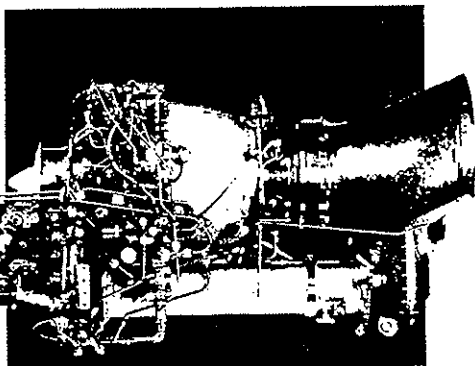

ISA - Sea level - Power ratings in shp					
Arriel model	1 min.	2.5 min	30 min	Takeoff	Max Cont
		OEP*			
1E	-	750	735	708	692

Figure 3: Arriel 1-E Engine

There are five interchangeable modules (modular design concept) the engine consists of:

Module 1: Accessory gear box and drive shaft (power input)  
The accessory gear box is connected via an external tube to the reduction gear box.

Module 2: Axial compressor  
The first compression is

done by the axial compressor. It consists of one axial stage.

Module 3: High pressure assembly  
The high pressure assembly includes

- one radial compressor stage for the main compression
- two stages gas generator turbine with mounted blades
- the combustion chamber with annular direct flow and rotative fuel injection

Module 4: Power turbine  
It consists of

- one stage turbine with mounted blades
- the containment shield
- the overspeed protection sensors

Module 5: Reduction gear box

The reduction gear box is mounted on the rear. It reduces the rotation speed from 41656 rpm to 6000 rpm for the power output.

The overspeed protection (overspeed box) of the power turbine is designed according to the new FAA requirements with respect to HIRF.

Engine Installation

It was the intention of EUROCOPTER to keep the changes of the baseline helicopter caused by the new engine as small as possible. This high target could be met because there is no change of the following systems:

- Main gear box complete (inclusive accessories)
- Main and tail rotor system
- Drive Shafts
- Flight control system
- Fuel system (except fuel return line)
- Oil cooling system
- Helicopter structure/contour (except engine cowlings)
- Many items of the optional equipment

The general dimensions (increased length) and the air intake of the Arriel 1-E engine are different compared to the Lycoming engine. Therefore the engine deck arrangement had to be changed.

## Air Intake

The helicopter air inlet system is of a plenum chamber type with a FOD (foreign object damage) screen in front of the two axial engine air inlet ducts. The engine air is taken from the transmission compartment via these air intake ducts, which are mounted to the engine and to the forward firewall.

## Firewall Arrangement

The firewalls separate the engine compartments from each other and from the helicopter components next to the engine compartments. The system contains a forward, a rear and an inner firewall; the inner one is fast removable for better maintenance between the two engine compartments. The firewalls are made out of titanium.

## Fire Extinguishing System

Two fire extinguisher bottles with two outlets each are installed behind the l/h rear firewall. The pipes are routed to each engine compartment. The bottles are equipped with overpressure valves which open a safety discharge line leading overboard. Each engine compartment is equipped with three fire detectors. Two of them are placed on the rear firewall and one is fitted to the engine below the fuel control unit.

## Instruments

The following instruments for monitoring the engine data in the cockpit were modified compared to the BK117 B-2:

- turbine speed (N2)
- exhaust gas temperature
- engine oil temperature and oil pressure

The instrument for the gas generator speed (N1) is a new one.

## Performance Aspects

There is no difference of the performance between the BK117 B-2 and C-1 for standard operating conditions (standard temperatures). The operating range is also similar for both the helicopter versions.

A big difference however can be noticed for extreme hot ambient temperatures at sea level:

In HOGE (hover out of ground effect) there is an increase of the take-off weight by about 300kg for the BK117 C-1 (C-1: 3300kg/ B-2: 2990kg). The take-off weight for single engine service ceiling reaches 3340kg for the BK117 C-1. The BK117 B-2 value for this condition is 2740kg.

## Certification Program

An extensive qualification program had to be performed in order to cover the full range of the helicopter certification requirements. The basic certification tests took place at Ottobrunn. As these tests are - more or less - routine work, a special focus is given to the evaluation for certification purposes which were conducted under severe environmental conditions:

- hot weather tests
- icing tests
- cold start tests
- snow tests

## Hot Weather Test

The hot weather tests took place in Spain in the area of Sevilla. This area is situated at an altitude of about 100ft, that means very close to sea level. The temperatures climb up to 45°C during the summer which is near to the certification limit of the BK117 helicopters (50°C). The test campaign showed positive results with respect to:

- engine oil cooling
- engine compartment cooling (engine accessories)
- helicopter surface temperature measurement
- generator cooling
- performance
- power checks
- measurement of power required, power available
- limiting H-V envelope
- Cat A/B take off and landing performance
- controllability

In addition to these investigations the behaviour of the engine cooling system and engine characteristic during various flight conditions at maximum attainable density altitude (>10000ft) were evaluated successfully in the mountains of the Sierra Nevada near Granada.

## Icing / Snow Tests

The certification regulations require an air intake icing test regardless the helicopter is allowed to fly in icing conditions or not. It must be demonstrated that an ice accumulation on the engine air inlet grid will have no adverse effect on the engine operation or cause serious loss of power.

The icing tests for the BK117 C-1 were performed in the icing (wind) tunnel of the Bundesversuchs- und Forschungsanstalt Arsenal at Vienna (Austria). This wind tunnel is built as a closed loop system and is able to produce temperatures from  $-50^{\circ}\text{C}$  up to  $+50^{\circ}\text{C}$  at different wind speeds and air humidities.

### Configuration of the helicopter:

The main rotor blades and the tail rotor were not installed on the helicopter inside the wind tunnel due to space problems. This results in a reduced mass of the drive system and would lead to a high power turbine speed at a relatively low gas generator speed. For the icing tests however a high gas generator speed is required to realize the necessary high air flow. Therefore the original Arriel 1-E engines were substituted by two gas generator engines (that means engines without power turbines).

### Preliminary tests:

At first numerous tests with different measurement equipments were performed; the adjustment of the spray rig and the proper helicopter position had to be defined in order to get the required conditions for:

- liquid water content
- droplet diameter and
- ice formation

The spray rig (figure 4) consisted of six horizontal pipes each equipped with six nozzles. The distance between the pipes was 0.4m. For each pipe the air pressure and water flow rate was adjustable separately from outside the chamber. The total dimension of the spray rig was 3.8m by 2m.

The required liquid water content and the droplet diameter were adjusted by the combination of the water flow rate, the air pressure per nozzle and an appropriate air-speed of the wind tunnel.

The correct formation of ice was determined by adjusting the distance between the spray rig and the measurement rig.

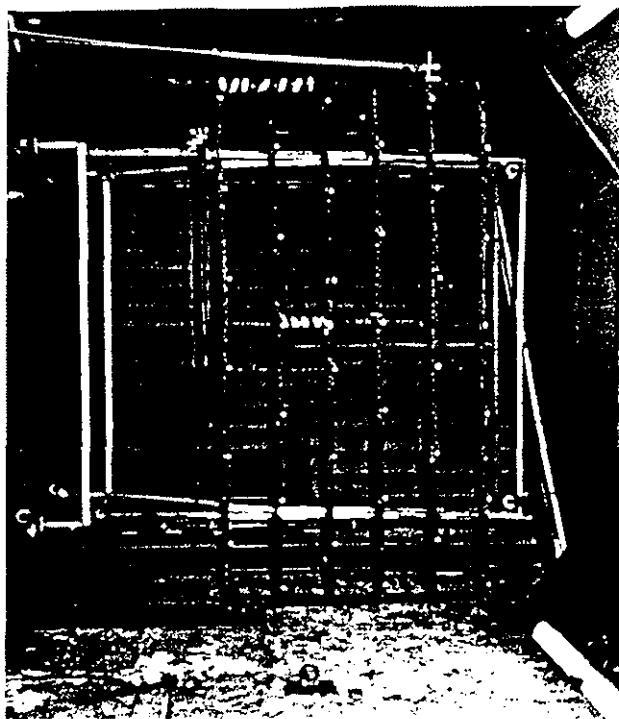

Figure 4: Spray Rig

The following measurement equipment (figure 5) was used:

- forward scattering spectrometer probe  
PMS model FSSP-100, option B
- optical array cloud droplet spectrometer probe  
PMS model OAP-260X
- LWC equipment of the research institute (Vienna)
- theoretical LWC calculation (horizontal/vertical rod)
- indication rods for the ice formation (run back ice, clear ice, milk ice)

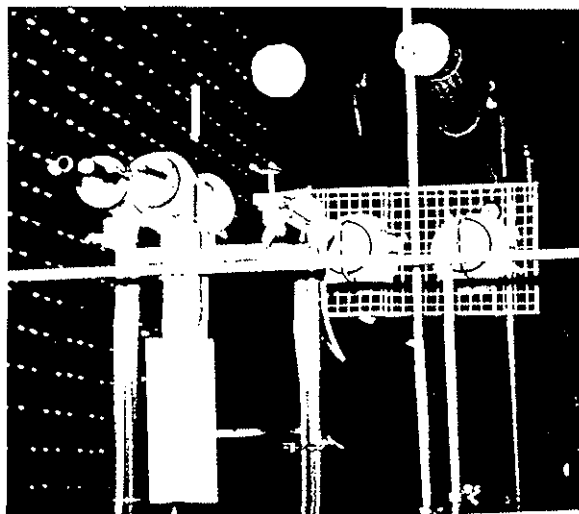

Figure 5: Measurement System

The principle of the FSSP-100, option B is that particles are sized by measuring the amount of light scattered into the collecting optices aperture particle interaction through a focused laser beam.

The OAP-260X sizes the particles by using a linear array of photodiodes to sense the shadowing of array elements by particles passing through its field-of-view. Particles are illuminated by a laser and imaged as shadowgraphs onto the photodiode array. If the shadowing of each photodiode element is sufficient, a flip-flop element is set. The particle size results from a determination of the number of elements set by a particles passage, the size of each array element and the magnification of the optical system.

The LWC equipment of the research institute works based on a voltage difference between two sensors. One sensor was installed in the dry environment of the wind tunnel and the other sensor approximately in the middle of the air/water stream. The water droplets cool down the "wet LWC sensor" and the voltage has to be increased to keep the temperature at the same level as that one of the "dry LWC sensor". The liquid water content has been calculated considering the voltage difference of the sensors, specific heat of water and the latent heat of vaporisation.

Five vertical indication rods were used to determine the formation of ice at different distances from the spray rig. The type of ice accumulation was used to identify whether the water droplets were undercooled or not. Two rods were installed in front of the measurement rig and three behind the rig in a distance of 2 meter from rod to rod.

The measurement equipment was only installed for the icing adjustment tests as the equipment would have had a negative effect on the air/water stream in front of the helicopter air inlet if installed during the real icing tests.

#### Icing tests:

A lot of icing tests were performed in order to fulfill the appropriate certification regulations. Parameters like liquid water content, droplet diameter, test duration,

chamber temperatures and engine power setting (air flow) had to be varied. The airspeed inside the chamber was kept constant at 20m/sec.

After each icing test the airspeed of the wind tunnel and water flow were stopped and the engines were shut down. The ice accumulation was documented and afterwards the wind tunnel was heated up to clean the helicopter components from ice. The next icing test was started after this procedure.

The following data were determined on the engine air inlet grids for each icing test:

- ice thickness
- formation of ice (clear ice, rime ice)
- mesh of the front and basic grid closed or not
- direction of growth of the ice accretion
- estimated open area

The results showed that even the most critical icing conditions with maximum ice accumulation on the engine air inlet screens (figure 6) had no negative influence on the engine operation and no serious loss of power.

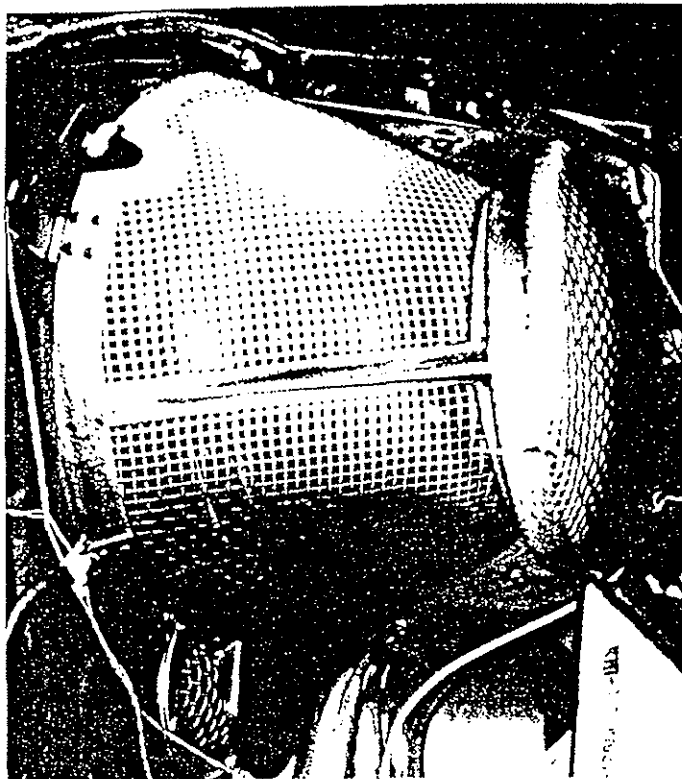

Figure 6: Air Inlet Screen with Ice Accumulation

#### Snow tests:

For the first time EUROCOPTER performed artificial snow tests. The areas of snow accumulation (figure 7) were determined and it has been demonstrated that even under worse snow conditions than required no hazardous amount of snow was accumulated.



Figure 7: Areas with Snow Accumulation

#### Additional tests:

During the same test period the influence of FOD's like plastic bags and clothes on the engine operation and the function of the air inlet screens and its by-pass was tested successfully.

Also pre-investigations concerning the cold start behaviour were done.

#### Cold Start Tests

The certification tests were performed at Ottobrunn in a climatic chamber of the IABG (Industrie-Anlagen-Betriebs-Gesellschaft) in December 1991 based on the pre-investigations at Vienna. The helicopter was placed inside the chamber without main rotor blades

and tail boom due to the limited space. Two experimental exhaust tubes were directly slid over the engine exhaust pipes to lead the exhaust fumes out of the chamber during engine starts.

Before the cold start tests the helicopter was cold soaked down to the respective test temperatures. Several batteries with a charging capacity of 80% were cooled down in a separate climatic chamber to real-ise temperatures different from the helicopter temperature. The batteries were installed to the helicopter just before the starting tests.

It has been proven that the BK117 C-1 can be started at temperatures down to  $-45^{\circ}\text{C}$ ; the battery has to be preheated to  $-20^{\circ}\text{C}$ .

Cold starts at a temperature of  $-30^{\circ}\text{C}$  were performed successfully without preheating of the battery.

#### Snow Tests (Flight Tests)

Fortunately in this winter (1991/92) there were snow conditions at Ottobrunn for two days as required for certification purposes (Advisory Circular 29-2A).

The influence of heavy snow fall on the engine air inlet system and inlet screens was tested successfully during different flight conditions like ground runs, hover flights, level flights and climbs.

The results of the artificial snow tests were confirmed but with much less snow accumulation (figure 8).



Figure 8: Snow Accumulation after Flight Tests



EUROCOPTER therefore believes that with a plenum chamber type helicopter air inlet system in the future artificial snow tests could be used for certification. The very extensive, because hard to realise, natural snow flights could be substituted. Furthermore the artificial snow tests can be done under reproducible conditions.

**Program Status**

The BK117 C-1 certification program for the basic version will be completed towards the end of 1992. The main activities for the next months will be the certification of special optional equipment like particle separator filter and air conditioning system. The actual status of the BK117 C-1 program is given in figure 9.

altitude conditions. This results in a remarkable increase of the take-off-weight.

A successful certification test campaign was performed. One of the milestones (air intake icing tests with a full scale helicopter) was described more detailed in this paper.

EUROCOPTER is confident that the alternate engine concept will further improve the position of the BK117 on the market because it offers the expected flexibility in order to satisfy customer demands.

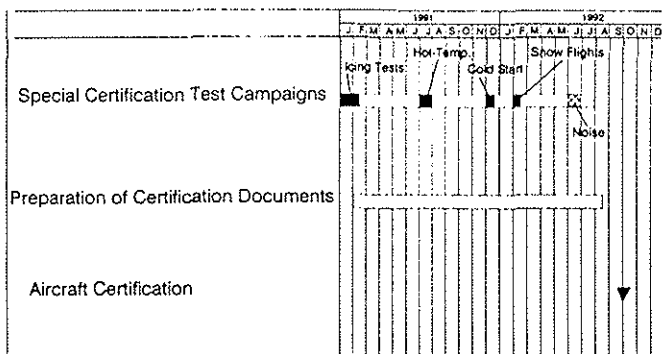

**Figure 9:** Program Status of the BK117 C-1

**Conclusion**

The alternate engine concept (Lycoming or Turbomeca) for the BK117 is based on the development to increase the MTOW from 3200kg to 3350kg. The BK117 B-2 is equipped with Lycoming LTS 101-750 B-1 engines. Turbomeca Arriel 1-E engines are installed on the BK117 C-1.

There is no difference of the performance between BK117 B-2 and BK117 C-1 for standard operating conditions (standard temperatures). The Arriel 1-E engine enables improved performance at hot day/low