

RTM TECHNOLOGY FOR FENESTRON BLADE.

By

BESSE Jean-Luc – GAFFIERO Jacques.

EUROCOPTER.

La Courneuve – FRANCE.

Abstract.

The results of the studies described in this paper concern the work carried out at Eurocopter since 1993 on the RTM technology applied to fenestron blades. The objective of this research program was to define a new blade with a new manufacture technology for Vehicle Demonstrator Fenestron and to compare the results with metal technology and prepreg technology.

This paper begins with a general description of the fenestron blade design and a recall of the technology currently applied to fenestron blades by Eurocopter. After a recall of the RTM technology in terms of principle and advantages, specially for blades applications, we will show RTM Blade definition adapted to the technology (Integration of a lot of functions before the injection step) and a description of the manufacturing in two different main steps (preform manufacturing and injection with an automatic injection system developed during this work). At the end of this paper, as a conclusion, we can say that RTM can be used to produce high performance structural components and Eurocopter has successfully developed a new blade produced by RTM. This blade has been chosen for the new fenestron tail rotor fitted to the new Dauphin version.

1) Introduction.

The results of the studies described in this paper concern the work carried out at Eurocopter since 1993 on the RTM technology applied to fenestron blades.

This work was performed in a research context for quiet fenestron application on Vehicle Demonstrator Fenestron.

The objective of this research program was to define a new blade (airfoil, twist, ...) with a new manufacturing technology for Vehicle Demonstrator Fenestron and compare the results with metal technology and prepreg technology. The target was to improve economical and technical fenestron blade competitiveness.

After feasibility demonstration on specimens during the second half of 1993, we developed and manufactured, from 1994 to June 1996 the blades of the vehicle demonstrators.

During this description we are going to review the following points :

- A general description of the fenestron blade design.
- A short recall of the technology currently applied to fenestron blades by Eurocopter. The objective of this State of the art is to show why and when it could be interesting to use composite technology as a substitute for metal technology.
- A recall of the RTM technology in terms of principle and advantages, specially for blades applications. In this part we want to show why and in which conditions the RTM technology could be a good composite solution for Fenestron blades.
- RTM Blade definition adapted to the technology. In this part we are going to explain how we could make the best use of the advantages of the RTM technology applied to blades.

- In the part dealing with blade manufacturing we are going to see how the blades are made :

* Preform step.

* Injection Step obtained with the RTM automatic pilot system developed during this work.

- And finally, as a conclusion we are going to see the results, our experience at the present time and the prospects of the RTM technology for this kind of blades.

2) FENESTRON BLADE DESIGN.

A Fenestron blade consists of two different main sections, i.e :

The airfoil section.

The attachment section.

The principle of a Fenestron Blade is shown in the drawing below :

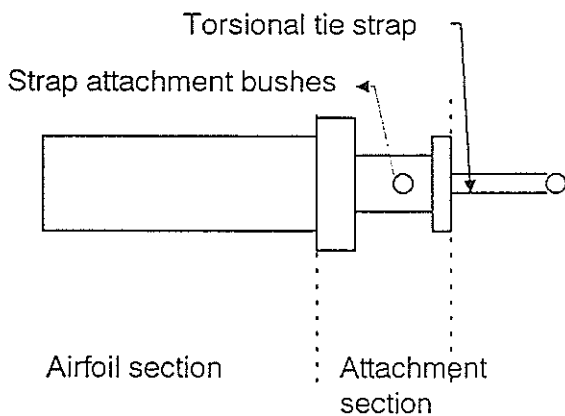

Fig 1.

The airfoil section ensures the aerodynamic function. The profile of composite blades is protected against rain and sand erosion and impact damage by a metal leading edge strip.

The main functions ensured by the attachment section can be briefly described as follows :

- Incidence guiding functions with incidence guiding bushes and pitch horn.

- Link between blade and rotor hub by strap attachment bushes and torsional tie strap.

For a composite blade some or all of these functions are achieved by a metal part.

3) ACTUAL BLADE FENESTRON TECHNOLOGY.

On the Eurocopter helicopter fenestron, we have today two different technology families.

GAZELLE - EC120 - EC135 - DAUPHINS N - C => Totally solid metal Technology.

DAUPHINS N1 - N2 => Composite technology with prepreg fabrics.

Today for blades with a short chord in the airfoil section (as on the EC120, EC135...) Eurocopter has opted for the totally solid metal technology. When the chord is increased to gain more power on the tail rotor, as the case when the Dauphin N was upgraded to the Dauphin N2, Eurocopter will switch from the metal to the composite technology.

The figure below shows the evolution of the weight of the outboard section according to its chord.

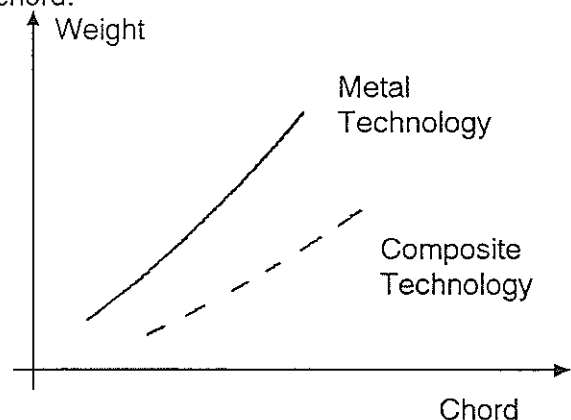

Fig 2.

If we consider only the mass factor, when the chord increases the solution is composite material.

But if we consider only the cost factor, the totally solid metal technology is always more attractive.

If we take into account other parameters (control load, hub weight,...), the choice is totally solid metal technology for small chord blades and composite technology for wider chord blades.

4) RECALL OF THE RTM TECHNOLOGY PRINCIPLE.

The manufacture of RTM (Resin Transfer Molding) composite parts consists of two main steps.

During the first step a composite preform with dry fabrics is made (This preform has the same geometry as the final composite part).

During the second step the preform is put into the injection mold for the injection (The mold is subjected to negative pressure and then the liquid resin system (with low viscosity) is injected through the preform into the mold under a low pressure).

After the injection a conventional curing cycle for composite parts is carried out.

Preform manufacturing.

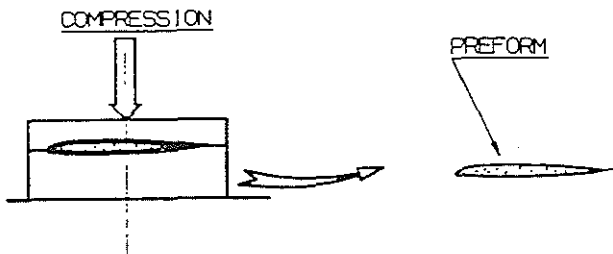
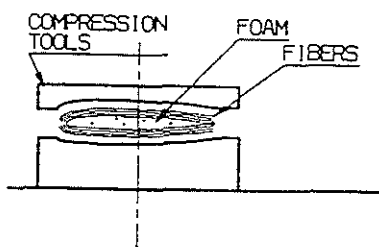
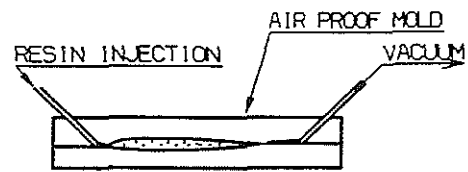
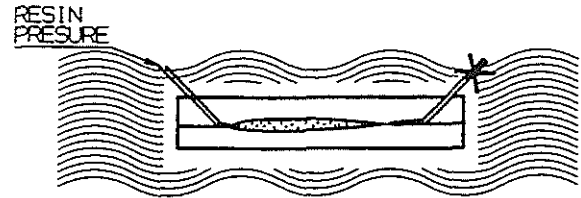

Fig 3

Injection.



INJECTION PHASE



CURING PHASE

FINAL PIECE



Fig 4.

The main advantages of this manufacturing technology are :

The composite part after the injection step can be the final part.

The surface aspect is very good. RTM can produce complicated shapes that require mold finished surfaces on all sides.

The structural composite health is very sound. The RTM process produces low void content product.

We can reduce the finishing operations by integrating a lot of functions (Metal parts ...) before the injection step.

The reproductibility of this process is very high. For the injection step it could be possible to use an automatic machine.

5) RTM BLADE DEFINITION.

One of the problems we had to solve during this study was to find a blade definition compatible with blade specifications and with RTM technology, because we had to keep all the advantages of the RTM technology (both economical and technical).

The principle of the optimal version is shown in the drawings below :

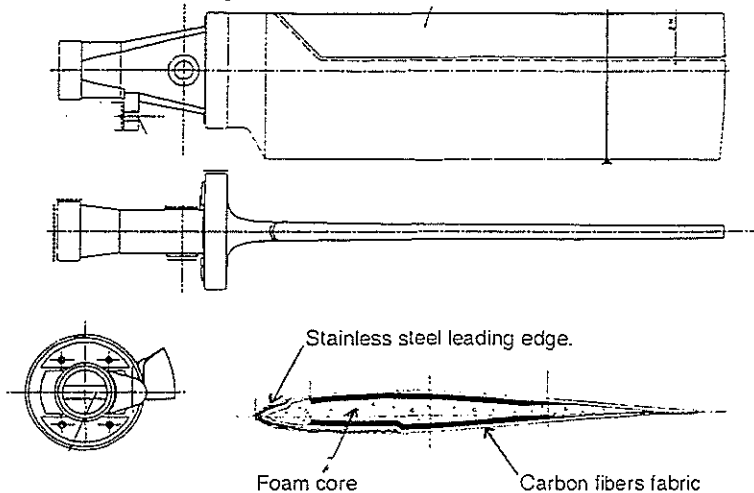

Fig 5.

As seen earlier, one of the advantages of the RTM technology is to integrate all functions into the preform before injection. These will result in:

- High composite quality.
- Reduced manufacturing price.

This guiding principle was followed during the definition of this new blade. All of the following parts are integrated into the preform :

- Leading edge erosion strip (with impact behaviour improvement)
- Strap attachment bushes.
- Incidence guiding bushes.
- Carbon pitch horn.

The result of the highly integrated functions is such that when opening the injection mold, after

composite curing cycle, the blade is close to the final blade with a very high quality and reproductibility.

Materials.

At the beginning of this work, we had to choose the material adapted to RTM and to mechanical blade specifications.

For economical reasons the number of different materials must be reduced. This will result in cutting down receiving inspection and purchase costs on the one hand. On the other hand the materials thus selected will be less sensitive to such uncertainties as : environmental conditions, manufacturer's policy, etc. This is why, for this blade, we chose :

- One standard carbone fiber fabrics currently used in other helicopter part.
- And one resin system adapted to our mechanical specifications and RTM processing specifications. When selecting a resin system for RTM different criteria must be considered.

Resin choice.

In first stage, the resin system must meet the blade specifications, i.e :

- Mechanical data on dynamic and static after ageing under the action of temperature in wet conditions.
- Damage tolerance behaviour.
- .../...

In a second stage the resin system must be adapted to the RTM technology in terms of processing. The process involves placing dry reinforcement fibers in a closed mold which is subsequently injected with a low viscosity resin. To be suitable for RTM the resin system must remain a sufficient time at a low viscosity. High viscosity resins require higher injection pressures which can result in the production of low quality parts due to poor fiber wet out or fiber displacement or foam cells destruction.

After a characterisation program (Processability choice, Mechanical behaviour, Physico-chemical analysis) carried out on different resin systems

combined with the carbon fiber we selected the one component RTM6 180°C class resin system.

Profile.

The profile of this blade is the result of Eurocopter research program on fenestron blades. The chord of this blade is wider than the present Dauphin composite blade.

6) BLADE MANUFACTURING.

Preform manufacturing.

The preform is made from reinforced fiber material. The reinforcement material is made of carbon fiber with less than 6g/m² of epoxy powder on each individual side. This powder is used to stick each ply to each other during the preform manufacturing. In a first step we produced the blade in two preforms, the upper and the lower. After that, both preforms are assembled together to constitute the integral blade preform. A machined foam filler is inserted between the upper and lower halves in the outboard section. Before the injection step the dry preform is assembled with all the metal parts referred to above.

- A hole is made in a dry preform for bushing installation.
- The leading edge and the incidence guiding bushes are placed on the dry preform.

The whole preform manufacturing is achieved in a special mold.

This preform is without structural resin as with prepreg composite products. It can therefore be stored for long period of time (more than 6 months) without specific equipment like cold rooms being required.

Injection.

We are using a simple closed mold in which metal parts are secured in position during injection. The mold outlet is connected to a

vacuum pump. The inlet is connected to a heated resin can via a heated line. (Fig 6).

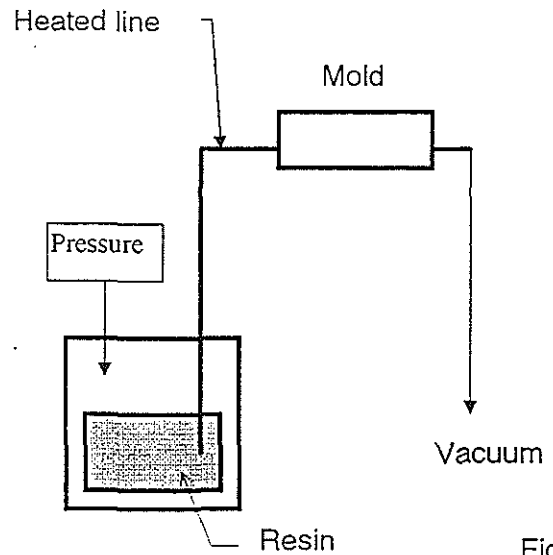

Fig 6.

For the injection step we have to control a lot of parameters. That is to say :

- Mold, resin, heated line temperatures.
- Vacuum and pressure levels. Resin must be injected at a pressure that will not compress the foam.

When all of these parameters have been considered, RTM can become a rather complicated process. Achieving quality in this process involves control of such parameters. This is why we started to develop during this work an automatic injection system operating when all parameters have been reached.

Before and during resin injection precautions must be taken to ensure that no air is injected with the resin. If not we can obtain a finished product with air inclusions. This is why we use vacuum to draw the resin into the mold. In addition, the resin is degassed prior to injection into the mold.

The resin enters the mold which has been set at a higher temperature to reduce the resin viscosity and facilitate the fiber wet out.

7) RESULTS.

We have now produced more than 40 blades for the quiet ducted helicopter tail rotor during the research program that included 24 flying blades and 16 test blades.

We have successfully carried out dynamic and static tests on the different parts of the blade, ie:

Carbon pitch horn (On specimen and on attachment blade section). (Fig 7).

Blade tes (outboard section). (Fig 8).

Attachment blade cross section and specimen.

Test on incidence guiding bushes (Bonding behaviour of the incidence guiding bushes on composite blade).

Leading edge impact test.

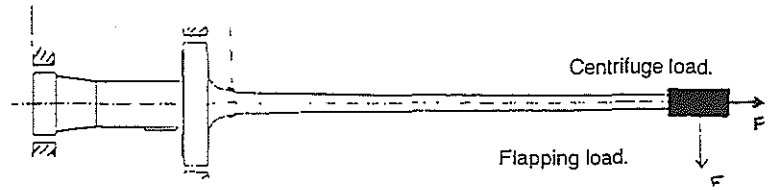

Blade test. (Fig 8).

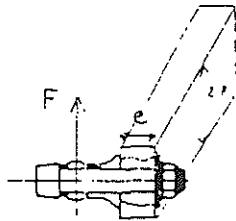

Carbon pitch horn
Specimen

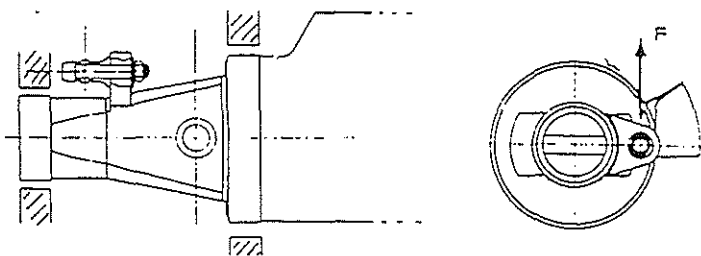

Carbon pitch horn
Attachment blade section.(Fig 7)

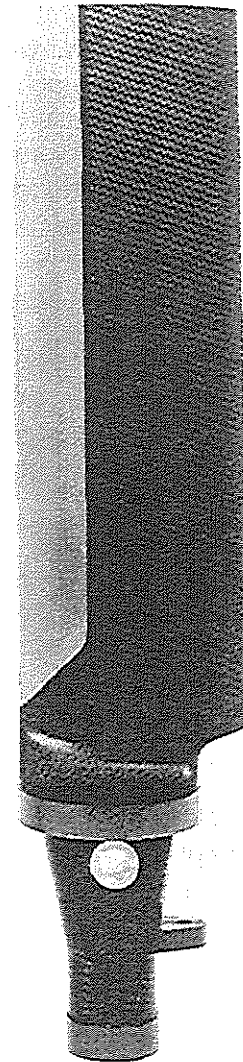

8) CONCLUSION.

Our conclusion is that RTM can be used to produce high performance structural components.

The RTM process gives a good trade off in terms of performance, cost, weight on the fenestron blade for helicopters having a size similar to that of the Dauphin.

After an optimisation program of the design following the experience gained in the first flights and the manufacturing of a large quantity of blades Eurocopter has selected this blade for the new fenestron tail rotor fitted to the new Dauphin versions :

The « high performance » AS 365-N3 is specially designed for use in severe altitude and weather conditions. This version is currently undergoing intensive testing that began in late October 1996. Certification is expected by mid-1997 with deliveries scheduled to begin the second half of 1997. About 20 Dauphin N3s have already been sold or are in final stages of negotiation.

The « Wide Body » AS 365 N4, with a completely redesigned cabin offers outstanding comfort for the transport of 12 passengers. The first preproduction machine is expected to take the air during the third quarter of this year. The program provides for certification of the new version by mid-1998, with initial deliveries to follow in the second half of that year.



AS 365 N4,