

TWENTYFIFTH EUROPEAN ROTORCRAFT FORUM

Paper n° N8

**LYNX LIFE EXTENSION ACTIVITIES IN
THE ROYAL NETHERLANDS NAVY**

BY

J.G. VAN DER HORST, LTCDR L. MELISSANT
ROYAL NETHERLANDS NAVY

SEPTEMBER 14-16, 1999
ROME
ITALY

ASSOCIAZIONE INDUSTRIE PER L'AEROSPAZIO, I SISTEMI E LA DIFESA
ASSOCIAZIONE ITALIANA DI AERONAUTICA ED ASTRONAUTICA

(

(

(

LYNX LIFE EXTENSION ACTIVITIES IN THE ROYAL NETHERLANDS NAVY

J.G. van der Horst
Technical Specialist Airframe
Department of Naval Aircraft Engineering and Maintenance
Royal Netherlands Navy
P.O. Box 20702, 2500 ES The Hague, The Netherlands

LtCdr L. Melissant
Head of Maintenance Engineering
NAS De Kooy
P.O. Box 10000, 1780 CA Den Helder, The Netherlands

"Mr. Murchison asked the Secretary of State for War whether he can state the average life in flying hours under peace conditions of two-engined aeroplanes capable of carrying 20 to 30 passengers. Capt. Guest replied that there is no reason why any aeroplane should ever wear out as, after 200 hours flying, there will probably be very little of the original machine left."

Flight International, 1 January 1920

Summary

As it became apparent in the early 90's that the successor of the Royal Netherlands Navy's (RNLN) GKN Westland Lynx SH-14D could create a gap in time at the end of the life of the Lynx, there was a need to actively pursue a life extension investigation.

Furthermore it was deemed necessary with regard to safety to review the actual fatigue life of components, such as structural items, gearboxes and rotor heads, based upon the actual RNLN usage of the Lynx.

With ref. [1] indications were given on the RNLN activities to fulfil these aims. This paper reports on the progress to date and the activities in the near future.

Co-operation between Maintenance Engineering of the Maintenance Department of Naval Air Station De Kooy and the Design and Maintenance Authority, being the Department of Naval Aircraft Engineering and Maintenance of the Directorate of Materiel of the RNLN resulted in improvements in both available life

of the GKN Westland Lynx SH-14D helicopter, as well as an optimised maintenance programme and a clearer view on the necessary actions to be taken to extend the life of the RNLN Lynx further in the future.



Figure 1 RNLN GKN Westland Lynx SH-14D

1. Introduction

The helicopter fleet of RNLN consists of 21 GKN Westland Lynx SH-14D. These helicopters operate in various roles, such as Anti-Submarine Warfare (ASW), Anti Surface Warfare (ASuW), Counter Drugs (CD) operations and Search and Rescue (SAR). About 6 of the helicopters are stationed aboard one of the RNLN ships (frigate, supply vessel, amphibious transport ship). The remaining helicopters are operated from their home base Naval Air Station De Kooy in the Northwest of the Netherlands, where they are also maintained.

Having a wide variety of roles and operating from land bases as well as from ships, maintenance ought to be as flexible as possible. This, in the opinion of the RNLN, requires being a smart operator and a smart maintainer.

GKNWHL's policy with regard to life extension is to re-airframe the Lynx, thus bringing back the airframe to zero life. The RNLN have taken another approach, which is, according to GKNWHL, appropriate for the RNLN Lynx.

The RNLN have been active in the recent years in three main areas with regard to the issues related to the structural integrity of the Lynx:

- safe life related usage aspects;
- management of actual usage;
- optimisation of the maintenance programme.

The aim of these activities is to get the optimum maintenance, in combination with the optimum usage of each individual helicopter, to finally achieve the necessary life to bridge the gap to the successor of the Lynx, as well as to carry out the most economic and airworthy maintenance programme, bearing in mind the operational commitments. Focusing on the maintenance concept, this means that the RNLN would like to maintain a safe life based system as long as possible, if necessary succeeded by an on condition system. The results will be based on the outcome of an international life extension programme, led by the UK Ministry of Defence (UKMOD).

2. Current and ongoing activities

2.1. Safe life related usage aspects

The Lynx was designed in the 60's with an envisaged design life of 7000 flying hours. This life was based on an UKMOD dictated usage spectrum. This requirement has been the basis for the RNLN maintenance programme, including component fatigue lives.

As usage normally differs from user to user, the RNLN started an investigation to determine the actual usage in 1995. The intention was to fly all the different missions several times and having a dedicated person to record the relevant flight parameters by hand.

01	Transport/Navigation
02	Jumpex
03	Deck landing practice
04	General
05	Instrument
06	Test
07	Towing
08	Demo
09	SAR
10	External load
11	Confined/slopes
12	Flyex
13	MIF (boarding/BBE)
14	Other

Table 1 Missions

The parameters which were necessary to be logged were determined in co-operation with GKNWHL, ref. [2]. It appeared that, with the accuracy required, it would be rather easy to determine the usage of the Lynx, as the accuracy required for the various parameters allowed the use of a man-monitored survey. The method chosen was named PLUMS (Paper Lynx Usage Monitoring System). An example of the form used can be found in annex A.

During the preparation, one of the team members changed the pencil and paper system into a laptop PC system, resulting in the renaming in CLUMS (Computer Lynx Usage Monitoring System). All flight parameters could then easily be stored. With these data and the already existing database with flying hours and mission identification, a standardised RNLN Lynx flying hour has been

deducted, which was verified by interviewing pilots. The results were also discussed with GKNWHL as designer of the helicopter.

a	Mission type
b	Take-off centre of gravity; fwd/mid/aft
c	Cruise speed; high/medium/low
d	Hover time
e	Hoist time; 1/2 persons
f	Sonar dunking time
g	Maximum power climb time
h	Flight duration
i	Transitions from and to hover
j	Turns > 45° bank angle
k	Turns 30-45° bank angle
l	Ship landings
m	Shore landings
n	Payload change

Table 2 Usage parameters

Subsequently GKNWHL was granted an order to carry out new safe life calculations, using the standardised RNLN Lynx flying hour. From the Lynx lifing point of view these calculations intended to obtain new safe lives for all structural components, as well as certain dynamic components, such as gearboxes and rotor components to determine the current and future status of the Lynx. As a second aim, more from the flight safety point of view, it was the intention to obtain more realistic safe lives and thus amend the original assumptions made during the determination of the design usage spectrum.

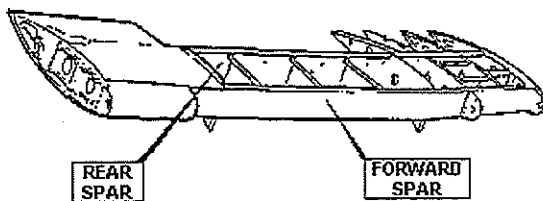

Figure 2 Sponson

Apart from the area of safe lives, one specific issue, the life of the sponson spar, needed to be resolved. The life of the sponson spar is dependent on the number of landings and the loading during a landing. The landing speeds, which in part determine the loads, assumed by GKNWHL are higher than supposed by the RNLN. As no data is available to validate this, the RNLN have also planned activities in this area.

2.2. Management of actual usage

Based on the number of flying hours for which the Lynx originally was designed, the RNLN already concluded at an early stage that problems might occur with the anticipated transition plan to the successor of the Lynx, especially with the life of certain structural components, such as Main Rotor Gear Box (MRGB) attachment, which have a declared life of 7000 flying hours.

Based on the number of landings, as well as the proportion between land landings and deck landings, problems were also foreseen with the life of the sponson. Original life calculations are based on the assumptions that loads during deck landings are twice the loads during land landings and the original spectrum is based on a ratio of 50% deck landings and 50% land landings. Earlier work already translated the flying hours based life to a life based on number of landings, ref. [3].

Therefore it was decided to set up a management plan, in which the major aim would be to obtain a proper distribution of flying hours per individual Lynx, as well as a better proportion between land landings and deck landings. This management plan required the involvement of all parties, i.e. both maintainers and operators. It was considered possible to control the actual flying hours and landing parameters by tail number by e.g. dedicating certain Lynxes as ship's helicopter (those which have much less ship deck landings than land landings) and the other way around. All possible means were exploited.



Figure 3 Lynx aboard a frigate

2.3. Optimisation of the maintenance programme

The maintenance concept of the RNLN Lynx is based on usage related inspections (calendar time, number of landings, hoist operations, etc.), as well as calendar inspections. These inspections are then clustered into so called flexops to ease the maintenance process. The airframe is inspected on a zonal basis. The maintenance concept does not contain any airframe related depot maintenance. This results in the situation that never during the entire life of the helicopter the airframe needs to be inspected for corrosion and/or cracks with the accuracy one can see in civil aviation and e.g. the Standard Depot Level Maintenance of the RNLN Lockheed-Martin P-3C Orion Maritime Patrol Aircraft.

To enable ongoing operations beyond 7000 hours, it would be necessary to determine if the existing maintenance concept catered for maintaining the airframe condition in a fit state. Therefore it was decided to determine the airframe condition of two representative Lynx helicopters by carrying out Mid-life Airframe Corrosion and Husbandry Operations (MACHO), combined with a Structural Condition Survey (SCS). Based on this MACHO/SCS programme it would be decided if there were reasons to carry out a MACHO programme on the whole fleet.

In co-operation with GKNWHL a special inspection was set up, containing complete paint stripping of the aircraft, removal of various components and installations and detailed inspections, relating to the aims of the MACHO/SCS programme.

Parallel to MACHO/SCS a programme was set up to get more detailed information on Structural Significant Items (SSI). The existing maintenance documentation does not categorise the various structural items in relation to their function in detail. GKNWHL has only divided the structure in three categories, i.e. primary, secondary and tertiary structure. Primary structure is defined as "any part of the structure in which a failure in flight, landing or take-off, might be a direct cause of structural collapse, loss of control, failure of motive power, unintentional operation of, or

inability to operate, any services or equipment essential to the safety or operational function of the aircraft, or injury to the occupant." Result of this definition is that almost the complete structure is considered to be primary structure. This is mainly because not only strength and fatigue are taken into account, but also other criteria, like secondary safety. For future maintenance activities, the RNLN would like to introduce more dedicated criteria to establish the structure categorisation. Therefore it was necessary to refine the three categories, more concentrating on the technical functions of the structural items. Thus, five different categories were established:

- fatigue sensitive (lifed), highly stressed structure;
- medium stressed, damage sensitive structure;
- low stressed, damage tolerant structure;
- non-stressed structure, used for safety and/or protection;
- non-stressed structure, used as cover and/or streamline.

An example can be seen in figure 4, where the indicated items are of the first category.

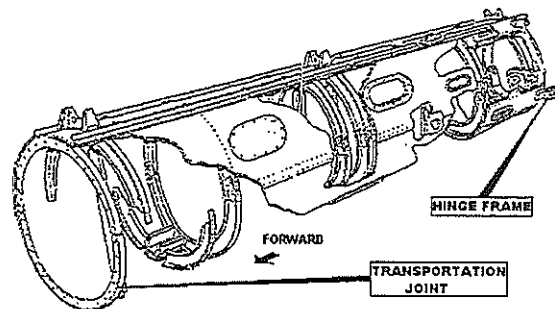

Figure 4 SSI examples in the tail cone

An example of the categorisation for the general layout of the Lynx is shown in figure 5.

2.4. Usage monitoring

The RNLN have been monitoring already for many years the engine cycles with a Cycle Counter on three aircraft. When also the need arose to monitor the rotor speed, it was decided to design a system, which would combine the functions of engine cycle monitoring and rotor speed monitoring. Due to the available options, it was rather easy to

implement some other parameters to be monitored, a.o. speed, bank angle and sponson strain. These data could be used for determining the validity of the usage spectrum. This system, called Automatic In-flight Data Acquisition (AIDA) system is described in ref. [4].

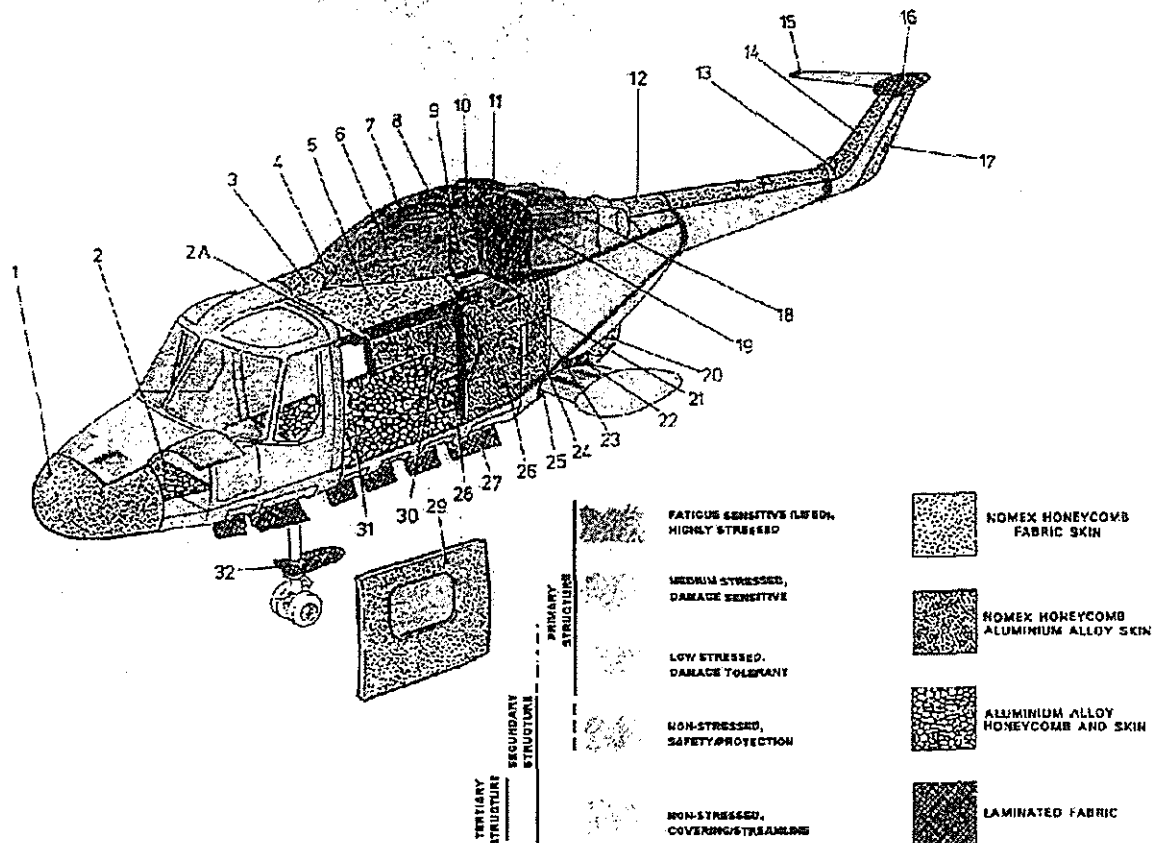

Figure 5 General arrangement SSI; doors, fairings, covers, cowlings

3. Results

3.1. Safe life related issues

In general the results tended to be very positive from the safe life calculations GKNWHL carried out. This meant that the RNLN usage is more benign than the usage which was anticipated during the design of the Lynx. Besides structural also dynamic

components were reviewed. Out of this investigation it can be concluded that there will be cost savings.

Table 3 shows the safe lives for the first part of the Lynx life, when the RNLN Lynx operated with Metal Main Rotor Blades (MMRB) and for the current part, where the RNLN Lynx is operating with Composite Main Rotor Blades (CMRB). As can be seen from the examples, all lives have increased, except for the Tail Rotor Hub Flapping Link, which has decreased.

The final safe life is a combination of both and depends on the airframe hours at which the aircraft were modified from MMRB to CMRB configuration. As can be seen the results for certain dynamic components are impressive. However, one has to bear in mind that the majority of the dynamic components are common pool items, meaning that they are shared with other users and that not the benefit of the complete increase of life is gained but only a proportion of it.

ITEM	ORIGINAL LIFE		NEW LIFE	
	MMRB	CMRB	MMRB	CMRB
Main rotor hub	5025	5254	7762	5583
Intermediate gearbox input pinion	3376	2510	7929	7929
Tail rotor hub flapping link	7329	7000	6174	6141
Airframe-gearbox attachment aft port	7062	7000	14208	7785
Airframe-gearbox attachment aft starboard	7069	7000	12075	8312
Support beam forward port	8025	7000	7044	7605
Support beam forward starboard	19573	7000	16756	7605

Table 3 Calculated safe life examples

3.2. Management of the actual usage

A combined effort was put in by both the maintenance department and the operators to implement the management plan, adopted in 1996, to try to optimise the usage of each Lynx to achieve the aims mentioned in chapter 2.2. Progress towards results was slow (as expected), due to the unpredictable aspects in maintenance and operations. After approximately three years however the management plan has proven its benefits. This can be shown by the difference in dot location, shown in figures 8 and 9 in annex B. A move towards the 50/50 deck/land landing line has been accomplished for those Lynxes which had a high deck/land landing ratio. It also shows that the amount of landings per flying hour has improved for those Lynxes where this figure was too high (i.e. gone down).

3.3. Optimisation of the maintenance programme

The MACHO/SCS was performed on one Lynx at NAS De Kooy. This required the complete paint stripping and removal of many components and equipment to enable proper access to all areas described in the Structural Survey Inspection Report. A quick glance at the bare Lynx already gave the impression that the overall condition appeared to be very good, although the structure was 19 years old and has been in service continuously in a severe maritime environment (one of the worst in the world). Further detailed inspections revealed no significant technical deviations. All the defects found were easily repairable and were not at all cause for any immediate or short term concern. Out of this analysis the RNLN would get a better impression for the longer term usage (until and beyond 7000 flying hours) with regard to the structural integrity (e.g. existing repairs).

After having determined the SSIs, this programme was taken aboard as part of the international programme, led by UKMOD, as mentioned in chapter 1.

3.4. Usage monitoring

Currently, the RNLN is in the process of fitting the AIDA system in all Lynx helicopters. Preliminary results from the first few trial flights already indicate that landing speeds appear to differ from what has always been assumed.

4. Conclusions

4.1. Summarised results

The activities, carried out by the RNLN, and in co-operation with others, have resulted in:

- A better distribution of the landing parameters and flying hours across the Lynx fleet.
- The observation that the current condition of the airframe, related to its age, is in quite an ideal situation.

- The safe lives of a majority of components have increased. Therefore the overall cost for these components will be less than anticipated.
- Only one structural item needs replacement based on its safe life (i.e. support beam forward port).

are thus following the advice of GKNWHL. Considerations to take this approach were:

- the result of the MACHO/SCS programmes;
- that no valid data exist for Lynx, which have been operating beyond 7000 hours;

This future survey programme should give the confidence to operate the Lynx beyond 7000 hours.

4.2. Future activities

As already stated, the RNLN usage spectrum appeared to be more benign than the original design usage spectrum. Resulting from the calculations, further conclusions were drawn to emphasise to the operators the importance of "careful" flying. This was done by giving briefings to the pilots what the effects are on certain components if they fly outside the flight envelope or fly certain manoeuvres more frequently than anticipated in the usage spectrum, which results in a negative effect on the usage spectrum and thus on the safe life of the Lynx and its components.

The RNLN decided to try to limit demo flying to the minimum. This was further emphasised by GKNWHL, which in fact took the same position by issuing ref. [5], stating "that Display Flying manoeuvres which exceed the flight envelope and/or occur frequently so that the usage spectrum would be modified, will degrade the life of the airframe and a certain number of components."

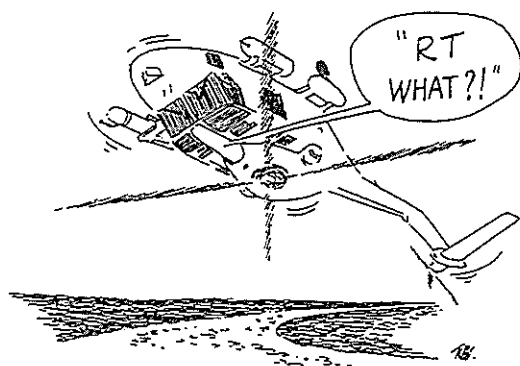

"... vigorous "transient" manoeuvres ..."

Figure 6 Demo flying

The RNLN intend to carry out a second survey programme on all Lynx helicopters when they approach 7000 hours. The RNLN

As certain major components have unfortunately not gained enough safe life to enable Lynx operation until the Planned Withdrawal Date from service, it will be necessary to carry out a replacement programme, for which the preparations are currently in progress. One of them is the support beam (see figure 7), which is located on the deck of the Lynx, and is the connection between MRGB and airframe. It is also part of the main load path.

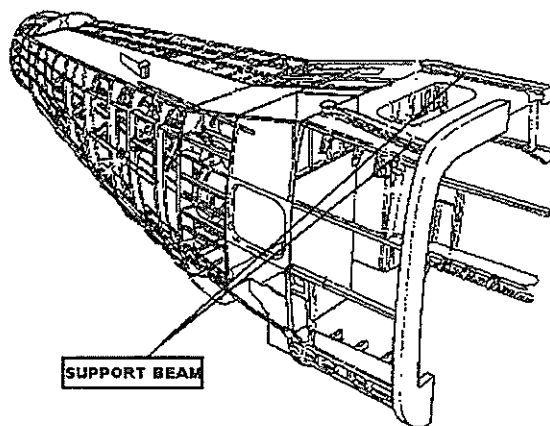

Figure 7 Main load path with support beams

Activities with regard to usage monitoring with the AIDA system will be expanded as much as possible, first to obtain reliable confirmation that the usage spectrum currently used is correct and secondly to obtain more reliable data with regard to landing speeds. Further advantage in this area is the possible option to delete certain factors used to safeguard the theoretical assumptions in the safe life calculations. This might give more improvement in safe life of components.

5. Recommendations

5.1. Safe life related issues

It has been shown that out of a relatively simple exercise of usage determination the RNLN have gained quite a lot of Lynx life. This knowledge also contributes to airworthiness, confidence in maintenance and awareness of actual operations. Therefore the RNLN are of the opinion that each operator confirm its usage spectrum and the effectiveness of its maintenance procedures.

5.2. Optimisation of the maintenance programme

It is deemed necessary to emphasise the actual implementation of the SSI structure as described in chapter 2.3 in the maintenance/repair manuals of the Lynx to obtain a more common-sense approach to simple repairs. This would in general allow for less complicated and thus cheaper repairs.

References

- [1] Van Zwol, MSc, Lt.Cdr. H.J.M. and H.J.M. Zijm. *The Royal Netherlands Navy's approach to Lynx life extension*. 22nd European Rotorcraft Forum, Brighton, 1996
- [2] Davidson, M.S. *Generation of a revised usage spectrum for the calculation of component retirement lives*. W.E.R. 652-06-01028, Westland Helicopters Limited, November 1994
- [3] Ten Have, A.A. and A.J.P. van der Wekken. *Sponson fatigue life evaluation of RNLN Lynx Helicopters*. SB-88-009C, National Aerospace Laboratory NLR, March 1988
- [4] Vergroesen, Lt.Cdr. A.L. *AIDA - An Automatic In-flight Data Acquisition system for the RNLN Lynx helicopter*. AIMS 98, Garmisch-Partenkirchen, 5-6 May 1998
- [5] *Display flying*. Lynx Product Advisory Notice LX/PAN/037 issue 1, GKN Westland Helicopters, 21 August 1998

PLUMS

A/C NO	
DATE	
PILOT	
MISSION	

AUW	
TOCG	
FUEL	

MINUTES

		HIGH	MEDIUM	LOW
1	CRUISE			
2	HOVER			
3	HOIST	10N	20N	
4	SONAR HOVER			
5	MAX PWR CLIMB			
6	FLIGHT TIME			

NUMBER OF

7	TRANSITIONS			
8	URNS>45°	<table border="1"> <tr><td>NUMBER</td><td>TIME</td></tr> </table>	NUMBER	TIME
NUMBER	TIME			
9	URNS>30°	<table border="1"> <tr><td>NUMBER</td><td>TIME</td></tr> </table>	NUMBER	TIME
NUMBER	TIME			
10	LANDINGS/SHIP			
11	LANDINGS/LAND			
12	LANDINGS/DUMMY DECK			

PAYLOAD

KILO	(+/-)	TIME

OTHER

TURBULENCE
 SLINGLOAD
 AUTOROTATIONS
 RUNNING LANDINGS

(NUMBER)
 (NUMBER)

OTHER ITEMS

INSTRUCTIONS FOR USE OF PLUMS FORM

1. This form shall be filled in during/after selected flights. The information will be used as an important source to assess the possibility to extend the life of the Lynx. It is important to fill in the data as accurate as possible.
2. Legend:

Mission:	1. Transport/navigation 2. Jumpex 3. Deck landing practice 4. General 5. Instrument 6. Test 7. Towing	8. Demo 9. SAR 10. External load 11. Confined/slopes 12. Flyex 13. MIF (boarding/BBE) 14. Other
----------	---	---

AUW: All up weight

TOCG: FWD: CG forward of 50mm FWD
 MID: CG between 50 mm FWD and 100mm AFT
 AFT: CG aft of 100 mm AFT

FUEL: Fuel quantity

1. Cruise speed:
 - HIGH: > VNO-20
 - MEDIUM: VNO-50 to VNO-20
 - LOW: < VNO - 50 (below 30 kts HOVER)
 Check flight envelope for VNO. Calculate VNO for weight and altitude.
 2. Hover: All hovering, except the time spent with load in the hoist or sonar dunking (speed < 30 kts).
 3. Hoist: Time spent in hover, with load on hook - 1 person or 2 person or equivalent load.
 4. Sonar hover: Time spent in hover on sonar dunking mode.
 5. Max pwr climb: More than 90% dual torque.
 6. Flight time: Duration of 1-5 is given in minutes and adds up to the total duration of each flight.
 7. Transitions: To and from hover.
 8. Turns with more than 45 degree bank: Count the number of applications of bank and the time of application. Example: four consecutive quarter turns (left-right-left-right) is four applications, a 360° or 270° turn is one application of bank.
 9. Turns with bank between 30 and 45 degrees: Count the number of applications of bank and the time of application. Example: four consecutive quarter turns (left-right-left-right) is four applications, a 360° or 270° turn is one application of bank.
 10. Landings/ship: All landings on ships.
 11. Landings/land: All landings on land, excluding dummy deck landings.
 12. Landings/dummy deck: All dummy deck landings.
- Payload change: Change in weight, positive or negative and time into the sortie. Try to be as accurate as possible.
- Other: Other items which have an influence on the structure should be described. Note: if backward or sideward flying can be recorded with accurate airspeed, record time and airspeed here.

Missions:

1. Transport/navigation: 1 take-off/1 landing/no high velocity/no severe power variations/no steep turns
2. Jumpex: long hover periods (\pm 1/3 flight time)/5-6 dips per sortie/high velocity between dips/steep turns/large power variations
3. Deck landing practice: steep turns/many landings with harpoon engagement/large power variations/long hover periods/low speed flight
4. General: heavy mission containing all flight elements
5. Instrument: light mission/autorotations/angles<30°
6. Test: heavy/large power and speed variations/spot turns (60°/s)
7. Towing: light/long hover periods with hoist/ 5-6 hoist actions per sortie/excentral loading
8. Demo: heavy/partly as mission 1
9. SAR: heavy loading/high speeds/bad weather conditions
10. External load: light flight actions/max. 20° angle/max. speed 60 KTS/max. central load 400 kg
11. Confined/slopes: max. nose-banking angle 7-12°/3-4 landings per sortie/partly as mission 1
12. Flyex: flown by 860 squadron only/also deck landing practice
13. MIF (boarding/BBE): heavy loading/long hover periods with hoist/excentral loading
14. Other

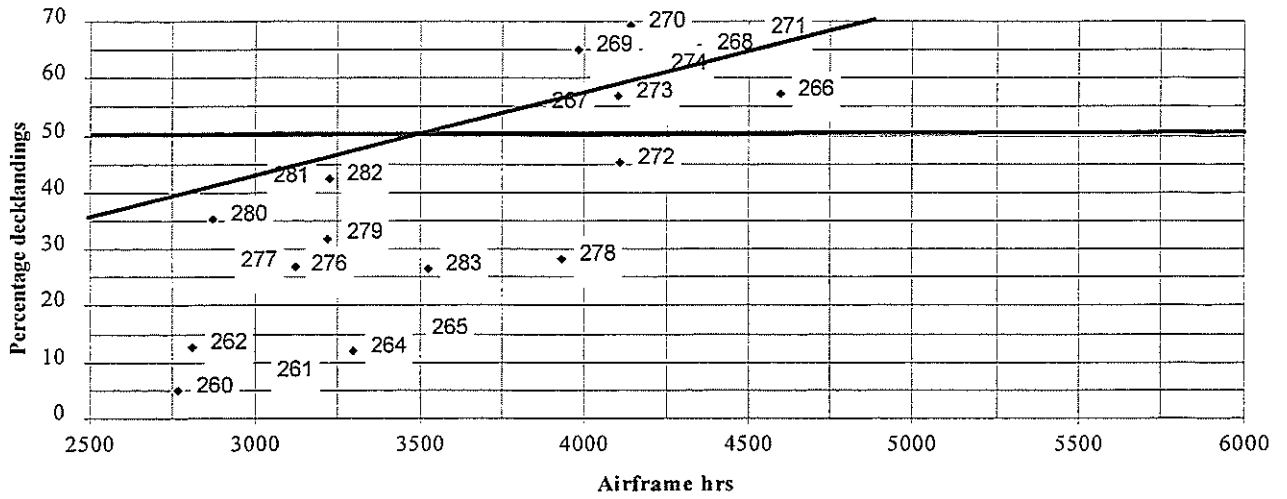

Figure 8 Landing data per May 1994

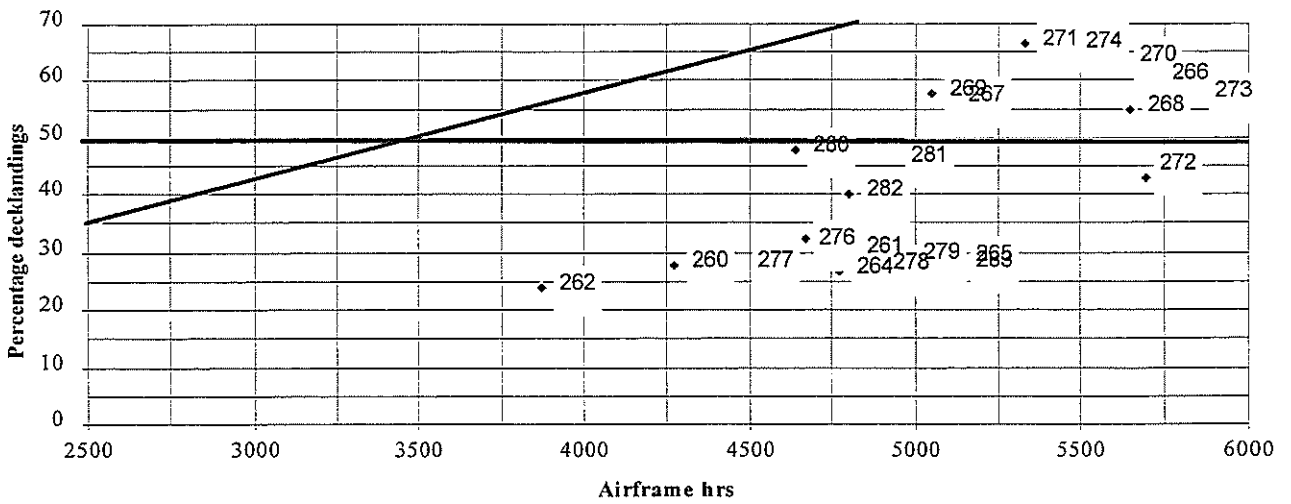

Figure 9 Landing data per July 1999