

**TWELFTH EUROPEAN ROTORCRAFT FORUM**

Paper No. 13

**EXPANDING TILT ROTOR CAPABILITIES**

J. M. Drees  
Bell Helicopter Textron Inc.  
Fort Worth, USA

September 22-25, 1986

Garmisch - Partenkirchen  
Federal Republic of Germany

Deutsche Gesellschaft für Luft- und Raumfahrt e. V. (DGLR)  
Godesberger Allee 70, D-5300 Bonn 2, F.R.G.

## EXPANDING TILT ROTOR CAPABILITIES

J. M. Drees  
Bell Helicopter Textron Inc.

### ABSTRACT

Bell's successful tilt rotor aircraft, the XV-15, is the culmination of over 50 years of research, development, and testing. It has proven the practicality of the tilt rotor concept and led directly to implementation of the V-22 Osprey program. The time has now come to project the full potential of the tilt rotor in the future. In this paper, possibilities for weight reductions and performance improvements are discussed that could lead to significant enhancements in payload and operational speeds. In particular, control system configurations, wing download reductions, wing forward sweep, and canard concepts are suggested as candidates offering potential improvements for the next generation of tilt rotor aircraft. To achieve forward velocities beyond what is feasible with the tilt rotor, its derivative, the tilt fold rotor, could become attractive for high transonic and perhaps supersonic performance, provided that suitable convertible engines become available.

### 1. INTRODUCTION

The concept of the tilt rotor has been with us for quite some time. Many early patents testify to this. For example, an interesting tilt rotor patent was filed in 1933 (see Figure 1 and Ref. 1) in which the tilting pylons at the end of the wing were equipped with stabilizing fins and wheels. The first full-scale tilt rotor aircraft was built by the Transcendental Aircraft Company (Figure 1). The Transcendental Model 1-G Convertiplane was reported to have achieved a forward speed of 115 mph in helicopter mode and a rotor tilt angle of 35° forward (Ref. 2). One of its designers, the late Robert L. Lichten, joined Bell in 1948, where he directed the design, construction, and testing of the XV-3 tilt rotor under an Army-Air Force contract. This aircraft demonstrated the full conversion process for the first time by tilting the rotors 90° forward. A maximum speed in the converted mode of 118 knots was reached. Subsequent testing by Bell and Army pilots revealed that some aeroelastic and aircraft stability problems had to be solved before tilt rotor aircraft could be designed to reach their full potential.

Through an intensive in-house research effort by Bell and full-scale testing of the XV-3 by NASA in the 40- by 80-foot Ames wind tunnel during the 1960's, stability solutions for the tilt rotor were found. This opened the door for the development and construction of two XV-15 research aircraft by Bell under a NASA-Army-Navy contract. These aircraft, which are still being used for development work, have reached speeds of 301 knots in level flight at 16,500 feet and 345 knots in dives. The aircraft attracted widespread attention through demonstrations and many operational tests, setting the stage for the next development, the Bell-Boeing V-22 Osprey program.

The Osprey program, under contract to the U.S. Navy, calls for the building of six full-scale development, 40,000-pound tilt rotor aircraft. The first flight, expected in 1988, will be a milestone of major proportions in view of the half century that has been required for maturing of the tilt rotor concept.

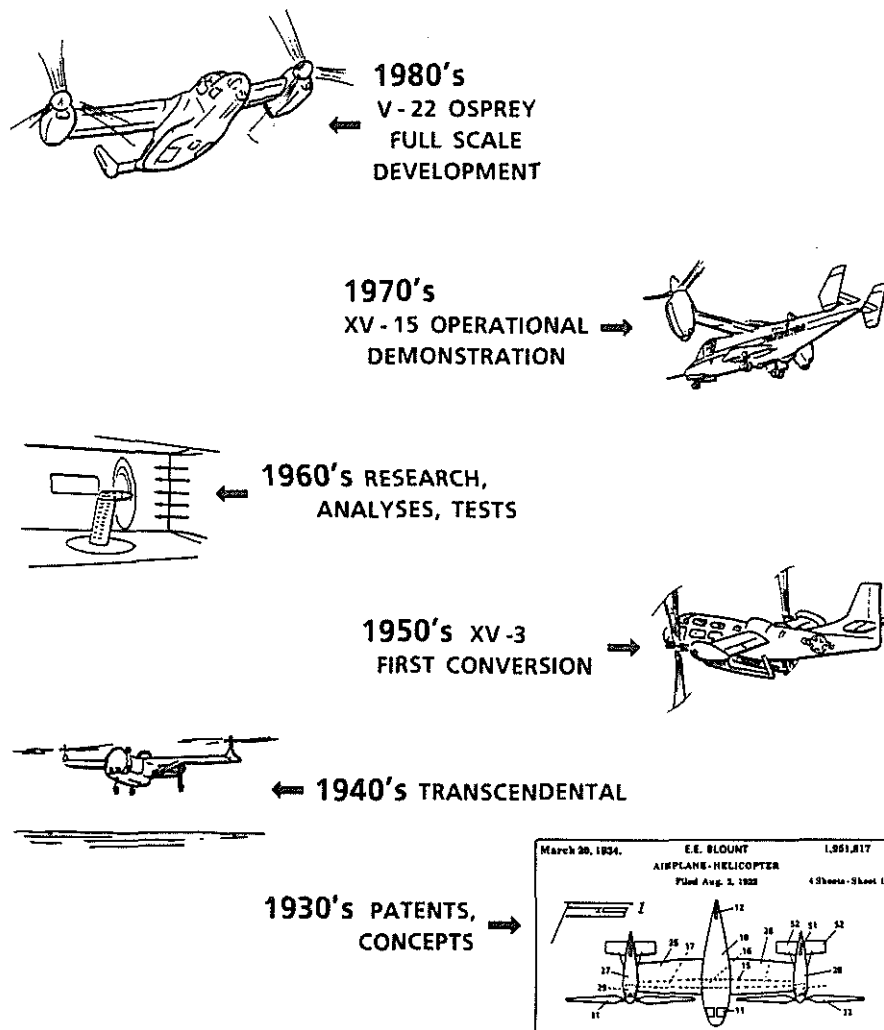

Figure 1. Major milestones in tilt rotor development.

The V-22 is by no means an ordinary tilt rotor aircraft. It will be the first all-composite rotorcraft to reach production and features sophisticated fly-by-wire controls. Automatic folding of the rotor blades and a pivoting wing permit shipboard operation and storage. It will truly combine all the advantages of fixed-wing turboprop aircraft with the low-speed capabilities of the helicopter at twice the speed, range, and altitude performance of the latter (Figure 2).

The question to be raised here is, Have we reached the end of the development line for the tilt rotor? The answer, emphatically, is "no." So far, all efforts have been directed towards making the concept work so the step to production can be taken with confidence. Very little has been done in the way of configuration refinement. Fixed-wing aircraft have not exhausted their potential, nor has the helicopter, as the many new projects now on the drawing board testify. The tilt rotor, as a newcomer in the field, has not even begun to explore all its possibilities.

Based on today's knowledge and probable technology development, it is possible to project the potential improvement in payload capability, cruise efficiency, and speed.

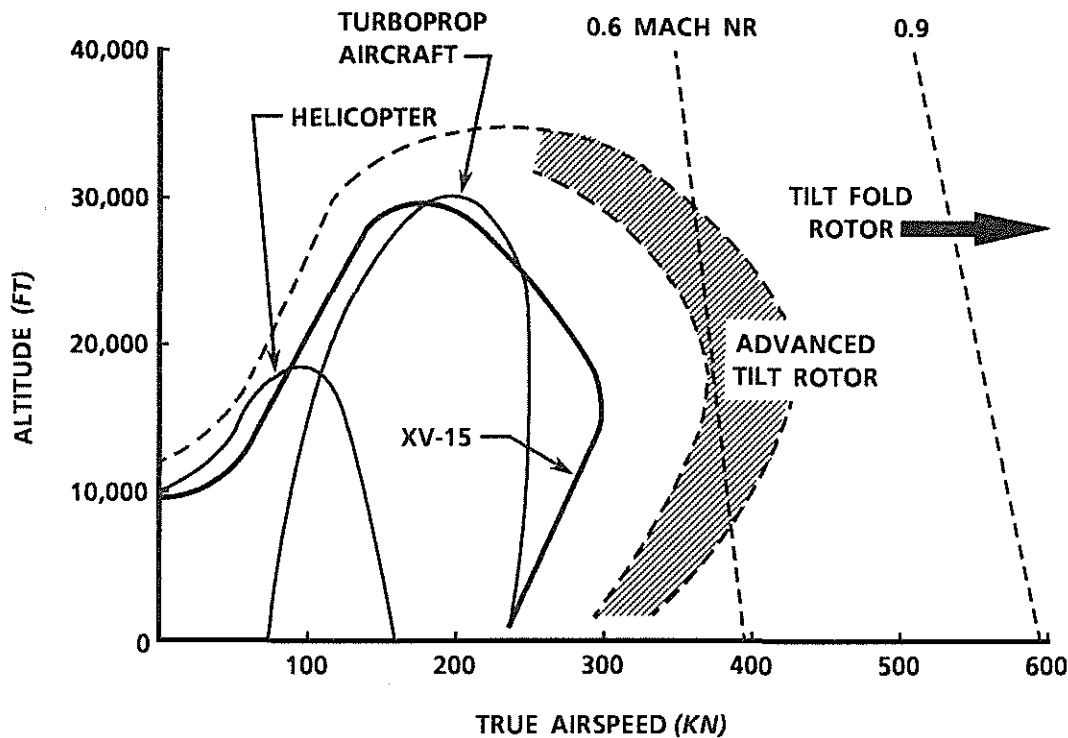

Figure 2. The flight envelope of the tilt rotor combines that of the helicopter and the turboprop aircraft. Expectations of what can be achieved in the future are indicated.

## 2. PAYLOAD INCREASE

### 2.1 Weight Reductions

The empty weight over gross weight fraction of a tilt rotor is higher than that of a helicopter. Typically, the ratio is 0.55 for a modern helicopter design and 10% to 20% higher for a tilt rotor aircraft (Ref. 2). This is to be expected because of its added wing and tilt mechanism. The fact that it has two rotors and transmissions does not cause additional weight because helicopters also have two rotors and transmissions to drive them (a main and tail rotor or two rotors in tandem).

Composite materials can save structural weight on the order of 20% to 25% relative to a metal airplane, as proven by the Army's Advanced Composite Aircraft Program (ACAP). Further weight reductions should be possible once more is known about composite structures - in particular, how to reduce the influence of environmental factors, the sensitivity to impact loads, and interlaminar shear.

As pointed out in the introduction, the V-22 already incorporates an all-composite airframe and thus has already taken advantage of some of the weight savings that one may expect to achieve for advanced tilt rotor aircraft. In addition, the use of a fly-by-wire control system saves weight, which is understandable in view of the complexities and long control routes for a tilt rotor mechanical control system.

An important aspect of the tilt rotor is the fact that it essentially has two control systems: in the hover mode, control is achieved through cyclic and

collective pitch control of the rotor blades; in the converted high-speed mode, control is switched to the rudder, elevator, and ailerons - the standard fixed-wing controls - although the collective blade control remains active. In the airplane mode, cyclic pitch is no longer used but the swashplate mechanism for cyclic pitch control is still in place.

Would it be possible to control the high-speed mode with the already available rotor controls used in the helicopter mode? This, of course, would eliminate the rudder and elevator and reduce aileron controls, thus saving weight and reducing complexity. The means for accomplishing this could be as follows:

- a. Roll control could be enhanced by differential longitudinal cyclic pitch. The thrust component and the rotor in-plane forces would create the rolling moment.
- b. Yaw control could be achieved by differential rotor thrust produced by differential collective pitch. As a result, however, the rotor mast torque to the counter-rotating rotors would no longer be equal and opposite, thus causing a rolling moment on the fuselage in the direction of rotation of the rotor with the reduced thrust. This moment can be compensated for by the cyclic roll control described in item a above.
- c. Pitch control could simply be done by cyclic fore-and-aft swashplate control. Both the rotor forces and the flapping moment (if a hubspring were used, as in the XV-15, or from a bearingless rotor with high hinge offset) contribute to the pitching moment on the fuselage.
- d. Rather than using cyclic pitch to tilt the rotors, as discussed in items a and c, it is also possible to use the pylon tilt mechanism. This may require more powerful, faster moving actuation and might cause undesirable wear of the tilt actuator. Yet it could become necessary to use pylon tilt in conjunction with swashplate control in order to keep rotor flapping within acceptable limits.

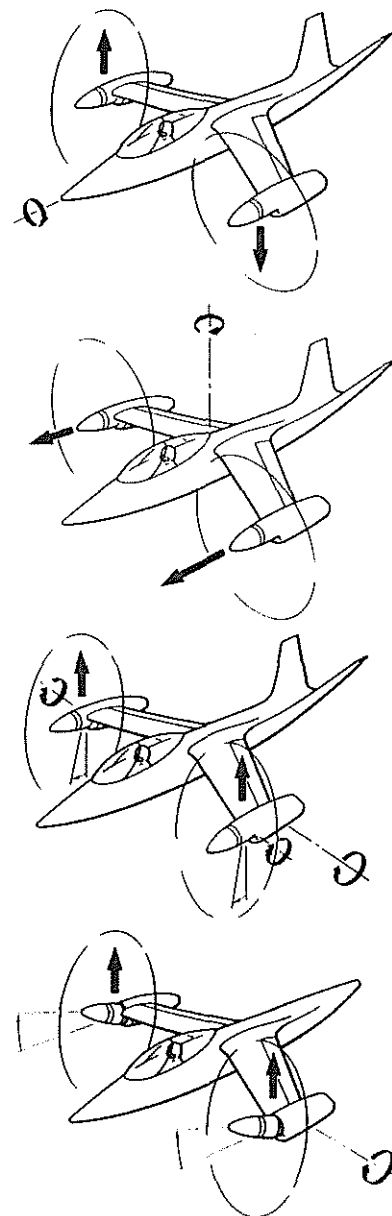

The idea of using the rotors for control in both the helicopter mode and the converted mode was proposed by R. Hafner many years ago. He actually took the concept one step further by not only eliminating the control surfaces, but also reducing the size of the fin and elevators, or even eliminating them. This makes good sense since a highly statically stable fuselage would require large rotor forces and moments to affect pitch, yaw, and roll. A statically unstable fuselage takes only small rotor control inputs. While the concept of control configured aircraft at the time was unheard of, it is seriously being explored at present by the fixed-wing industry (such as in Grumman's X-29 research

aircraft). The idea of a statically unstable aircraft is really not new to the helicopter industry. We are and have been flying unstable aircraft for years, often requiring dual electronic stabilization systems for IFR operation. To apply the concept in the high-speed mode of a tilt rotor aircraft requires a highly redundant fly-by-wire control system, a technology that is already developed and available.

It would be a mistake to think that control of the high-speed mode by means of rotor control will be easy to achieve. The oscillatory blade loads in the high-speed flight mode increase considerably with shaft angle of attack. The rotor has to be designed either to accept high 1/rev flapping moments or to be able to minimize flapping. In addition, a very serious look at proprotor stability, in combination with the short-period stability of the entire aircraft, is required for such a concept, particularly if the airplane's stability depends entirely on electronic stabilization.

The weight reduction in a tilt rotor aircraft with an unstable fuselage and no fixed-wing control surfaces is quite large. On a production version of the XV-15 with mechanical controls, this could amount to a weight reduction of 1.44% of the gross weight.

In summary, the estimated weight reductions possible for a future tilt rotor, in comparison with today's tilt rotor (like the all-composite Osprey), are as shown in Table 1.

**TABLE 1. POSSIBLE WEIGHT REDUCTIONS**

	Percentage of Empty Weight over Today's All-Composite Aircraft
Advanced composite technology	4.0
Elimination of rudder, elevator, and aileron fly-by-wire controls	0.4
Reduced tail volume	<u>1.2</u>
Total	5.6

## **2.2 Improved Hover Efficiency**

The hover figure-of-merit of the tilt rotors, as measured on full-scale rotors, is well over 80%. This is more than 5% higher than for comparable contemporary helicopter rotors. This improvement (see Figure 3) is attributed to higher blade twist (40° vs. 10°) and higher disc loading (10-15 vs. 7-10).

While additional improvements on the order of 2% to 3% may still be possible by refining airfoils and applying special swept tips, it will not be easy to improve the hover aerodynamic efficiency of the rotor itself much beyond this.

In contrast to most common helicopters, overall hover efficiency of the tilt rotor benefits from the absence of a tail rotor. This amounts to about a 10% improvement that could be realized if there were not an offsetting wing download of about 10%. By comparison, most helicopters exhibit a fuselage download in hover of about 3% on top of their 10% tail rotor loss.

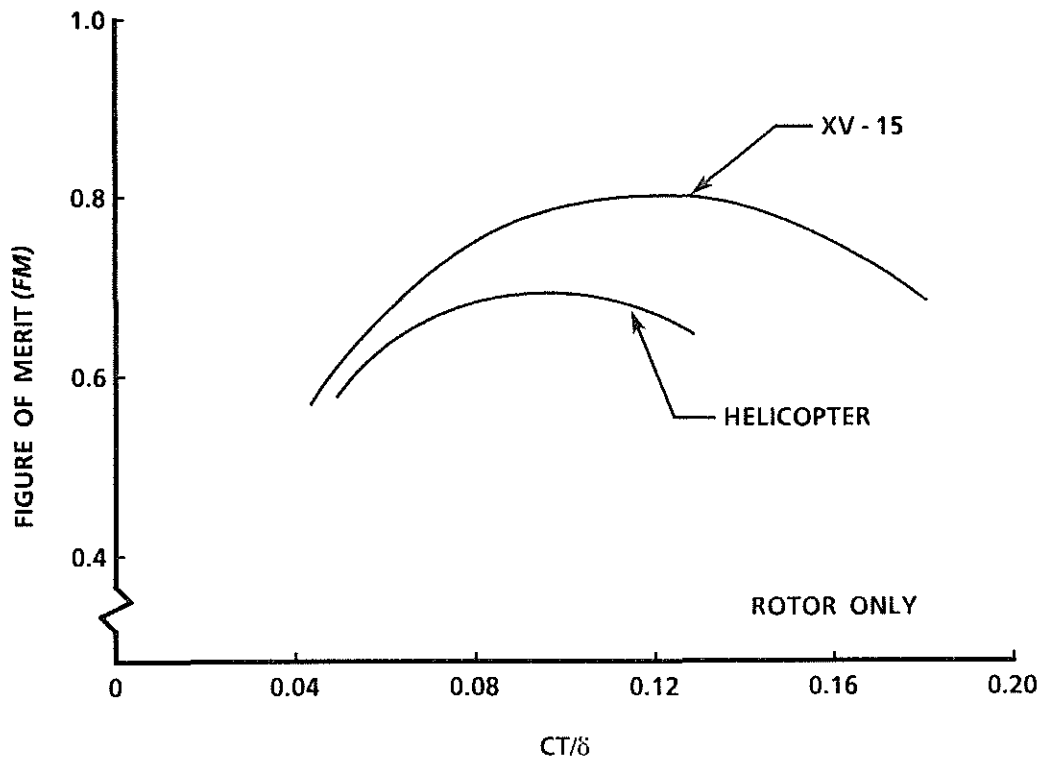

Figure 3. Comparison of hovering figure-of-merit for tilt rotor and helicopter rotor.

In comparing these three factors (figure-of-merit, tail rotor, and download) for the tilt rotor and the helicopter, it is seen that the performance difference, in terms of pounds of rotor thrust that one horsepower can lift (Figure 4), between the typical helicopter with a disc loading (DL) of 7 and the tilt rotor with a DL of 12 tends to disappear. If we could find a way to obtain a large reduction in wing download, the tilt rotor would come out ahead. Is it possible to improve the hover efficiency of the tilt rotor by 6% to 8% by reducing the wing download? The answer is "perhaps."

The hover performance of the XV-15 tilt rotor wing has already been increased by about 6% (Ref. 4) by lowering a full-span flap (Figure 5). This reduces the flatplate area of the wing planform that the downwash sees from length A to B. The flow under the wing is completely stalled. Lowering the flaps beyond 60° usually does not help because of stalled flow on the upper side of the flaps.

The NASA study by McCroskey et al. (Ref. 4) indicates that a careful flap design can improve the flow somewhat. More intriguing is that potential flow theory (Figure 6) teaches that, without viscosity, the flow around an elliptical cylinder will not have stalled flow and, consequently, will have no drag. The dynamic pressure on the bottom is then equal and opposite to the dynamic pressure on the top. If we could force the flow to resemble the potential flow pattern, it should be possible to drastically reduce the wing download.

A NASA investigation by Felker et al. to reduce the wing download resulted in a download reduction of 25% due to leading edge and trailing edge blowing at high rotor thrust coefficients (Ref. 5). Other important effects noted were a reduction of about 10% if the rotor blades went forward over the wing (reversed from the XV-15) and a reduction of 30% due to deflecting the wing flaps 60°.

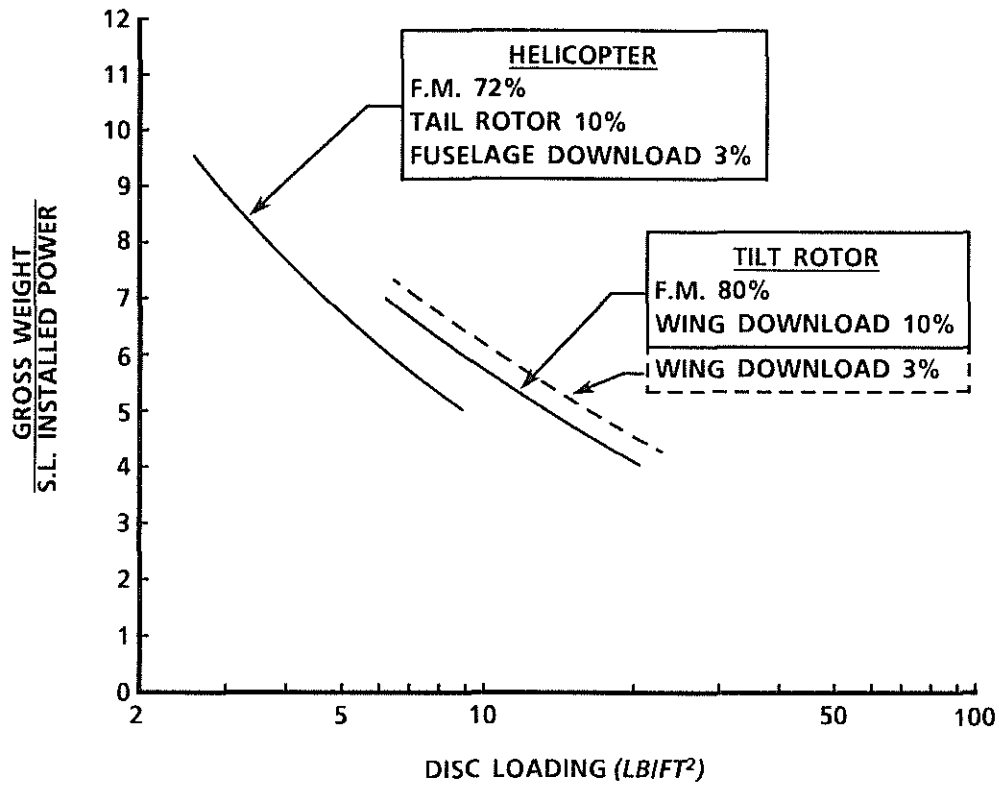

Figure 4. Effect of disc loading on lift efficiency to hover at 6000 ft/95°F.

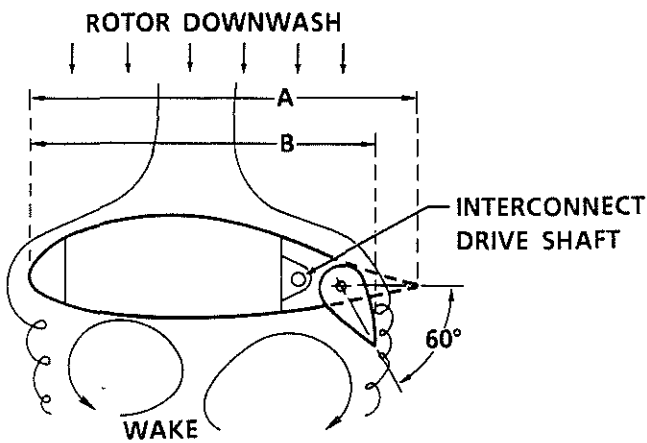

Figure 5. Lowering the wing flaps reduces the wing download.

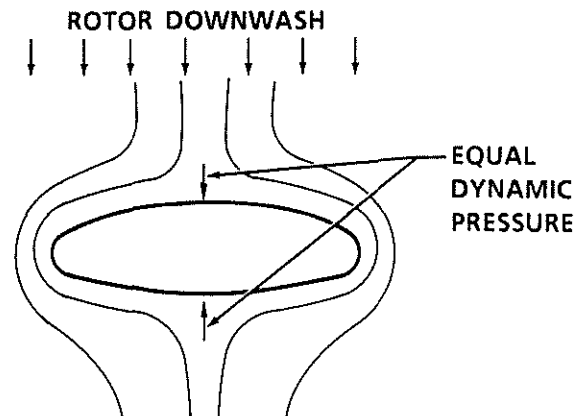

Figure 6. Potential flow: no stall, no download.



In a parallel effort, Bell investigated the possibility of using the already existing interconnect drive shaft as a rotating cylinder to energize the flow around the trailing edge (Figure 7). A leading edge slat with and without blowing around the leading edge was also tested in conjunction with the rotating cylinder (Figure 8). Initial results showed download reductions of about 25% in comparison with the 30% chord flap set at 67° and the cylinder stopped.

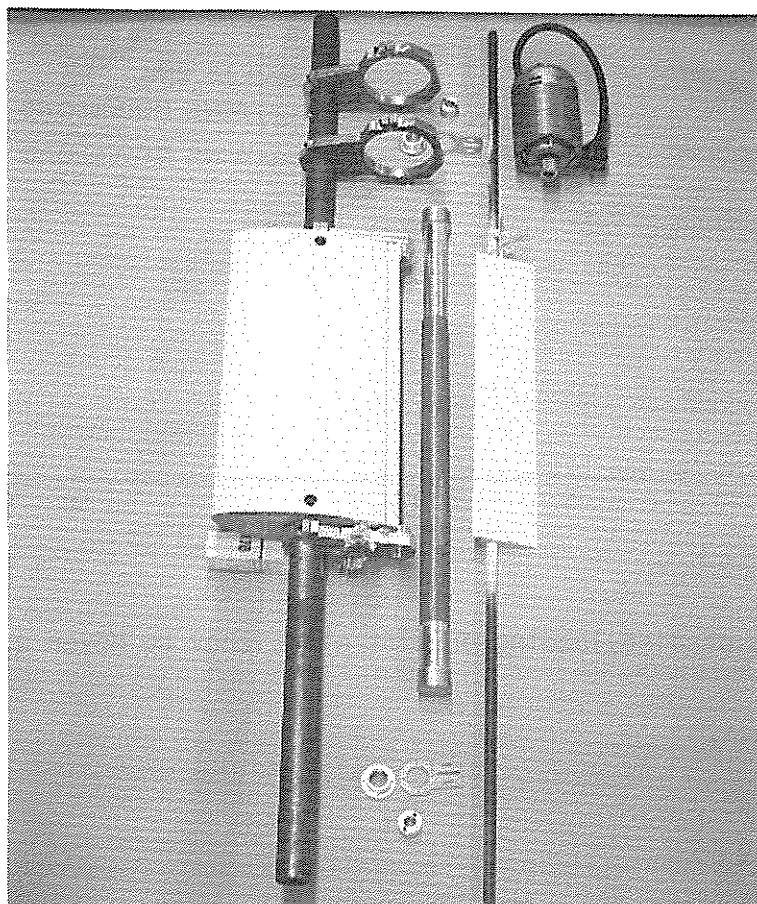

Figure 7. Components of the wing model with the rotating cylinder surface pressure measurements were used to determine the hover download and lift in forward flight.

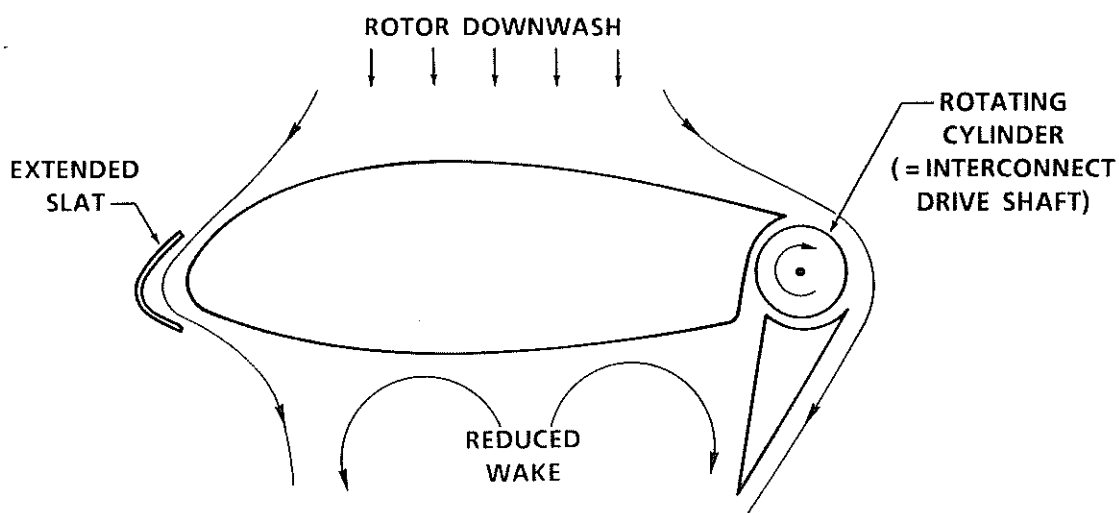

Figure 8. Wing cross section and flow pattern of installation tested.

It should be pointed out that by using a rotating cylinder with a flap setting at an intermediate position, very high aircraft  $CL_{max}$  values of 8 can be realized. This was shown by NASA's full-scale test of a similar concept on a YOY-10 aircraft (Ref. 6). Similarly, the low-speed maneuver capability of the tilt rotor aircraft will be greatly enhanced also. It should be noted that the weight penalty for the rotating cylinder concept is minimized since the interconnect drive shaft is already accounting for most of the weight.

In summarizing this section, one can expect to see a future improvement in hover efficiency of 2% through the use of advanced airfoils and blade tips, and 5% to 7% improvement as a result of wing download reduction. A total of nearly 10% improvement does not seem to be out of the question.

A 10% performance gain, combined with the weight reduction discussed previously, will translate into a payload increase of more than two times these values. If, in addition, the mission fuel weight can be reduced, we would see even further payload improvement. This will be explored next.

### 3. INCREASING CRUISE EFFICIENCY AND SPEED

#### 3.1. Moderate Transonic Operation

In comparison with the helicopter, the tilt rotor high-speed efficiency is far superior, based on analysis of the overall aircraft L/D values (Figure 9). As a result, the cruise speed is higher by 80 to 100 knots and the maximum speed is almost doubled. The reason for this is obvious: the edgewise operation of a helicopter rotor is limited by the advancing tip Mach number and retreating blade stall. In addition, it is difficult to streamline the helicopter hub and control system. The converted tilt rotor operates like an efficient turboprop aircraft. By slowing down rotor rpm, additional propulsive efficiency is realized. Unlike the helicopter, the tilt rotor aircraft likes to operate at high altitudes to further improve its operational efficiency.

Tip-mounted rotors, when turning in the opposite direction to the wing tip vortex, contribute to increasing the lift efficiency of the wing because of the proprotor swirl (Figure 10). The proprotors on the XV-15, which turn in this direction, cause a swirl upwash on the wing nearly equal but opposite to the induced wing downwash. Interestingly, the rotor should rotate in the opposite sense for hover wing download reduction, as discussed previously. More research is needed.

To reach speeds higher than achieved thus far with the XV-15 (maximum of almost 350 knots in a dive), a number of design constraints must be dealt with. In the first place, blade twist will have to be adjusted for the higher advance ratios, while the rotor tip speed will reach higher Mach numbers. Advanced super-critical tip airfoils and swept blade tips can be used to delay the influence of compressibility drag rise at the blade tips (Figure 11). Lowering the rpm at high speed is very important, but may be limited by engine characteristics (unless a two-stage transmission is used, as was done in the XV-3 tilt rotor), and by low-rpm flapping and rotor oscillatory loads as well.

The next barrier to overcome is caused by the thickness of the wing. Above its maximum speed, the 23% wing of the XV-15 will begin to cause a compressibility drag rise, especially when flying at high altitudes. A thick wing was chosen to provide adequate torsional rigidity and to meet strength requirements in jump takeoff maneuvers. While making the wing thinner is an option, it may cause undesirable weight penalties. An alternative is to sweep the wing. The wing of

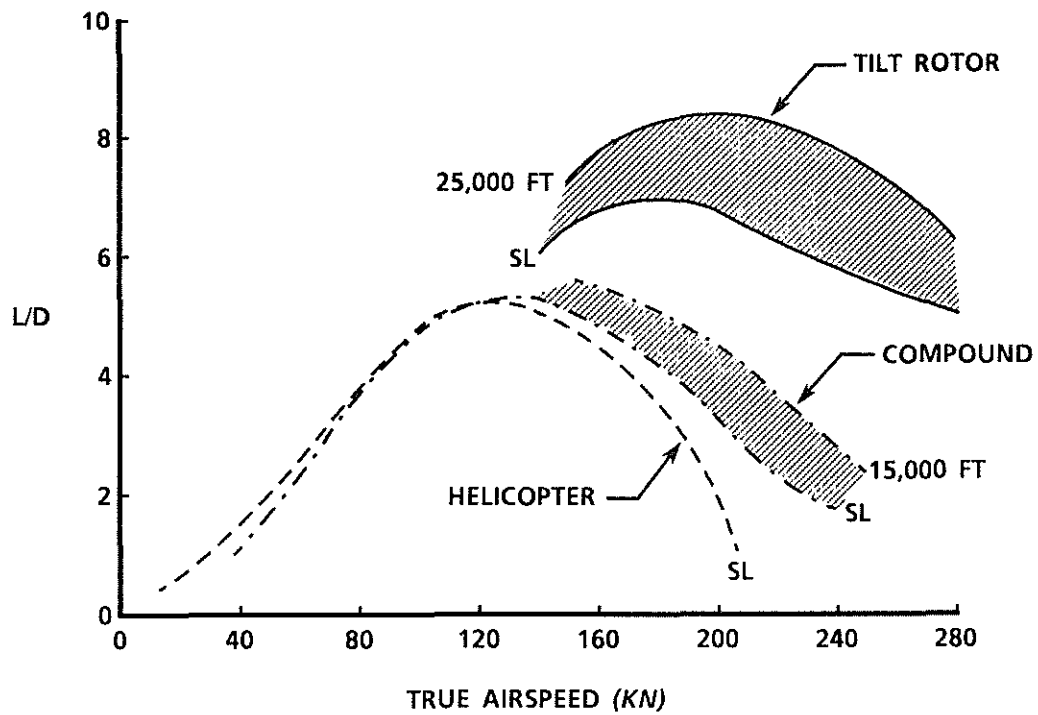

Figure 9. Overall lift over drag ratios based on power required as a function of forward speed for aircraft in the 10,000-pound weight class.

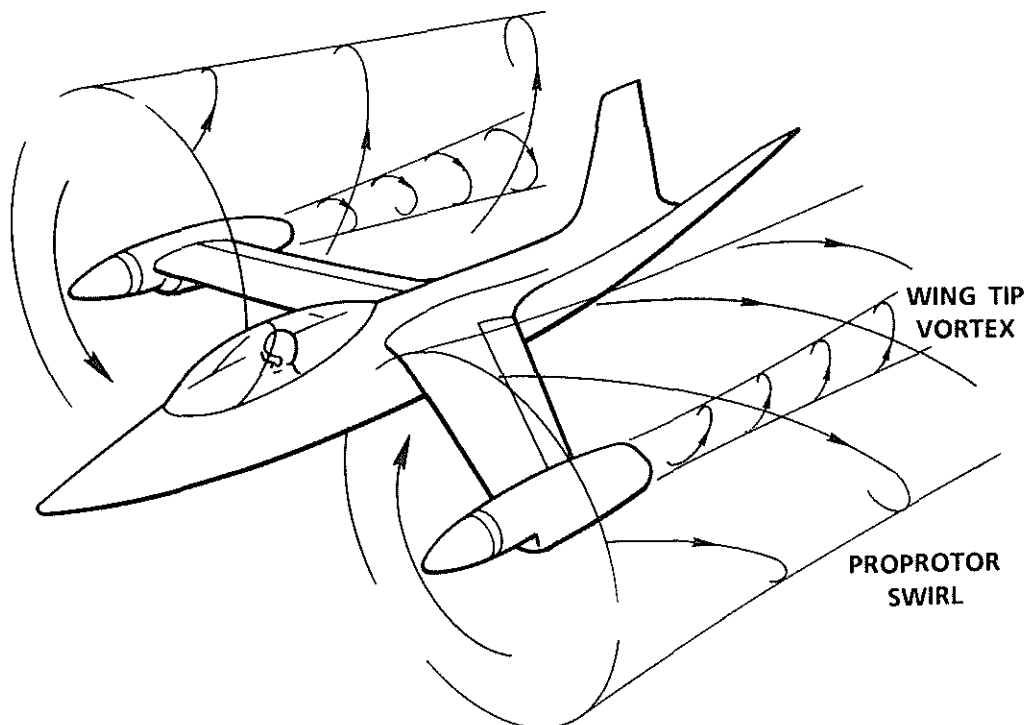

Figure 10. Proprotor swirl opposes the wing tip vortex flow field, thus reducing the induced wing downwash and induced power.

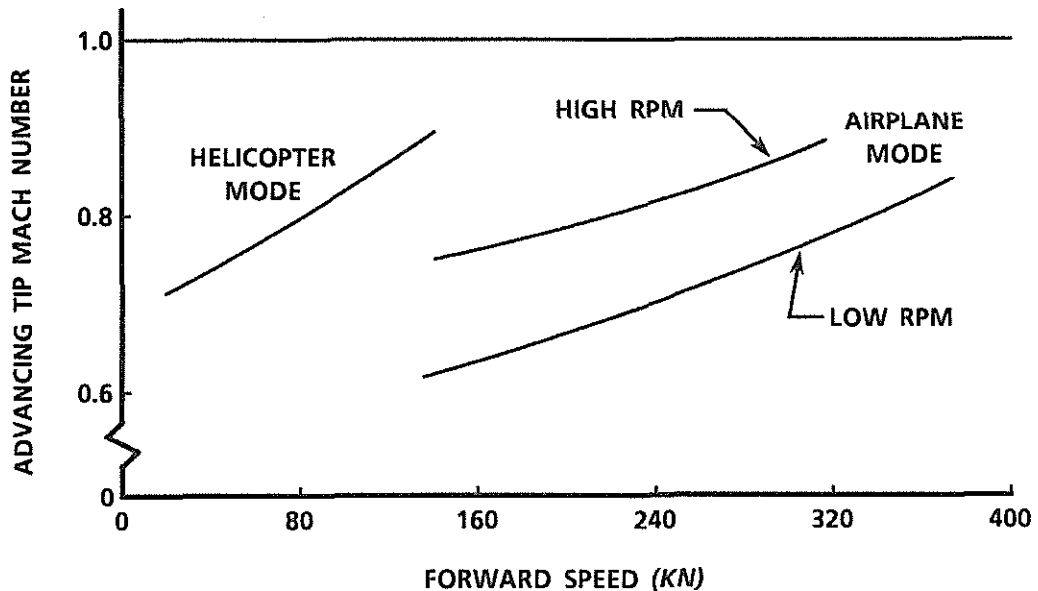

Figure 11. Blade tip Mach numbers vs. speed.

the XV-15 is already swept forward by  $6.5^\circ$  to provide increased rotor flapping freedom. The amount of sweep, however, is not enough to affect the critical Mach number significantly. A study was done to investigate the effect of a very large increase in forward sweep (Figure 12). This led to the following results:

- a. Aerodynamically, the critical wing Mach number is increased noticeably (from  $M \approx 0.65$  at  $0^\circ$  sweep to  $M \approx 0.75$  at  $40^\circ$  forward sweep). The reason for this improvement is obvious from the distribution of the cross-sectional area of the entire aircraft, as shown in Figure 12. This corresponds to about a 30-knot speed increase. Further enhancements can be achieved through some area-ruling of the fuselage and by the use of supercritical airfoil sections for the wing.
- b. The aeroelastic stability of the tilt rotor nacelle is much improved because the forward sweep reduces the rotor "overhang" relative to the torsional axis. Negative damping forces acting on the rotor have a smaller arm (a) to act upon about the torsional axis (Figure 12).

With composites in the wing structure it is possible to sweep the elastic axis of the wing even farther forward, thus reducing the overhang (a) even more. There will be a weight penalty of about 0.4% of gross weight as a result of a  $35^\circ$  forward sweep, since the length of the wing is increased. Some structural taper may be desirable.

The static divergence of the heavily forward swept wing, if made thin and flexible, would be of concern. With a thickness of over 20% and the use of graphite composites, this should not pose a problem.

- c. The heavily forward sweep raises the question of center-of-gravity location and center of lift. A canard configuration becomes a natural solution, with the added advantage of lift on the canard wing instead of the download required on normal elevators (Figure 13).
- d. A definite advantage of the canard configuration is that the heavy spar will go through the fuselage aft of the cabin area, thus enhancing the cabin volume.

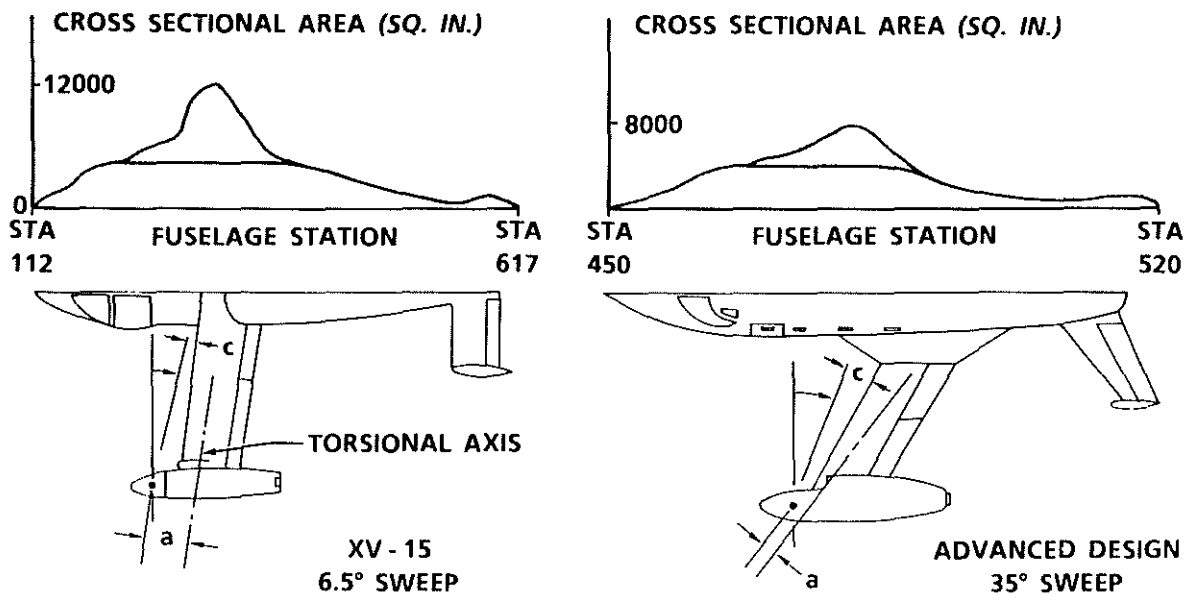

Figure 12. Effect of forward sweep on aircraft cross-sectional area, on rotor overhang (a), and on flapping clearance (c).

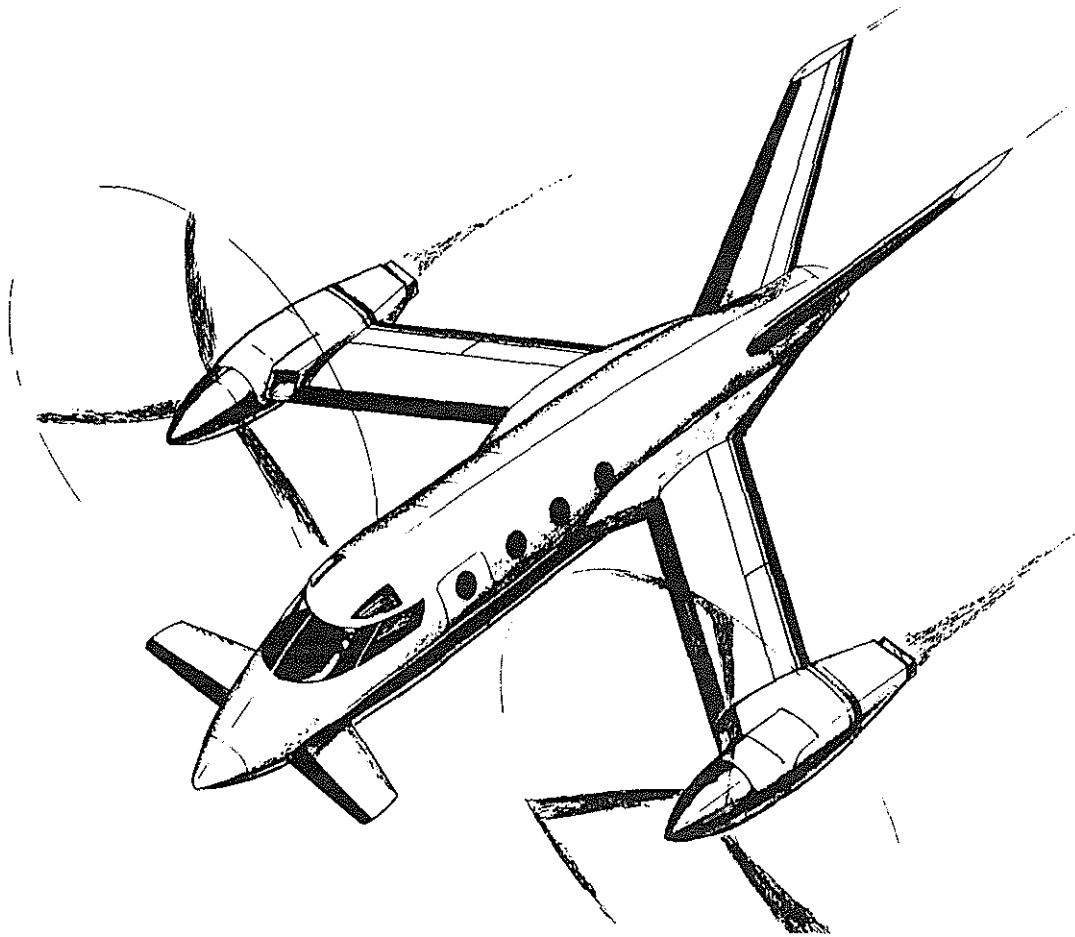

Figure 13. Canard concept of business tilt rotor aircraft.

It is estimated, based on our studies, that the cruise efficiency can be improved by 10% to 15% and that speeds well over 400 knots can be expected. Figure 2 illustrates the increase in flight envelope for future tilt rotor concepts. These possibilities are firmly based on known fixed-wing technology and can therefore be predicted with high confidence.

### 3.2. High Transonic and Supersonic Speeds

Beyond the realm of the pure tilt rotor lies the application of the tilt fold rotor. A Bell tilt fold rotor system sized for the XV-15 was tested full scale in the NASA-AMES 40- by 80-foot wind tunnel in 1972 (Figure 14). With a modified XV-15 rotor, tests proved the feasibility of stopping the rotor by feathering, followed by indexing and folding the blades backwards. No fundamental problems were reported. The process was reversed by unfolding the rotor and bringing it back up to normal rpm. This was done at speeds up to 175 knots and angles of attack representing 1.5g maneuvers. In addition, numerous scale models were tested by Bell and by Boeing-Vertol confirming the feasibility of the concept.

The concept is practical only if the same engines can be used in the tilt rotor mode as in the tilt fold mode where jet propulsion is required to take over the function of rotor thrust. This requires a convertible engine such as that described by Eisenberg et al. in Reference 7.



Figure 14. Bell's tilt fold rotor test in NASA's 40- by 80-foot wind tunnel.

There are several schemes for convertible engine designs, two of which are depicted in Figure 15:

- a. A fixed pitch fan with torque converters to decouple the fan when torque is applied to the rotor drive system.
- b. A variable pitch fan jet engine with a power takeoff to drive the rotor system. By increasing the pitch of the fan, power will be converted to the fan while the rotor drive torque and rpm are brought to zero.

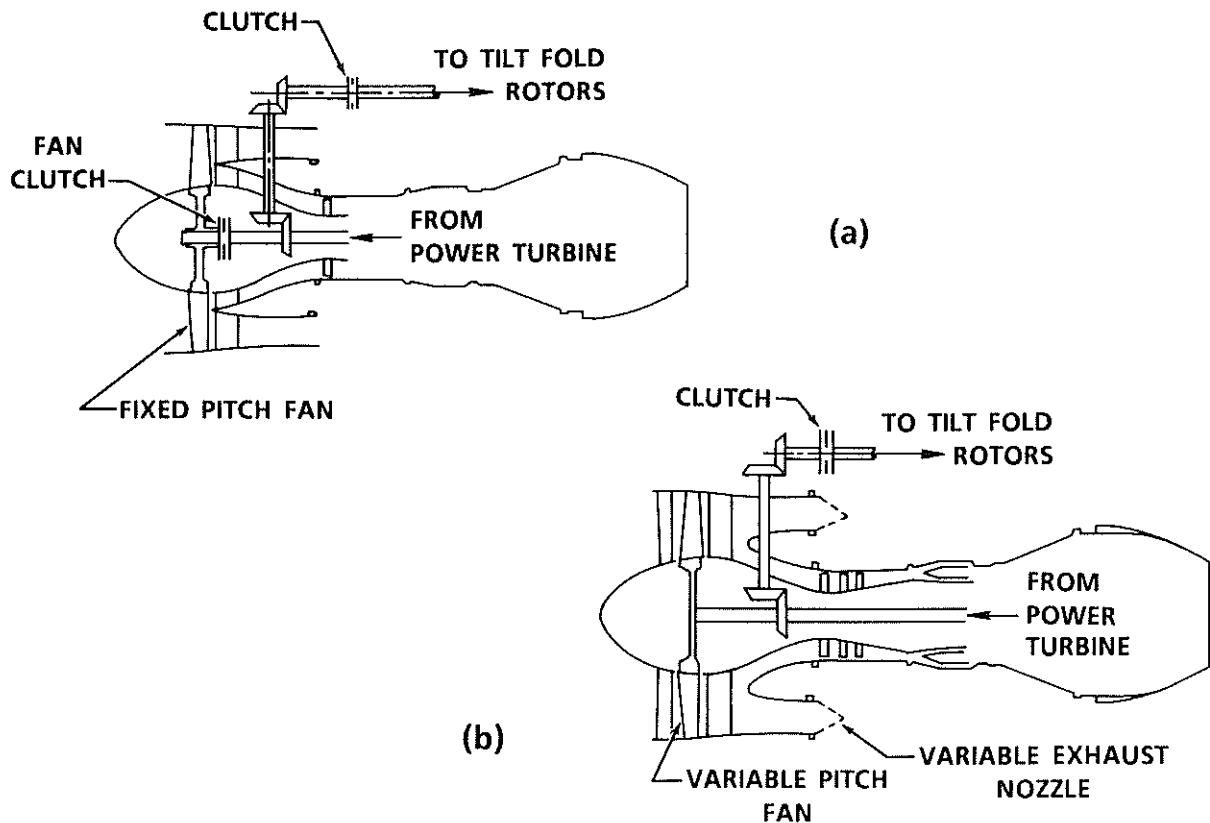

Figure 15. Two typical convertible engine concepts.

Test beds for the tilt fold rotor concepts could include the XV-15 by adding a jet engine and using the folding blades already tested in the 40- by 80-foot NASA wind tunnel. This initial test would not require a convertible engine. A total system demonstrator could use the V-22 Osprey in combination with foldable blades and the GE TF-34 CEST or the Allison PD434-7 convertible engines.

While the advantages that the tilt-fold concept offers will be significant, one may expect that practical application will be many years away. Not only must an increase in complexity (Figure 15) and weight (approximately 10% to 15% increase in gross weight) be expected, but the convertible engines used for propulsion will not be as efficient as the tilt rotor at subsonic speeds. Therefore, excess jet thrust must be available to push the aircraft to high transonic speeds (Figure 16). In principle, even supersonic speeds are possible. Special missions will be required, however, in order to generate a need for such an aircraft.

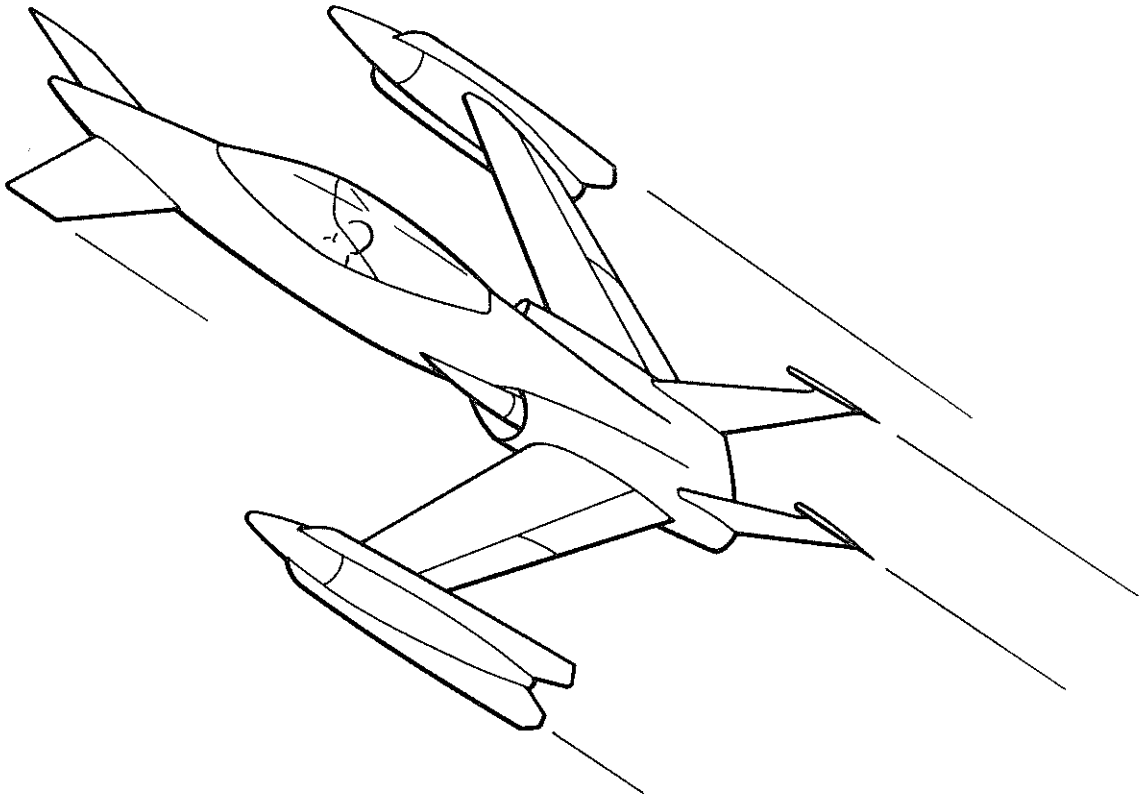

Figure 16. Concept of a transonic tilt fold rotorcraft.

#### 4. CONCLUDING REMARKS

A look into the future and projected technical advances that may be incorporated in the next generation of tilt rotor aircraft has been presented. With the first generation (Transcendental I-G, Bell XV-3) being exploratory in nature and the second generation (Bell XV-15, Bell-Boeing V-22) resulting in the first production design, one can expect the next, i.e., third generation to concentrate on refinements and increased efficiency.

It has been shown that significant weight savings are foreseen through the use of composites and simplification of the controls. The latter envisions the rotor controls used in the helicopter mode (cyclic and collection) to remain functional even in the high-speed airplane mode, thus eliminating the fixed-wing type controls now used in the high-speed airplane mode. In addition, using redundant fly-by-wire controls, a statically unstable aircraft is envisioned by reducing tail volume. This not only saves weight and reduces drag, but also reduces the control input requirements.

Hover lift efficiency improvements can be expected if the wing download can be reduced significantly. First test results indicate that boundary layer control devices can be used advantageously, but more research is required before this can be applied successfully.

An analysis of high-speed improvements suggests that an increase in the tilt rotor swirl may partly oppose the effect of the wing tip vortex strength. This would result in a reduction of induced drag. Whether this would be a significant improvement over what already is done in the XV-15 remains to be



seen. A more certain improvement in high-speed capabilities will result from improving rotor airfoils and blade tip shapes, wing sweep, and area-ruling of the airframe. Heavily forward swept wings may be advantageous for tilt rotors. Such an approach leads logically to a canard concept (Figure 13). Moderate transonic speeds should be within the capability of the next generation of tilt rotors. The forward flight performance improvements, combined with the expected payload increases, could result in a substantial productivity improvement (about a factor 3).

Finally, beyond or parallel to the third-generation tilt rotors awaits the tilt-fold rotor. Its feasibility was proven years ago through NASA-Bell full-scale wind tunnel tests. It is suggested that this concept be tried in flight. For instance, an XV-15 could be modified by adding auxiliary jets and using the already wind-tunnel-tested rotors. For more advanced experiments, the V-22 with convertible engines would serve as a suitable testbed. Ultimately, transonic and perhaps supersonic speeds are attainable by tilt-fold aircraft.

The timeframe in which to expect realization of many of the advances discussed in this paper will, in all probability, have to wait until the end of this century. It behoves us, however, to step up R&D efforts to develop the concepts through analyses, wind tunnel tests, and flight testing so the next designs can incorporate the latest improvements.

The future of the tilt rotor and its derivatives will be exciting indeed.

#### REFERENCES

1. Blount, E. E. Airplane-Helicopter.  
United States Patent 1,951,817, March 20, 1934.
2. Transcendental Aircraft.  
Newsletter of the American Helicopter Society, April 1955.
3. Matthys, C. G., Scroggs, E. E. Technology Impact on Helicopter, Tiltrotor, and Tilt Fold Rotor Concepts.  
40th Forum of the American Helicopter Society, May 16-18, 1984.
4. McCroskey, W. J., Spalart, Ph., Laub, G. H., Maisel, M. D., Maskew, B. Airloads on Bluff Bodies, with Application to the Rotor-Induced Downloads on Tilt-Rotor Aircraft.  
NASA T.M. 84401, AVRADCOM T.R. 83-A-12, Sept 1983.
5. Felker, F. F., Light, J. S. Rotor/Wing Aerodynamic Interactions in Hover.  
42nd Forum of the American Helicopter Society, 2-4 June 1986.
6. Cichy, D. R., Harris, J. W., Mackay, J. K. Flight Tests of a Rotating Cylinder Flap on a North American Rockwell YOY-10 Aircraft.  
NASA CR-2135, 1972.
7. Eisenberg, J. D., Bowles, J. V. Folding Tilt Rotor Demonstrator Feasibility Study.  
42nd Forum of the American Helicopter Society, 2-4 June 1986.