

NINETEENTH EUROPEAN ROTORCRAFT FORUM

PAPER NO. C21

FLIGHT RESEARCH ON REDUCING HELICOPTER PARASITE-DRAG

by

A. AKIMOV and U. VOZHDAEV  
FLIGHT RESEARCH INST. u TsAGI, RUSSIA

SEPTEMBER 14-16, 1993  
CERNOBBIO  
(COMO) ITALY

ASSOCIAZIONE INDUSTRIE AEROSPAZIALI  
ASSOCIAZIONE ITALIANA DI AERONAUTICA ED ASTRONAUTICA



FLIGHT RESEARCH ON REDUCING HELICOPTER  
PARASITE-DRAG

A.Akimov, U.Vozhdaev

The problem on reducing airframe parasite-drag is urgent for the purpose to improve performances and to increase the capacity and fuel effectiveness of the modern high-speed helicopters.

The wind-tunnel investigations using the medium weight helicopter model have shown that by means of the external fuselage shape optimization in the area of freight hold doors, exhaust pipes, swashplate fairing and other components the helicopter parasite-drag may be considerably reduced. It is known that the results obtained on the wind-tunnel models and on the full-scale objects may essentially differ. Therefore to evaluate the effectiveness of the measures on reducing helicopter parasite-drag developed according to the wind-tunnel test results it is important to obtain the comparative data on the real objects during flight.

The following constructive measures on changing Mi-8 helicopter fuselage shape were designed to evaluate the possibilities of helicopter parasite-drag reducing (Fig.1):

- The outer fuel tanks are removed;
- The fairings are installed in front of and behind the exhaust pipes;
- The freight hold doors of the fuselage rear are changed by the fairing of greater ratio;
- The swashplate fairing is installed;
- The aerodynamic improvement of fuselage surface is performed: the installation of fairings on the projecting units; the smoothing of projecting parts of glasing, doors, rivet seams etc.

The technique to determine during flight tests the variations of helicopter equivalent parasite plate surface when realizing consecutively these measures in order mentioned above.

The variation  $\sum C_x S$  for two comparable versions provided the constancy of airborne weight and rotor speed is:

$$\delta(\sum C_x S) = \frac{75 \delta N_{np} \xi}{\rho_0 V_{npub}^3 / 2}$$

where

$$N_{np} = N \frac{\rho_0}{\rho_H} \sqrt{\frac{T_0}{T_H}}, \quad V_{npub} = V \sqrt{\frac{T_0}{T_H}}$$

$\xi$

- power utilization factor determined according to the test data.

The parameter  $\delta N_{np}$  for turbine-engined helicopter is expressed by formular:

$$\delta N_{np} = \frac{\partial N_{np}}{\partial Q_{np}} \delta Q_{np}$$

where  $\delta Q_{np}$  - the variation of the helicopter standard fuel consumption per hour required in horizontal flight when performing a transition from one version to another.

$\frac{\partial N_{np}}{\partial Q_{np}}$  - the gradient of the engine power variation when changing the fuel consumption per hour which was determined according to the test data.

Then for  $\delta(\sum C_x S)$  we have:

$$\delta(\sum C_x S) = \frac{75 \xi}{\rho_0 V_{npub}^3 / 2} \cdot \frac{\partial N_{np}}{\partial Q_{np}} \delta Q_{np}$$

From this relationship it is clear that for  $\delta(\sum C_x S)$  determination it is necessary to determine the variation of fuel consumption per hour in horizontal flight for two comparable versions.

The computation accuracy of  $\delta(\Sigma C_x S)$  depends on the accuracy of  $\delta Q_{np}$  determination.

The  $\delta Q_{np}$  difference will increase according to the cubic parabola while increasing the flight speed. Therefore when increasing the flight speed the relative error of  $\delta Q_{np}$  difference determination and consequently the parameter  $\delta(\Sigma C_x S)$  will be considerably decreased. To improve the  $\delta(\Sigma C_x S)$  determination accuracy the limitation of Mi-8 helicopter maximum flight speed was increased from 250 till 300 km/h. The helicopter standard fuel consumption per hour - flight speed relationships for different versions of fuselage shape change are determined according to the flight test data (Fig.2,3 and 4).

To compute  $\delta(\Sigma C_x S)$  the determination of  $\delta Q_{np}$  difference was performed at the speeds more than 200 km/h. At the lesser speeds the difference is small and close to the spread of test points. The  $\delta(\Sigma C_x S)$  values calculated for the different versions of external fuselage shape according to the fuel consumption per hour - flight speed relations are shown on the Fig.5. It can be seen that the constructive measures being realized are very effective for helicopter parasite-drag reducing. The outer fuel tanks removal makes it possible to reduce the equivalent parasite plate by  $0,65 \text{ m}^2$ . The installation of fairings on engine exhaust pipes provides  $\delta(\Sigma C_x S)$  reducing approximately by  $0,1 \text{ m}^2$ . The freight hold doors change by the tail cone with the special profile made it possible to decrease  $\Sigma C_x S$  up to  $0,95 \text{ m}^2$ . This constructive measure consists of providing the greater fuselage rear ratio from  $2l/b=1,8$  till  $2,6$  and special shaping in longitudinal plane. This fuselage rear change makes it possible to improve considerably it's flow over which becomes more smooth. The number of stall zones obtained by using the silk threads at cruise speed decreases from  $\sim 7 \text{ m}^2$

(on the initial version) till  $\sim 2,5 \text{ m}^2$  (on the modified version) (Fig.6). In case of changing the fuselage rear configuration stall zones decreasing is the main reason of reducing the parasite-drag.

The swashplate fairing installation results in increasing helicopter parasite-drag -  $\sum C_x S$  value has increased by  $0,2 \text{ m}^2$ . Due to interaction interference between the rotor and the fuselage and the rotators availability the complex flow pattern in the upper fuselage doesn't make it possible to reduce the parasite-drag simply by means of the swashplate nosing-over.

The main rotor pylon shape analysis of the helicopters of the different countries shows that because of the undisturbed air flow interference and the flow generated by rotor near the fuselage the especially careful optimization of the aerodynamic fuselage shape in this zone is required.

Marked reducing the airframe drag was achieved by means of aerodynamic improvement of the fuselage surface: the fairing installations on the small assemblies, the smoothing of the projecting units, the rivet seams and others. The  $\sum C_x S$  value is reduced by  $0,3 \text{ m}^2$ . As a result of these measures the total reduction of  $\sum C_x S$  is  $1,05 \text{ m}^2$  that forms  $\sim 33\%$  from  $C_x S = 3,2 \text{ m}^2$  (the initial version of Mi-8 helicopter). After flight research the initial version except the improvement of the external fuselage surface was recovered and the fuel consumptions were determined.

The difference in the fuel consumptions for this version confirms that because of the surface smoothing the  $\sum C_x S$  value reduction is  $0,25 \dots 0,3 \text{ m}^2$ . Reducing helicopter, parasite-drag by  $1,05 \text{ m}^2$  makes it possible to decrease the helicopter required power at  $V=150 \text{ km/h}$  by  $4,5\%$ , at  $V=200 \text{ km/h}$  by  $8\%$ , at  $V=300 \text{ km/h}$  by  $18\%$ . This provides maximum and cruise speed

increasing accordingly by 25-30 km/h and by 20 km/h. During cruising flight the fuel consumption per kilometre is reduced by 14% (Fig.7). Cruise speed increasing and fuel consumption per kilometre reducing result in increasing standard capacity by 18%.

It should be particularly noted that after the fuselage shape constructive changing the vibration level is considerably reduced, especially at the high flight speeds (Fig.8). At  $V=300$  km/h the deviations of average square vibration g-loads on the vertical axis are decreased: in the cockpit - by 40%, in the helicopter centre of mass - by 30%. This vibration reducing is evidence of decreasing the air flow disturbances affecting the helicopter fuselage. Another factor of vibrations reducing is decreasing the absolute value of the main rotor angle of attack at high speeds leading to the variable forces reducing generated by the main rotor.

From the above-stated provisions the following conclusions can be drawn:

1. The developed technique makes it possible to perform the quantitative evaluation of the constructive measures on reducing helicopter parasite-drag.during flight tests.

2. By means of providing the rational configuration of the external airframe shapes of the parasite-drag may be considerably reduced the modern high-speed helicopters and the speed performance, fuel effectiveness and capacity may be greatly improved. For example the constructive measures performed on the Mi-8 helicopter made it possible to reduce the equivalent parasite plate surface of the airframe by  $\sim 33\%$ .

3. The flow over an airframe improvement also makes it possible to reduce the vibration level.

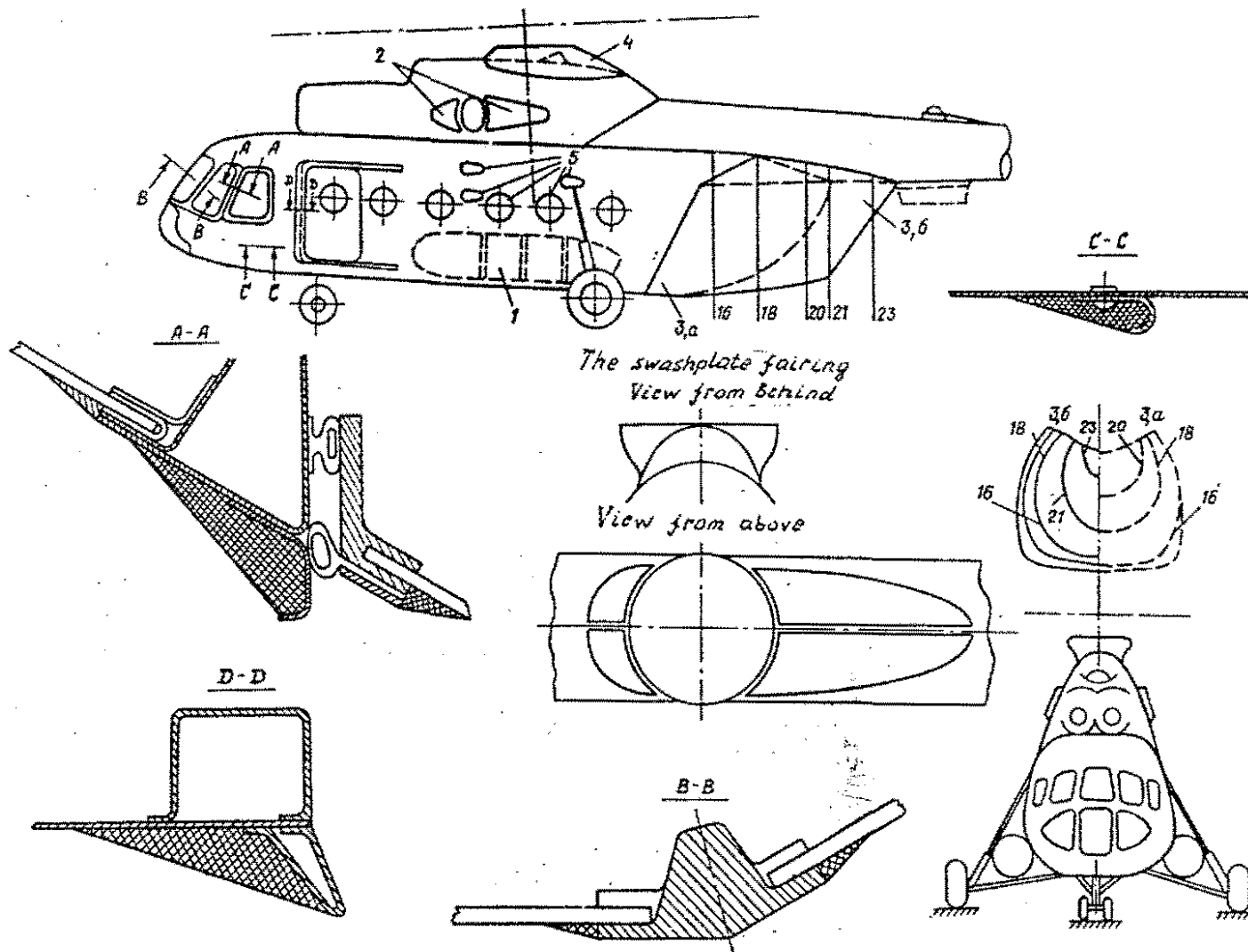

Fig.1. Change of Mi-8 helicopter airframe external lines

1 - the outer fuel tanks removal; 2-the installation of fairings on the engine exhaust pipes; 3 - the fuselage rear change; 4 - the installation of fairings on the swashplate; 5-the installation of fairings on the components and the smoothing of fuselage surface



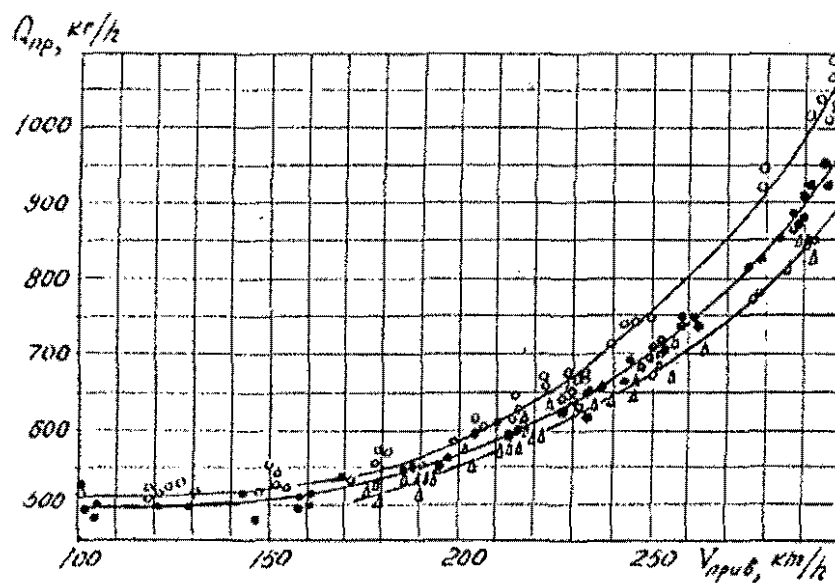

Fig.2. The standard fuel consumption per hour-flight speed relationships  $m_{np} = 9660$  kg,  $\eta_{np} = 95\%$

- - the initial version; ● - the fuel tanks are removed;
- △ - the tanks are removed; the fairings are installed on the exhaust pipes, the fuselage rear is changed.

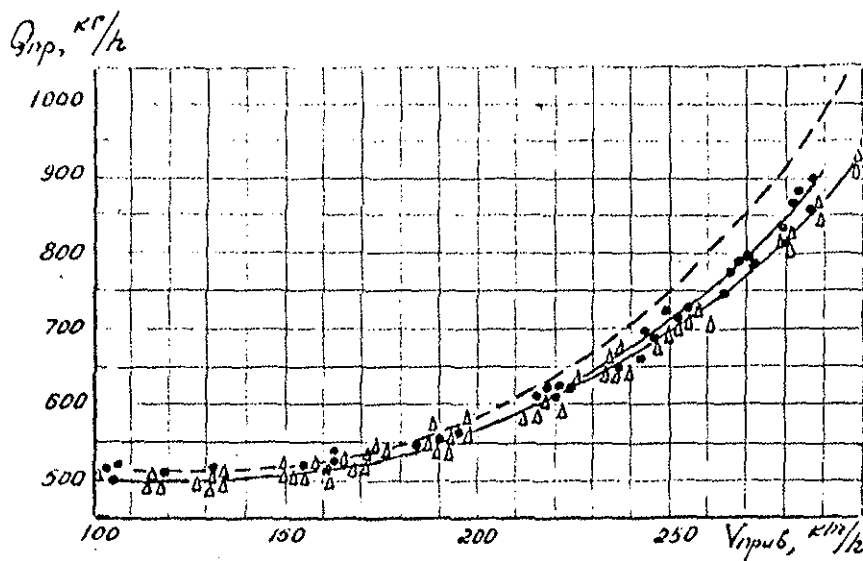

Fig. 3. The standard fuel consumption per hour-flight speed relationships  $m_{np} = 9660$  kg,  $n_{np} = 95\%$

- the initial version;
- -the fuel tanks are removed, the fairings are installed on the exhaust pipes;
- ▲ -the fuel tanks are removed, the fairings are installed, on the exhaust pipes, the fuselage rear is changed, the swashplate fairing is installed.

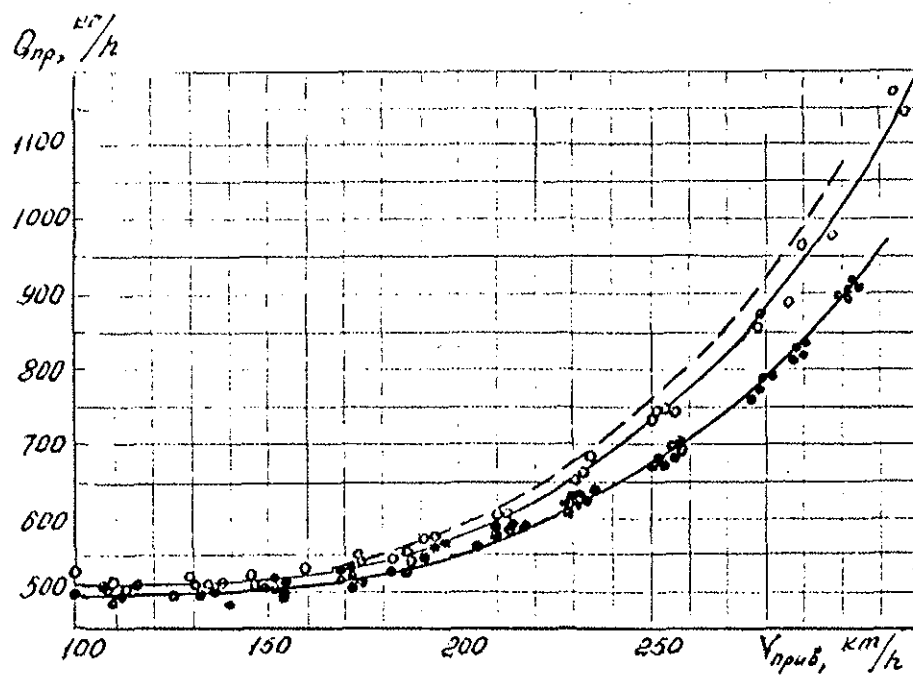

Fig. 4. The standard fuel consumption per hour-flight speed relationships

- the initial version;
- - the airframe surface is smoothen;
- - the fuel tanks are removed, the fairings are installed on the exhaust pipes, the fuselage rear is changed, the swashplate fairing is installed, the airframe surface is smoothen.

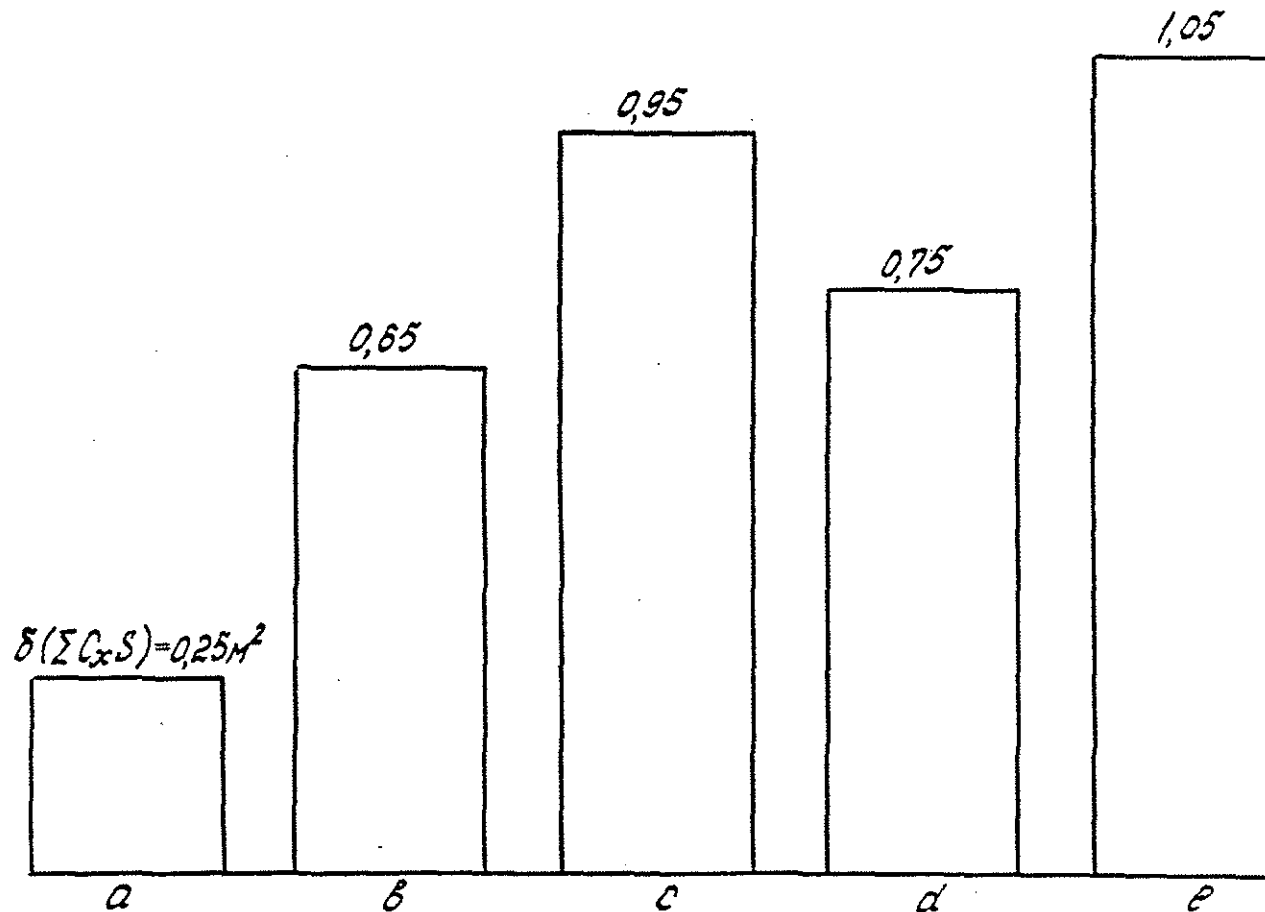

Fig.5. Reducing the equivalent parasite plate surface of Mi-8 helicopter while changing the airframe external lines,

- a - on the initial version the airframe surface is smoothen;
- b - on the initial version the outer fuel tanks are removed;
- c - on the "b" version the fairings are installed on the exhaust pipes;
- d - on the "c" version the swashplate fairing is installed;
- e - on the "d" version the airframe surface is smoothen

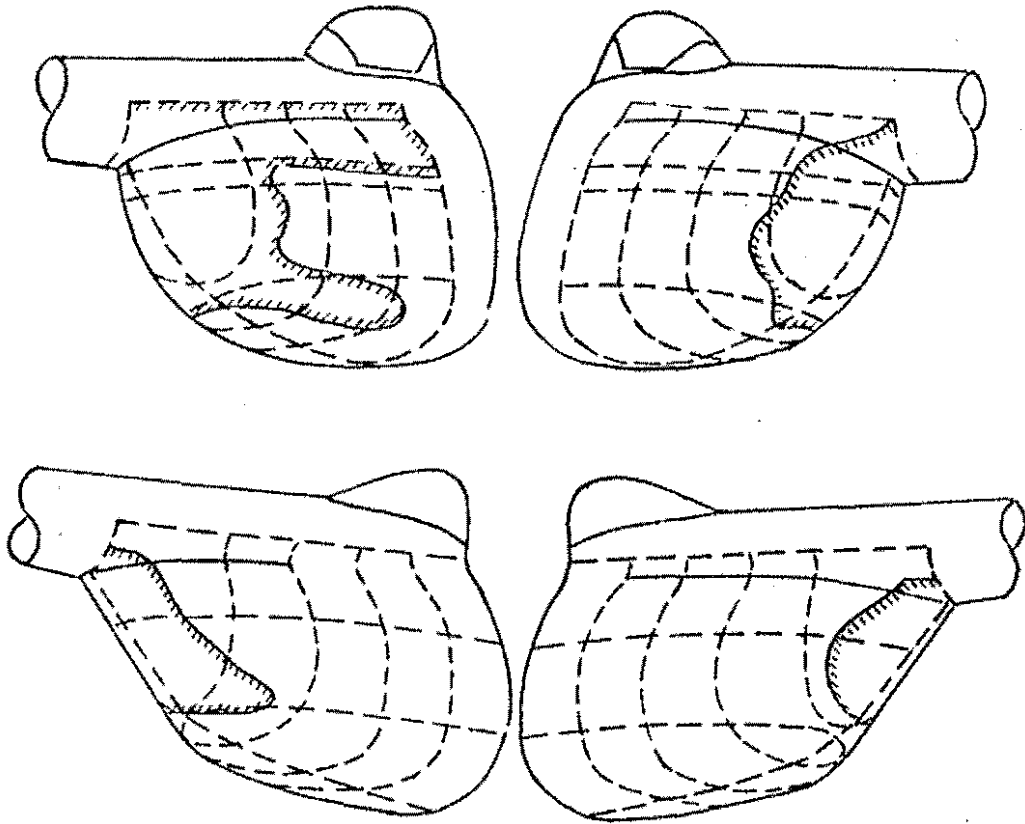

Fig.6. The stall zones on the fuselage rear at  $V = 200$  km/h

- a - the initial version;
- b - the modified fuselage rear;
- the marking for silk threads glueing;
- //// - the stall zones

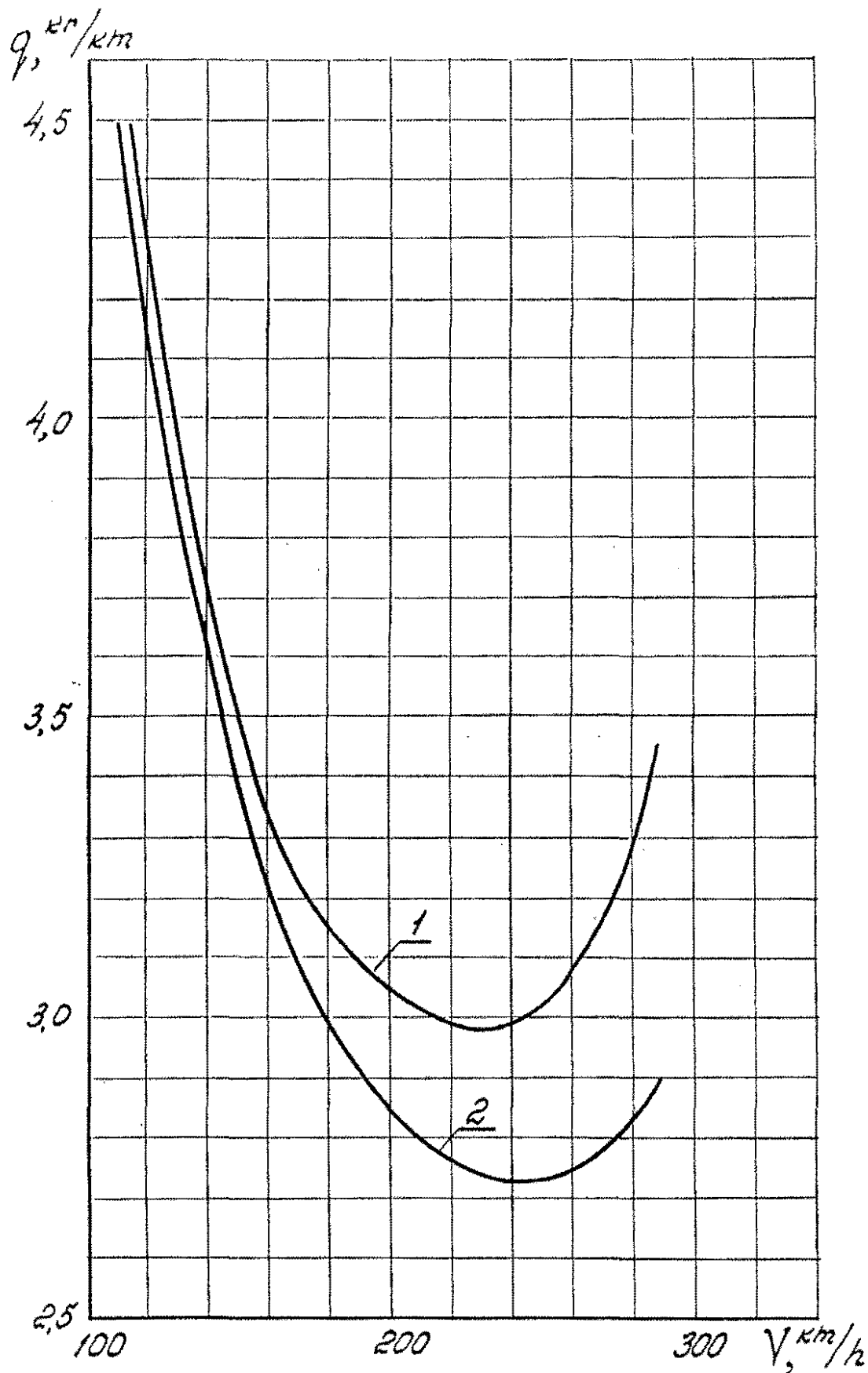

Fig.7. The fuel consumption per kilometre of Mi-8 helicopter

- 1 - the initial version of airframe;
- 2 - the improved aerodynamic configuration of airframe

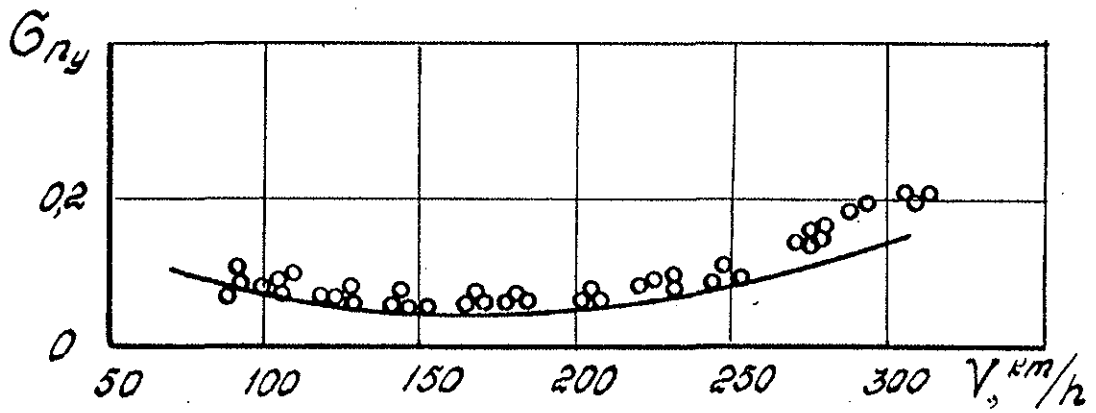
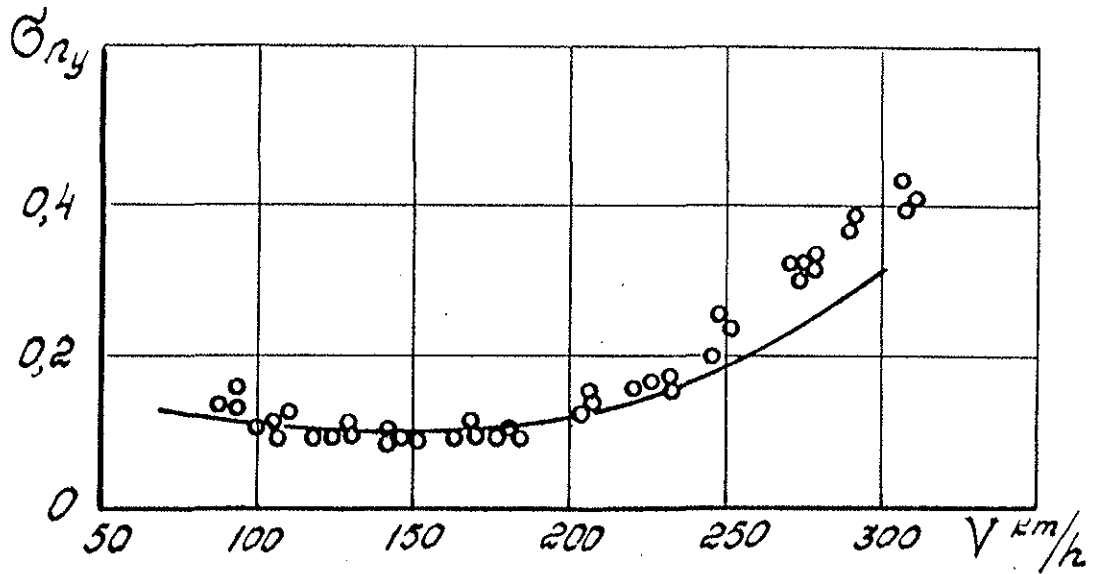

Fig. 8. The average square vibration  $g$ -loads of Mi-8 helicopter on the vertical axis

- - the initial version;
- - the improved aerodynamic configuration of airframe;
- a - in the cockpit;
- b - in the helicopter centre of mass