

REFERENCE : DY03

**TITLE : HELICOPTER VIBRATION CONTROL METHODOLOGY AND FLIGHT TEST  
VALIDATION OF A SELF-ADAPTATIVE ANTI-VIBRATION SYSTEM**

**AUTHORS :**

T. KRYSINSKI/Dynamics Manager EUROCOPTER  
D. FERULLO/Dynamics Engineer EUROCOPTER  
A. ROURE/Research Engineer CNRS

This paper presents, on the one hand, an overview of helicopter vibration control technology and on the other hand the development of a new generation of semi-active isolation system called auto-tuned SARIB<sup>®</sup> (theoretical study, rig and flight tests).

Although the rotor is one of the helicopter's basic components, it is a source of vibration liable to degrade both the efficiency of onboard systems (radar, weapons, etc...) and the comfort of the crew. The main purpose of this study – based on an existing SARIB<sup>®</sup> anti-vibration system – is to make this suspension self-adaptive and so reduce the cabin vibration levels in every flight configuration.

Initially, an analytical model had to be developed to describe the dynamic behaviour of the suspension on a fuselage assumed to be a rigid body. The self-adaptivity of the suspension was obtained by a control algorithm based on the constant step gradient method. The performance of the algorithm was determined both theoretically with the analytical model and experimentally by testing the self-adaptative suspension on a representative helicopter mockup.

Considering its satisfactory performance on a rigid fuselage, the self-adaptive suspension was then studied on a flexible fuselage with natural frequencies and natural modes. This study demonstrated that the suspension performance is not degraded by the natural modes of the fuselage.

The final step of this study was the flight test campaign for the self-adaptive suspension on a helicopter in the 8-10 metric ton class. The self-adaptivity of the SARIB suspension substantially decreases the vibration level in the cabin.

## 1. INTRODUCTION

The reduction of helicopter vibrations has traditionally been a difficult task to achieve. The oscillatory motion of the fuselage has been a concern for several reasons :

- crew's and passengers' fatigue,
- high-cycle fatigue of different components inducing low reliability and high maintenance costs,
- low performance of different weapon systems (Difficult to use sights, difficult to point missiles,....)

The major new development programs still present high risks as far as helicopter dynamics are concerned. The main industrial motivations for the improvement in helicopter vibrations are :

- helicopter acceptance in the future (comfort, weapon system platform stability) will impose low vibration levels (0.10 g → 0.05 g → 0.03 g),
- extended flight envelope (speed, load factor), wide range of payloads and fuel loads, requiring high performance antivibration devices for easy flying,
- dynamics problems during development can lead to costly development delays and impose fundamental modifications in the aircraft design.

The objective of every helicopter manufacturer is to design the new rotorcraft so as to allow « flying right from the drawing board » with minimum development time. In this paper, the following issues will be discussed :

- the origin of helicopter vibrations,

- methodology overview,
- description of new generation of semi-active isolation systems,
- validation methodology and perspectives for production application.

## 2. ORIGIN OF HELICOPTER VIBRATIONS

There are many causes for helicopter vibrations such as rotors, shaft gears, engines. These vibrations have an almost constant frequency due to the constant speed of rotating parts. The frequency range for comfort is from a few Hz to a few hundred Hz. There are also random vibrations from the air flow exciting the tail surfaces called « Tail shake ».

The aerodynamical sources of vibrations are pointed out on Figure 2.1.

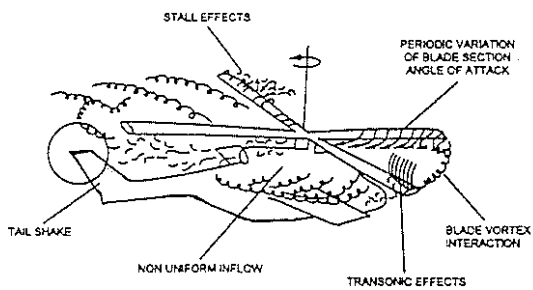

Figure 2.1 : Sources of Vibrations on Hélicopter

In this paper, we shall consider main rotor vibrations only. The vibratory response of the blade at its passing frequency is a natural behaviour in any rotor. In hover, the aerodynamic loads acting on the blades are constant as a function of azimuth and no vibratory loads are generated on the hub. In forward flight, the airoload on the blades varies during rotation due to the relative wind and incidence imposed by pitch. The loads on each individual blade are periodic at the frequency which is a multiple of one-per-rev.

The dynamic response of the blade is dependent on the fundamental blade characteristics e.g. natural frequencies, damping and mode shapes. The dynamic loads can be amplified or damped by the blades dynamics and transmitted to the rotor hub. The rotor is a filter with some cancelling and some reinforcing components.

The basic mechanism of helicopter vibrations is shown in Figure 2.2.

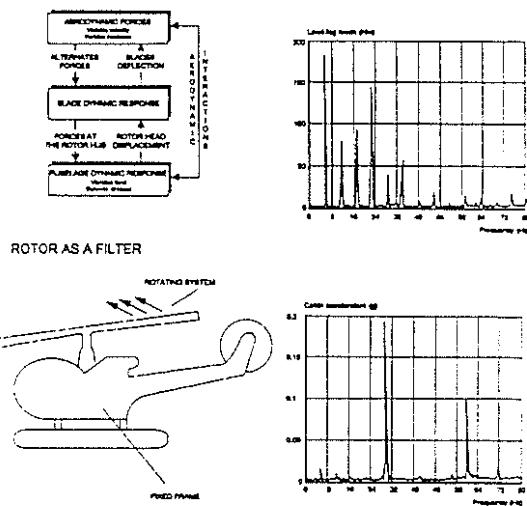

Figure 2.2 : Origin of vibrations

Another vibration mechanism is evident when blades are not identical. Blade dissimilarities can be induced by manufacturing errors or various damage. Many inspections are made during the manufacturing process (weight, mechanical properties, mold temperature, holographic inspection ...). Each blade is still slightly different from the other and cannot be fitted to the aircraft unless it is balanced. Blade defects may be of different types : weight, spanwise and chordwise c.g. position, spanwise weight distribution, airfoil shape. All can have consequences on dynamic behaviour and cabin vibrations. These non-isotropic rotor vibrations can become significant in modern helicopters when the basic N-per-rev (N - Number of blades) is overreduced. In these conditions, the resulting non-isotropic levels through the airframe can become similar to N-per-rev. vibrations levels and their association produces a beating phenomenon at low frequency which can be disturbing for the crew.

While discussing the helicopter vibrations problems, one must mention the tail shake phenomenon. The tail shakes are non-harmonic vibrations at frequency below 10 Hz in most cases. These vibrations are due to the response of the first fuselage bending modes excited by the airflow from the main rotor, aircraft engine cowlings or front fuselage. Most development programs faced the problem of tail shake and the solution was found afterwards by external aerodynamic optimization. In this overview of helicopter dynamics, we should mention the transition problems. Transition is the high vibration problem at low speed resulting from

rotor excitation generated either by its own wake or by that from the pylon. The induced velocity flow-field going through the rotor during transition is highly complex and this makes the analytical analysis very difficult. The transition problem is, in most cases, solved by dynamic tuning of the rotor, introduction of hub absorbers or isolation system at the interface with the fuselage.

### 3. OVERVIEW OF HELICOPTER VIBRATION CONTROL METHODOLOGY

Vibration control methodology is based on the following three issues :

- rotor dynamics
- fuselage dynamics
- choice of appropriate antivibration device.

#### 3.1 Rotor dynamics

In this chapter, we shall discuss the minimization of helicopter vibration from the main rotor since it is the primary source of problems. This minimization starts with appropriate tuning of main rotor characteristics. The dynamic response of a rotor blade to the aerodynamic excitation depends on this blade's natural frequencies, generalized masses and modal damping.

The aerodynamic parameters are selected mainly to improve helicopter performance in hover and forward flight. The main parameters are :

- induced velocities
- planform shape : rectangular or tapered
- tip shape : swept, anhedral
- twist.

Induced velocities resulting from the fuselage or the blade vortex interactions are a significant parameter. Fuselage optimization to reduce aerodynamic drag leads to designing compact rotor heads. In these conditions, the blades are close to the body and this amplifies the interactions in terms of fuselage induced velocities exciting the blade and gives high rotor head vibratory loads.

The number of blades is thus a highly significant factor as far as vibrations are concerned. A general argument in the helicopter community is the higher the number of blades the lower the dynamic loads at the rotor head. The choice of the number of blades is heavily influenced by other criteria like performance, price and autorotation capability.

The latest aerodynamic studies are producing new blades which are no longer rectangular but tapered with evolving tips. Their twist can be modified and an anhedral added to improve their performances in hover or at high speed. The planform influences the spanwise distribution of the aerodynamic loads as well as the dynamic properties of the blades. Tapering leads, for example, to low generalized masses for those modal shapes where dynamic response and vibration level are increased.

The different results available in the literature confirm that high twist is favourable for hover and low speed performance. The linear aerodynamic theory shows that higher harmonics blade flatwise loads are proportional to twist. The current blade design methodology is an optimization of aerodynamic performances as well as a change in internal structure to improve dynamic behaviour. The simplest methodology involves retaining a margin between blade modal frequencies and hub excitation frequencies. It is possible to increase the generalized mass or shift the frequency of the modes most critical for vibrations with tuning masses. Optimization techniques involve local stiffness and mass adjustments to globally reduce aerodynamic excitations and blade response to obtain low N-per-rev hub loads (moment, vertical and lateral shears).

#### 3.2 Fuselage dynamics

The fuselage response to rotor excitations must carefully be considered to enable high comfort aircraft to be obtained. The fuselage response varies extensively with the excitation frequency. An example is shown in Figure 3.1.

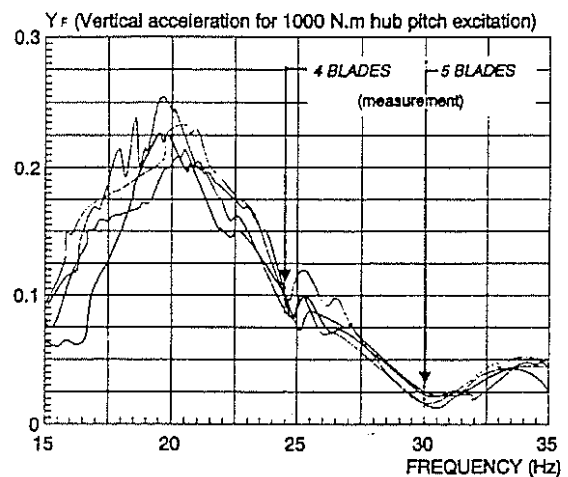

Figure 3.1 : DTPX380 Fuselage Response

The fuselage transfer is more than three times lower at 30 than at 24 Hz for experimental DTP X380 helicopter. This example shows that highly significant efforts in rotor optimization can easily be wasted with non appropriate fuselage dynamics. The helicopter structure is composed of elements which considerably differ in structural arrangement.

The structure design must be supported by finite element airframe analysis. In the design phase, every main architecture choice like implementation of frames, installation of heavy parts (engines, gearbox, ...) and interface between mechanical parts and fuselage must be validated by dynamics considerations. As far as new structures are concerned the effects of composites make the prediction of natural frequencies and mode shapes more difficult.

The difficulty comes from different new elastic coupling terms and the structural design concept of the composite fuselage is different from that of metals. Another problem is the structure identification methodology to ensure proper fuselage mode placement : finite element analysis as well as correlative ground shake tests are needed. The global optimization of the structural models is impractical. This is why every company is looking for simplified models which are much easier to use for parametric studies and optimization techniques.

### 3.3 Antivibration devices

Upgrading performance, mission duration and comfort of the crew, imperfect control of forced vibration dynamic and aerodynamic problems at design level, require development of antivibration devices. The problem proves difficult since the vibration technology has to meet the following requirements :

- system with an infinite service life
- reliability
- reduced maintenance
- minimum weight
- minimum dimensions.

The antivibration devices are broken down into 3 classes :

- at the rotor hub
- at the rotor-to-fuselage interface - upper deck
- in the fuselage.

In these three classes, we can distinguish three categories : passive, semi-active and active systems. These different technologies are described in Figure 3.2.

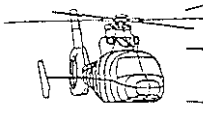

	PASSIVE	SEMI-ACTIVE	ACTIVE
ROTOR HUB	RESONATORS - PENDULUM MASS - HUB ABSORBER - CROSS RESONANCE	Auto-tuned hub absorber	HHC IBC
UPPER DECK	SBQ SARIB RESONATORS - STRUCTURE - FUSELAGE	Auto-tuned SARIB	ACSR
CABIN	Mechanic RESONATORS	Auto-tuned RESONATORS	Cabin actuators

Figure 3.2 : Antivibration devices

Blade-Mounted or hub-mounted dynamic absorbers (pendulum mass, bifilar, hub absorber or roller absorber) are the most popular antivibration devices used on helicopters. The resonance tuning of these dynamic absorbers must be close to the rotor harmonic to be reduced. An example of rotor hub absorber is given in Figure 3.3.

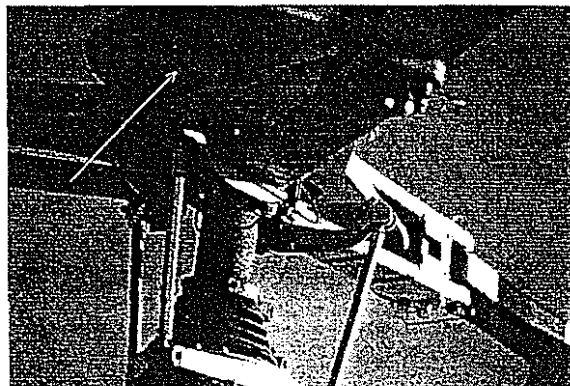

Figure 3.3 : Rotor Hub Absorber : 350 Application

An example of pendulum masses applied to Super Puma MK2 is given in Figure 3.4.

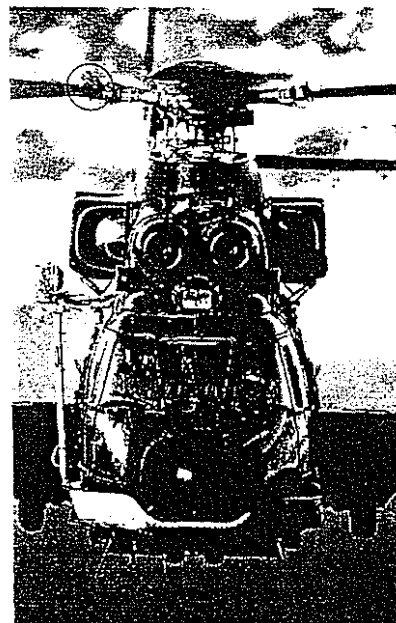

Figure 3.4 : Pendulum Masses : Super Puma Application

This absorber is secured to the rotor hub. The advantage of this technology is the ability to filter 2 frequencies in the rotating system. The efficiency example is given in Figure 3.5.

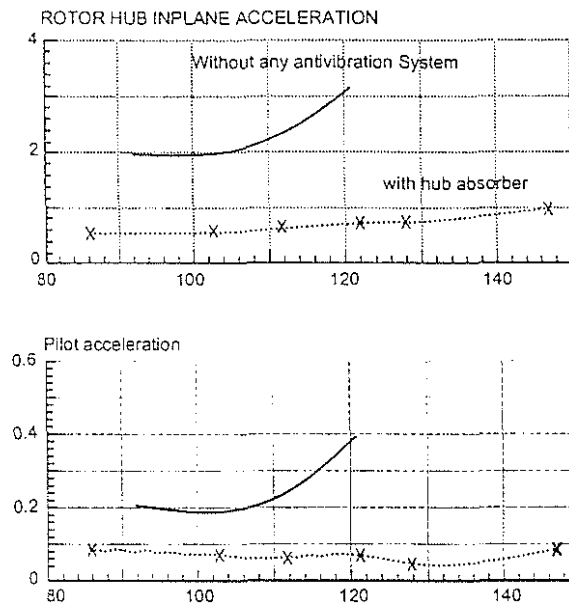

Figure 3.5 : Rotor Hub Absorber : Efficiency on vibrations in the cabin

The reduction of vibrations in the cabin is directly correlated with the decrease of in-plane vibrations on the hub.

### 3.4 Upper deck suspensions

Eurocopter has been one of the first helicopter manufacturers to offer, on the market, a focal point suspension system so-called "barbecue". This system was applied to SA 330 Puma. The principle was to use soft elements at the bottom of the gearbox to filter the vibrations. The satisfactory results obtained on SA 330 Puma boosted the development of several derivatives on AS 332, Dauphin and Ecureuil. The simplification comes from the use of laminated elastomer mounts and flexible composite bars. The three systems shown in Figure 3.6, are still in operation, fulfil their functions very well and make the products highly competitive as regards vibration comfort.

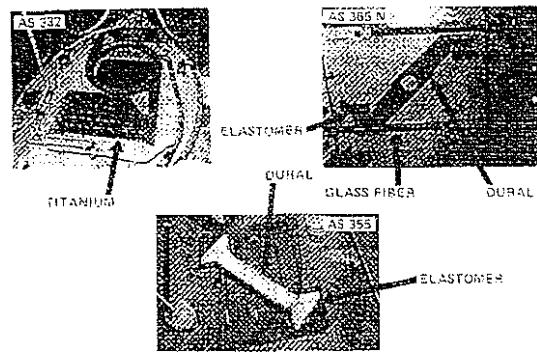

Figure 3.6 : Various principles of barbecue suspensions

A new generation of suspension system so-called "SARIB<sup>®</sup>" was developed in recent years.

SARIB<sup>®</sup> is an anti-resonance isolation system, which consists, as shown in Figure 3.7, of 4 individual units equispaced around the gearbox. One unit consists of a leaf spring, the flapper arm and the flapper mass. The leaf spring is designed with two parallel flanges at the stiff end. One bolt connects, through the outer bearing, the leaf spring, to a bracket on the gearbox deck and another bolt connects the leaf spring to a gearbox strut. Elastomeric bearings are provided at both connections.

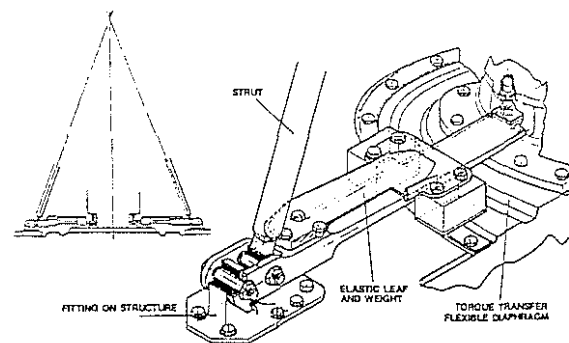

Figure 3.7 : SARIB Anti-Resonance isolation system

The elastic side of the leaf spring is supported at the bottom of the gearbox. The amplification needed for flapper mass oscillation is realised through the flapper arms and their connections to the stiff part of the leaf spring, close to the gearbox strut. A membrane provided between the bottom of the gearbox and the fuselage transmits the rotor torque. Excellent vibration levels were achieved with SARIB<sup>®</sup> isolation for different missions and weapon configurations.

### 3.5 HHC, IBC

The  $b/\text{rev}$  (where  $b$  is the number of blades) vibration in helicopters comes from higher harmonic air loads ( $b-1/\text{rev}$ ,  $b/\text{rev}$ ,  $b+1/\text{rev}$ ) acting on the rotor blades. The HHC (Higher Harmonic Control) principle is a generation of controls on rotating swashplate at frequency  $(b-1)/\text{rev}$ ,  $b/\text{rev}$ ,  $(b+1)/\text{rev}$  through non-rotating swashplate control frequency equal to  $b/\text{rev}$ . These higher harmonic control inputs give opposing loads, and this allows reducing the vibrations in the fuselage - Figure 3.7

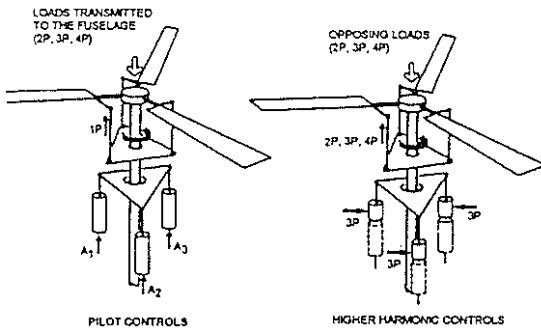

Figure 3.7 : Higher harmonic control principle on non-rotating swashplate (three-blade rotor)

The optimum higher harmonic controls are calculated at any time in the digital computer where the control law identification and computation algorithm is programmed. The observation parameters are the fuselage accelerations. The efficiency of the system is shown in Figure 3.8 for an experimental SA 349. Very similar results can be achieved with IBC (Individual Blade Control) using the actuators directly in the rotating system.

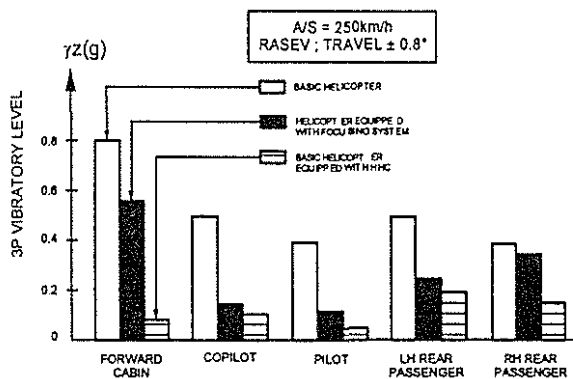

Figure 3.8 : Comparison with passive-type system

### 3.6 ACSR

The ACSR (Active Control of Structural Response) principle is the superimposition of the primary vibration response given by the main rotor and the secondary imposed vibrations which are controlled to minimize the total vibrations in the cabin. The secondary imposed vibrations are applied to the structure with hydraulic actuators - Figure 3.9.

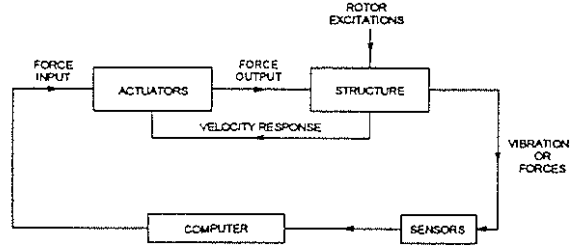

Figure 3.9 : ACSR Principle.

The flight test results obtained with experimental Dauphin DTV2 are shown in Figure 3.10. The control algorithms are very similar to those used for HHC and IBC. The observation parameters are the accelerometer in the fuselage or vibratory loads measured on the main load paths between the mechanical parts and the airframe.

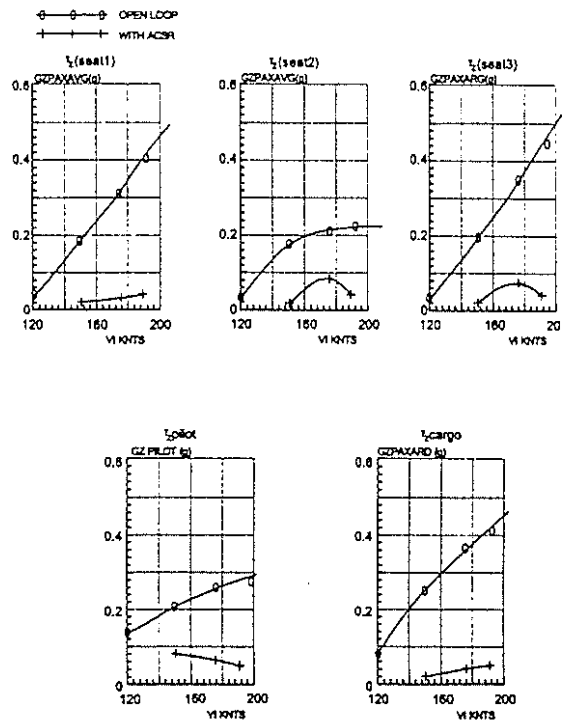

Figure 3.10 : ACSR Results on DTV2.

#### 4. NEW GENERATION OF A SEMI-ACTIVE ISOLATION SYSTEM : Auto-tuned SARIB®

The main targets of semi-active isolation systems are :

- Efficiency compared to passive systems and capacity of adaptation for variable configurations or variable RPM.
- Satisfactory convergence and robustness of a constant gradient algorithm.
- Low price compared to existing active systems.

##### Notations :

$X_F, Y_F, Z_F$  : longitudinal, lateral, vertical translations of the fuselage mass center.

$\alpha_x, \alpha_y$  : roll and pitch rotations of the fuselage

$Z_{BTP}$  : vertical displacement of the Main Gear Box (MGB)

$\theta_x, \theta_y$  : roll and pitch rotation of the MGB / fuselage

$f_{q_1}, f_{q_2}, f_{q_3}, f_{q_4}$  : vertical translation of the four flapping masses

Tuning of SARIB® isolation system is a compromise between the different excitation components. Figure 4.1 gives the vibrations level in the cabin as a function of the flapping mass in 5/6t helicopters for different rotor hub excitations.

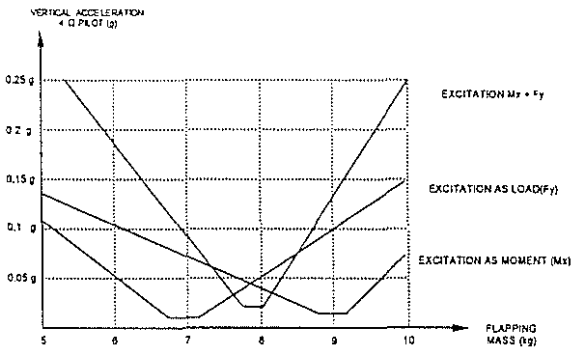

Figure 4.1 : Changes in pilot vertical acceleration versus beating mass.

It was noted that the optimum mass is 7 kg for in-plane force up to 9 kg for pitch moment excitation. The SARIB® system can be tuned with a modification of the amplification ratio. This tuning is achieved with a small electric motor pushing the masses on two sliding bars. This tuning allows adjusting the isolation system to different vibratory loads which change as a function of forward speed

and flight configuration as well as to different modal fuselage characteristics which can be modified with a change in aircraft loadings.

We have to cope with nonlinear control because the modification of the SARIB® amplification ratio changes the natural frequencies of the system. The gradient algorithm was applied to control the masses and movement of the auto-tuned SARIB®.

The target was to minimize a non linear cost function  $F$  dependent on the four flapping mass positions ( $c_i$ ).

$F$  was defined :

$$F = \sqrt{\frac{\sum_{i=1}^N \gamma_i^2(c_1, c_2, c_3, c_4)}{N}}$$

With :  $\gamma$  : acceleration modulus analysed at the  $b\Omega$  frequency.

$N$  : number of accelerometers

Should  $c_i^k$  represent the flapping mass position at the  $k^{\text{th}}$  step, the constant gradient algorithm may be written as

$$c_i^{k+1} = c_i^k - dc * \text{sign}\left(\frac{\partial F}{\partial c_i^j} dc\right)$$

where  $c_i^{k+1}$  represents the new flapping mass position, and  $dc > 0$  the displacement step.

The validation programme started with rig tests. A mock-up of the auto-tuned SARIB® was built - Figure 4.2.

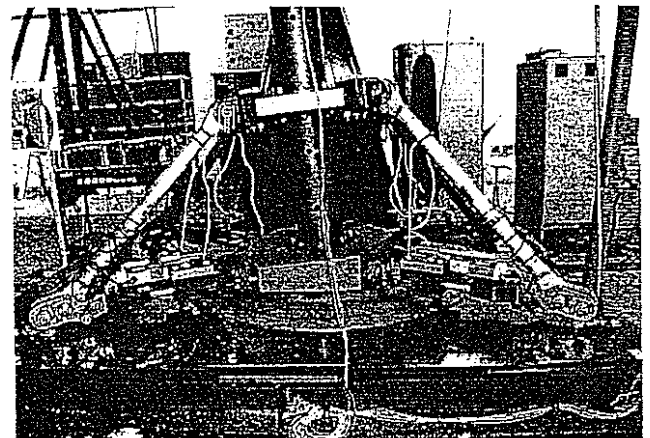

Figure 4.2 : Auto-tuned SARIB rig tests.

The analytical modes were derived for the theoretical simulations Figure 4.3.

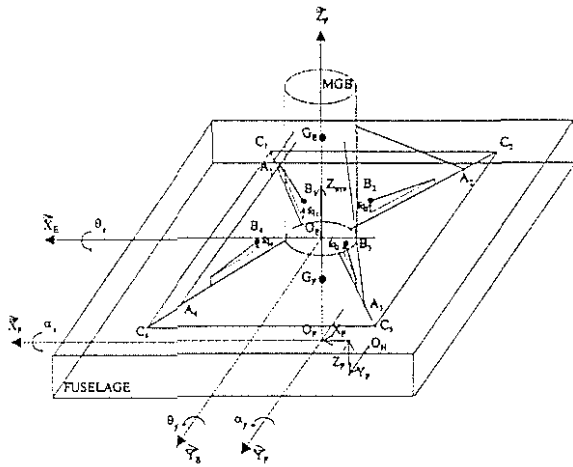

Figure 4.3 : Theoretical modelisation of auto-tuned SARIB

A high auto-tuned SARIB<sup>®</sup> efficiency was demonstrated during the rig tests. Auto-tuning capabilities examples are shown in Figure 4.4 in the frequency change case. A high similarity was obtained between simulations and rig test.

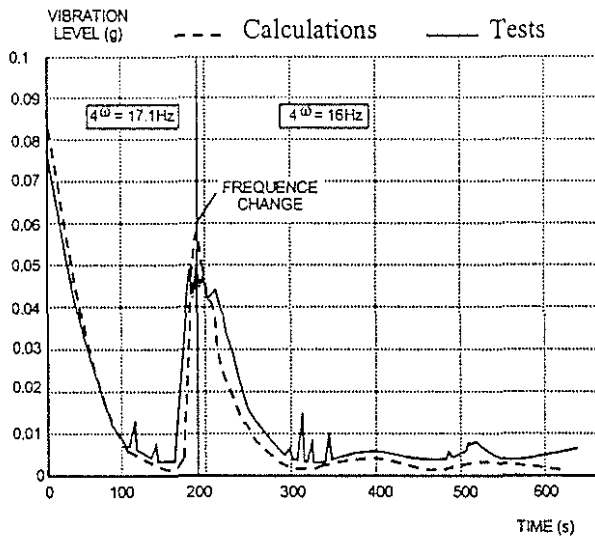

Figure 4.4 : Auto-tuned SARIB – Rig test results

The satisfactory rig test results urged us to test the auto-tuned SARIB<sup>®</sup> in flight on a 10-ton helicopter. Figure 4.5 and Figure 4.6 show an exemple of algorithm convergence at a speed of 140 Kts. The twelve vertical accelerometers average and flapping masses positions are plotted versus time. The average decreases from 0.15g to 0.1g and flapping masses converge to optimal positions.

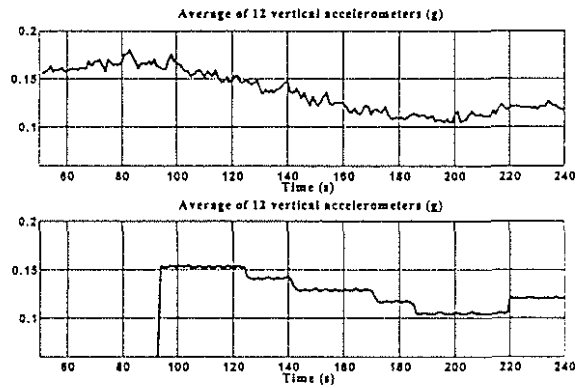

Figure 4.5 : Flight test results 140 kts : Evolution of the average versus time

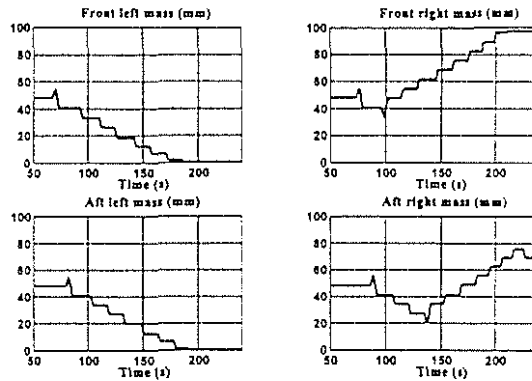

Figure 4.6 : Flight test results 140 kts : Flapping masses positions versus time

The flight test results on a 8/10 ton class helicopter – Figure 4.7 showed a 40% vibration level reduction compared to passive SARIB<sup>®</sup>. The vibration level was very good with passive SARIB<sup>®</sup> and excellent with the autotuned version. The controller demonstrated a highly stable behaviour throughout the flight envelope.

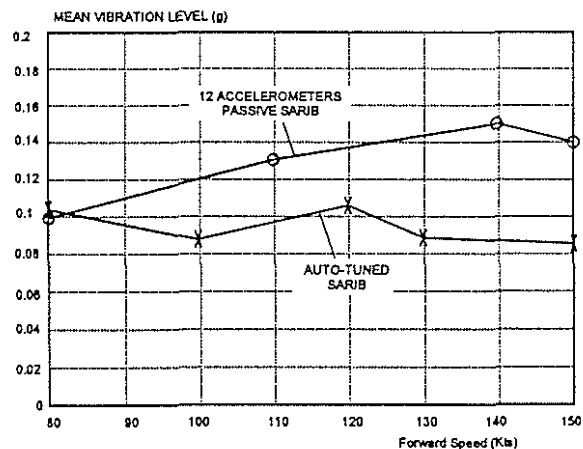

Figure 4.7 : Flight test results with auto-tuned SARIB.



## 5. CONCLUSION

The new generation of auto-tuned isolation systems was presented and compared to existing passive and active systems. The full validation of auto-tuned SARIB<sup>®</sup> resonator was achieved through rig tests and flight tests. The main advantages of this new technology are :

- a/ Efficiency compared to passive systems and capacity of adaptation for variable configurations or variable RPM.
- b/ Satisfactory convergence and robustness of a constant gradient algorithm.
- c/ Low-price compared to existing active systems.

The production version studies are under way for applications on future products.

## REFERENCES

### 1. Y.A. MYAGKOW

*Vibrations of helicopters of « MI Family, Investigation vibrations absorbers application, buffet » European Forum, 14-16 XI 1993*

### 2. W. HOWRYLECKI, J. KLIMKOWSKI

*« Roller vibration absorber for helicopter main rotor hub » European Forum, 14-16 XI 1993*

### 3. P. RICHTER, A. BLAQS

*« Full scale wind tunnel investigation of an individual blade control system for the BO 105 hingeless rotor », European Forum, 14-16 XI 1993*

### 4. R.B. TAYLOR

*« Helicopter vibrations reduction by rotor blade modal shaping » 38th Annual Forum of the AHS, Anaheim, CA ; May 1982*

### 5. S.P. KING

*« Fuselage response as a factor in vibrations. Structural Dynamic and Response & its Control » The Royal Aeronautical Society, 10 I 1990*

### 6. S.P. VISWANATHAN - A.W. MYERS

*« Reducing of helicopter vibrations through control of hub impedance », Journal of the American Helicopter Society - Volume 25 - Number 4, October 1990*

### 7. F. BEROUL - L. GIRARD - E. ZOPPITELLI, T. KRYSINSKI

*« Current state-of-the-art regarding helicopter vibration reduction and aeroelastic stability augmentation » 18th European rotorcraft Forum, 15-18 IX 1992 - Avignon*

### 8. M. POLYCHRONIADIS, M. ACHACHE

*« Higher harmonic control : Flight tests of an experimental system on SA 349 Research Gazelle » 42nd Annual Forum of the AHS, June 1986, Washington*

### 9. Richard L. BIELAWA

*« Rotary wing structure dynamics and aeroelasticity », Education Series*