

# TWENTYFIFTH EUROPEAN ROTORCRAFT FORUM

Paper No: M8

## A HUMS Maintenance Credit Case Study

By:

**Christopher Neubert**, U. S. Navy System Safety Engineering

**Bill Hardman**, U.S. Navy Propulsion and Power Diagnostics

**Andrew Hess**, U.S. Navy Propulsion and Power Diagnostics

September 14-16, 1999

Roma

Italia

ASSOCIAZIONE INDUSTRIE PER L'AEROSPAZIO, I SISTEMI E LA DEFESA ASSOCIAZIONE ITALIANA  
DI AEROMAUTICA ED ASTRONAUTICA



## The Authors



### **Christopher Neubert**

U. S. Navy System Safety Engineering

Chris is a graduate of Parks College of Saint Louis University, where he studied Aeronautics and acquired FAA sanctioned Private Pilot's, and Airframe/Powerplants Mechanics Licenses. He began work at the Navy's Trenton facility where he orchestrated the operation of the \$.75 billion altitude test facility, and various fighter, helicopter, and cruise missile air breathing engines. In 1988 he moved to helicopter transmission engineering and was assigned to the H-60 and V-22 aircraft where in 1993 he began work on the Helicopter Integrated Diagnostic System Program, of which he became Program Manager in 1996. Chris is now the System Safety Liaison to the Integrated Mechanical Diagnostic HUMS program, for which he supports the H-53, H-60, and H-1 aircraft.



### **Bill Hardman**

U. S. Navy Propulsion and Power Diagnostics

Bill is a Diagnostics Engineer for the Propulsion and Power Department of the Naval Air Warfare Center, Patuxent River, MD. He has been working on diagnostic and control system applications for more than ten years. Major projects include the following: Integrated Mechanical Diagnostics Health and Usage Monitoring System, Helicopter Integrated Diagnostic System (HIDS) (for which Bill was Program Manager), F414 engine control system development, and support engineer for the T700 engine control. He holds a BSME from Temple University and a MSME from Drexel University. Of particular note, Bill has played a key role in developing novel techniques for bearing fault detection and is regarded as the Navy expert in drive systems diagnostics.



### **Andrew Hess**

U. S. Navy Propulsion and Power Diagnostics

Andy is world renown for his work in fixed and rotary wing health monitoring and is recognized as the father of naval aviation diagnostics. Beginning with the A-7 aircraft engine health monitoring program of the early 80's, Andy has been a leading advocate for health monitoring in the Navy. His efforts have largely led to the successful transition of a development program (HIDS) into production (IMD HUMS) for all H-60, H-53, and H-1 aircraft. Currently, Andy is hard at work integrating health and usage for the Joint Strike Fighter program and frequent participant in the international technical community.

## A HUMS MAINTENANCE CREDIT CASE STUDY

By

**Christopher Neubert**, U. S. Navy System Safety Engineering  
**Bill Hardman and Andrew Hess**, U. S. Navy Propulsion & Power Diagnostics Engineering

### **Abstract**

There is great concern in the U. S. Navy/Marine Corps aircraft community regarding outyear operating costs. Simply put, there will not be sufficient funds for the services to execute their mission goals. Studies and initiatives have been undertaken to reduce Operational and Support Costs, with a keen interest in Condition Based Maintenance (CBM) and a re-structuring of the logistics infrastructure. For example, the U. S. Marine Corps' Integrated Maintenance Concept (IMC) is investigating the transition of Depot and Intermediate Levels of Maintenance to the field with a goal of reducing operating costs while maintaining readiness and safety. Another program, the Integrated Mechanical Diagnostics Health and Usage Monitoring System (IMD HUMS), will integrate a state-of-the-art helicopter HUMS with a "total asset visibility" maintenance tracking logistics network. These tools will provide the Naval aviation community with great opportunities to change the method maintenance is performed, i.e. maintenance credits.

This paper will focus on a specific fleet problem in the SH-60 helicopter main transmission, and provide a method to transition its maintenance activity from the Depot Level to the Organizational (field) Level. Discussed will be the proposed new maintenance activity (credit), failure modes, empirical history of the component, fault detection, prognostics, safety risk, with supporting evidence in cost, readiness and manpower. The template for this credit will be considered for use to validate and implement other maintenance credit activities on IMD HUMS equipped Navy/USMC helicopters.

### **IMD HUMS**

Compared with fixed-wing aircraft, helicopters have a far greater number of dynamic components in the rotor system and drive train. Many components are life limited, and most require significant troubleshooting and maintenance. Current diagnostic techniques depend heavily on manual fault detection and isolation. Thus, maintenance is labor intensive and dependent on experienced personnel. This process is inexact, leading to a sequential "remove and replace" approach based on incomplete or inaccurate data. This may result in maintenance-induced damage or retirement of components with remaining useful life. The IMD HUMS system combines several significant diagnostic capabilities into an even more capable integrated system (R1).

In 1997 the U.S. Navy embarked on an innovative approach to fielding an integrated mechanical diagnostic system to improve flight safety and significantly reduce the operations and support cost for Navy helicopters. Sponsored by the Department of Defense's Joint Dual Use Program Office, the Navy and B.F. Goodrich Aerospace began an accelerated program to field a militarized version of a commercial health and usage monitoring system for the CH-53E and SH-60B helicopters. Monitoring and diagnostic capabilities include rotor track and balance, engine performance and health monitoring, gearbox and drive train health monitoring, structural usage and fatigue life tracking, and maintenance trending. The system reduces operations and support costs by providing timely and accurate information to the fleet operators, maintainers, and flight personnel. The fielded system will be an easy to use decision aid, providing information and direction, not data. Flight readiness and safety are also enhanced through early identification of degraded components.

IMD HUMS has employed an Integrated Product Team (IPT) approach to identify and mitigate safety and program risks by engaging in activities such as:

- IPT's consisting of aircraft Original Equipment Manufacturer, Federal Aviation Administration (FAA), and Navy design authority experts.
- Complying with the maintenance credit certification requirements outlined by the FAA Draft Advisory Circular for helicopter health and usage monitoring systems.
- Recording and archiving of raw data for system validation, improvement and maturation.
- Team participation from the DoD Open Systems Joint Task Force.

Risk reduction programs such as the Helicopter Integrated Diagnostic System (HIDS), CH-53 Early Operational Assessment (EOA), and Structural Data Recording System have provided Navy competency leaders with significant insight into the capabilities and limitations of helicopter health and usage functions. IMD will

provide improved readiness via reductions in operational and support costs, maintenance man hours per flight, and scheduled component removals. These benefits can be realized while maintaining reliability and safety margins.

### Diagnostics and Prognostics

The U. S. Navy performed considerable risk reduction development and evaluation testing of available and advanced mechanical diagnostics technologies during the HIDS (R2) and EOA programs. Seeded and propagation fault tests at the Navy's Helicopter Transmission Test Facility (HTTF) were successful in demonstrating the robust B. F. Goodrich diagnostic package for the detection of shaft, bearing, and gear defects. Furthermore, flight trails on several SH-60 helicopters successfully diagnosed a gear defect in the input module, and a "first of a kind" bearing defect in the main transmission. Novel approaches such as parallel acquisition, discrete frequency tone detection for bearings, and raw time domain data recording were found to be useful tools for the fielding of the production IMD HUMS system.

In addition to being a permanently mounted device, the IMD HUMS provides the following safety benefits over commercially available helicopter health monitoring devices:

- Better component health methodology
- Diagnosis of all mechanical diagnostic system components
- Redundant analysis of mechanical components
- Capabilities for real-time cockpit warnings and alerts.

The fault propagation testing performed during HIDS provided an understanding of failure progression and diagnostic indicator dynamics. This insight allows us to consider the opportunity for prognostics.

Prognostics can be defined as the capability to provide early detection of the precursor and/or incipient fault condition; and predict the progression of this fault condition to failure. Fault condition is tracked and safely "managed" using a variety of diagnostic indicators until such time as maintenance actions is warranted. This type of maintenance philosophy can be used to manage fleet assets based on the tempo of operations. If the availability of the defective asset is not critical and the failure mode is understood, maintenance can be scheduled in a timely manner so as to minimize secondary damage. If aircraft availability is of importance, the failure progression can be monitored by IMD HUMS to insure aircraft safety until such time maintenance can be performed (R3).

### The Integrated Maintenance Concept (IMC)

The Integrated Maintenance Concept (IMC) is a U. S. Navy logistics initiative aimed at reducing operational costs and increasing aircraft availability (R4). Aircraft repair costs are exceeding available funding, and reduced aircraft readiness is affecting mission completion. Aircraft are being removed from service for Scheduled Depot Level Maintenance (SDLM), but their time-in-repair is increased due to lack of funding, parts, etc. Aircraft fleet re-entry is delayed thereby decreasing readiness. The logistics community has identified a novel approach which addresses the above concerns by integrating depot level maintenance functions and resources into the organizational (squadron) level 200 hour phase interval inspections (See Table 1).



200 hour Phase Inspection at 'O' Level																	
A	B	A	B	A	B	A	B	A	B	A	B	A	B	A	B	A	B
																	
'D' Level Phase Inspections to Coincide with 'O' Level Phase Inspections																	
A	B	C	D	E	F	A	B	C	D	E	F	A	B	C	D	E	F
One completed SDLM Cycle						One completed SDLM Cycle						One completed SDLM Cycle					

Table 1

IMC is a transition from a Restoration Maintenance approach to a Prevention Maintenance Program. Reliability Centered Maintenance principles were used to identify corrosion, structural defects, fuel and hydraulic systems as SDLM tasks for transition. These problem areas can receive more frequent inspections and preventative maintenance. Depot level personnel and facility resources are re-distributed to squadron locations. The Navy seeks to leverage IMD HUMS as a means to identify additional IMC process improvements, with the following identified as benefits:

- IMC needs improved RCM data and traceability. IMD HUMS promises to improve identification and tracking of component defect and removal causes. Improves ability to trace locations of defective components.
- Component degradation visibility. Typically, a helicopter transmission's most common reason for unscheduled removal is for metal contamination (chips). The limitation of chip detectors is that they isolate the source to the assembly level. When a transmission is removed for this cause the only means of identifying the chip source (defective component) is the costly execution of an Engineering Investigation (EI) at the depot repair facility. Because there is limited funding for Engineering Investigations (EI's), the source (defect) of these chips is often uncertain. IMD HUMS will be able to interrogate the defect to the part number vice assembly level. This will help to target EI's to areas which are believed to be (via IMD diagnostics) frequently defective. The EI can therefore be used as a means to confirm part degradation, instead of a "blind" means of identifying the source of chips. Fewer EI's are required with a result of fully understanding the trouble areas of a transmission. Resources can then be directed at improving component design, thereby attaining the goal of a safer, more reliable aircraft.
- Identify transmission component defects at the part number level and generate depot level "repair" procedures in lieu of complete gearbox overhaul. This will reduce cost of returning the transmission to service.
- Provide feasibility to perform transmission depot level maintenance at the organizational (fleet) level.

### System Safety Risk Assessment

All NAVAIR aircraft programs are managed via the Integrated Product Team (IPT) approach. The System Safety IPT executes the aircraft System Safety Program Plan to assure system safety principles are integrated into the aircraft system. Objectives are the identification and mitigation of hazards throughout the aircraft life cycle. Hazard assessments are performed to identify and evaluate design and/or procedural risk (R5).

A System Safety Hazard Analysis has been performed for the field replacement of the SH-60 main transmission input pinion assembly. System Safety principles are implemented in Appendix A to assess the risk of the proposed maintenance credit, which in this case is presumed to increase risk:

- Worst case hazard severity including possible failure modes
- Hazard probability including fleet history
- Risk mitigation using special tooling and diagnostics provided by IMD HUMS and IMC
- Prognostics of managing the condition of the SB2205 bearing condition.
- Initial and final risk indices

These analyses are integrated into the Appendix B Maintenance Credit Risk Assessment Chart, providing guidance in the categorization of risk and subsequent action (R6).

### HUMS Maintenance Credit Development

Maintenance credit (R7) is defined as the "Authorization by the airworthiness authority of a reduction in, or removal of, a maintenance action as a result of a having a HUMS." The credit typically depends upon the HUMS function (i.e. Rotor Track and Balance, transmission vibration monitoring, etc.). For example, regime recognition and high cycle fatigue structural monitoring can be used as a means to increase retirement times of life limited components. The optimization of IMD HUMS is the continuing trade-off between safety and maintenance (credits). Health monitoring of the aircraft dynamic components can lead to the reduction of maintenance activities. The cancellation or extension of maintenance activities enables cost and readiness improvements, but with the implication of reducing aircraft safety. Concurrently, condition assessment of these failure modes improves safety.

Because the maintenance credit process affects airworthiness, guidance in the process has been provided by the Rotorcraft Health and Usage Monitoring System Advisory Group (RHUMSAG) Airworthiness Circular of October 1997. With input from commercial operators and avionics manufacturers, the civil airworthiness authorities defined the credit process:

- Identify credit
- Identify issues related to HUMS as an effective method to enhance current maintenance practice
- Compare existing procedures and proposed changes
- Identify responsibilities for management of health monitoring (airworthiness assurance) related to credit

## A HUMS Maintenance Credit Case Study

- Produce submittal to Airworthiness Authorities

Later, Eurocopter France (ECF) presented a more detailed process (R7):

- Description of credit
- Understanding of the mechanism of degradation/failure mode associated with maintenance credit activity
- Validation methodology
- Introduction to service including Airworthiness submittal
- Continued airworthiness assurance (via monitoring)

The U. S. Navy intends to add the following activities/granularity to the maintenance credit validation process:

- Cost and readiness benefit of the proposed credit
- Criticality of the proposed credit
- Analysis of failure modes (to be included in risk assessment)
- In-service historical evidence of credit related component malfunctions (to be included in risk assessment).
- Risk assessment of the proposed credit
- Demonstration of diagnostic techniques to be used as evidence.

### Proposed SH-60 Maintenance Credit:

**Background of Proposed Credit:** During the 1989 to 1991 time frame, the SH-60 fleet was plagued with main transmission unscheduled removals due to spalling on the pinion integral raceway of the SB2205 bearing (see figure 1). The spalling generated chips which exceeded maximum allowable limits at the chip detector, requiring mandatory transmission removal and overhaul at the depot. In this time period, 27 transmissions were confirmed to have been removed due to the raceway spalling. Manufacturing and installation improvements were made (though the problem still remains to an extent, see Appendix A SB2205 risk assessment). During the HIDS program, the 38104 pinion assembly was often targeted for diagnostic testing. Integral raceway and gear fault tests required the HIDS team to remove and replace the pinion assembly nine times. The HIDS team developed a procedure which could reliably perform the removal and installation of this assembly in the test cell, thereby foregoing the need to send the transmission to a costly overhaul. Key issues in the procedure were the (1) replacement of a pinion with the same backlash as that being removed, (2) protecting the integral raceway surface during installation, and (3) needing to remove only the adjacent input module to gain access to the pinion assembly (see Figure 2). Critical tooling which measured backlash and bearing endplay were developed and implemented. The HIDS team then later considered this activity to be a maintenance credit candidate.

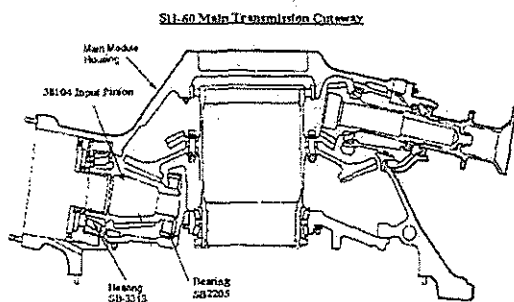

Figure 1: SH-60 Main Transmission Cutaway

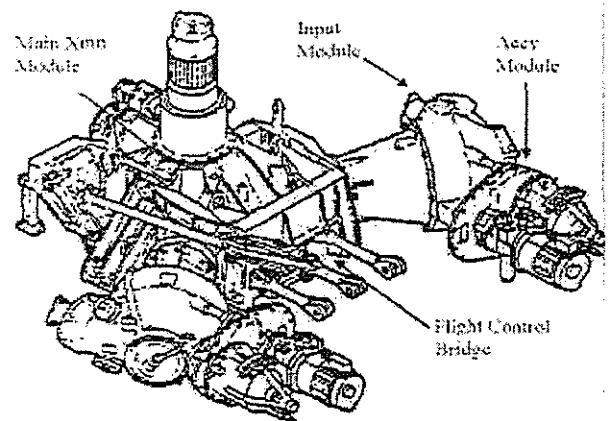

Figure 2: Assembly Showing Adjacent Components

**Description of Credit:** Perform field replacement of degraded SH-60 helicopter main transmission input pinion P/N 70351-38104-102. Current practice requires removal and replacement of transmission when the rejection criteria (chip generation) is met. Benefits are improved aircraft readiness and reduced cost to squadron (operator).

**HUMS Issues Related to Proposed Credit:** IMD HUMS will provide: (1) Component degradation detail to the part (bearing) vice assembly (transmission) level and (2) a maintenance tracking database which will coordinate material requirements. IMC will provide a maintenance infrastructure to integrate tooling, personnel, and other resources to the maintenance proposed.

**Cost and Readiness Benefit of the Proposed Credit:** A comparison of the existing and proposed repair procedures is presented in table 2. See figure 2 for component locations.

Existing Maintenance	Proposed Credit Maintenance
1. Disconnect related flight controls	1. Disconnect related flight controls
2. Remove rotor head	2. Fold rotor head
3. Disconnect engine from input module	3. Disconnect engine from input module
4. Remove Input Module	4. Remove input module
5. Remove bridge assy (flight controls)	5. Remove defect pinion assy from main transmission
6. Remove defective main transmission	6. Install new pinion and perform backlash and endplay checks. Unfold/fold rotor head.
7. Install new main transmission	7. Install input module
8. Install Bridge assy	8. Connect engine to input module
9. Install input module	9. Perform Check Flight including high speed shaft balance. No RT&B required.***
10. Connect engine to input module	*** 1 hour Check Flight penalty run required
11. Install Rotor Head	
12. Connect flight controls	
13. Perform Check Flight including high speed shaft balance and RT&B	

Table 2

Estimates provided by Naval Aviation Depot Cherry Point site the time required for the tasks on the left as 223 man hours. The estimate to remove and replace an input module (tasks 1-5, 7-9 on the right column) is 43 man hours (add 10 hours for penalty run). A conservative estimate of 40 hours is assumed to execute task 6, bringing the proposed maintenance credit procedure to 93 man hours. Man hour rate is \$16.64/hour. In readiness, the existing procedure keep the aircraft in maintenance for 3-4 days, the proposed maintenance credit would reduce this to 1 day. Labor costs and materiel costs are as follows:

Existing Maintenance	Cost	Proposed Credit Maintenance	Cost
<b>Labor</b>			
223 man hours	\$3710.72	93 man hours	\$1547.42
<b>Materiel</b>			
Main Transmission	\$146,350 with turn in	Pinion and related consumables	\$8000
<b>Total Cost</b>	<b>\$150,060.72</b>		<b>\$9547.42</b>

Table 3

**Criticality of the Proposed Credit:** The proposed credit is hereby classified as hazardous. Direct evidence is required for HUMS credit substantiation (R7). Evidence is provided in the "Diagnostics to be Used as Evidence" paragraph.

**Analysis of Failure Modes:** The description and analysis of the component and aircraft failure modes are included in the Appendix A risk assessment.

**In-Service Historical Evidence of Credit Related Component Malfunctions.** Component history of the pinion assembly are included in the Appendix A risk assessment. The number of SH-60 flight hours since 1989 is 1,025,406.

**Risk Assessment of the Proposed Credit:** For the maintenance credit activity proposed in this paper, System Safety Hazard Analyses for the main transmission input pinion and support bearings are presented in Appendix A.



Included are issues pertaining to the proposed repair procedures and their affect on aircraft design and safety. Finally, a risk assessment for the prognostics of the SB2205 bearing condition/degradation is presented.

Component	Initial HRI	Hazard Severity	Hazard Probability	Final HRI after Mitigation	Prognostics Risk (HRI)
SB3313 Timken Bearing	<i>Category IC Level 1 Unacceptable</i>	Category I Catastrophic	Category C Occasional	<i>Category IE Acceptable With Review</i>	N/A
SB2205 Roller Bearing	<i>Category IIIC Level 3 Acceptable with Review</i>	Category III Marginal	Category C Occasional	<i>Category IIID Acceptable</i>	<i>Category IIID Acceptable</i>
70351-38104-102 Pinion	<i>Category IC Level 1 Unacceptable</i>	Category I Catastrophic	Category C Occasional	<i>Category IE Acceptable With Review</i>	N/A

Table 4

Table 4 summarizes the Appendix A risk assessments. The initial Hazard Risk Index (HRI) provides unacceptable risk for the field replacement of the pinion assembly given existing resources. *Mitigating properties provided by IMD HUMS and IMC suggest if proper tooling and diagnostics are provided, the risk involved in executing the procedure is acceptable. Furthermore, the managed prognosis of the SB2205 bearing condition is also acceptable.*

**Demonstration of Diagnostic Techniques to be Used as Evidence.** Direct evidence is required for hazardous substantiation (R7). The following evidence is required:

- Seeded Fault Testing: Several fault tests were performed upon the SB2205 bearing integral race pinion spalling defect at the Navy’s Helicopter Transmission Test Facility (HTTF) (R2). Figure 3 exhibits the integral raceway, and figure 4 a trend plot of the indicator used to detect the defective component (installed between run numbers 250 and 300 Refer to figure 1 for component locations in main transmission).

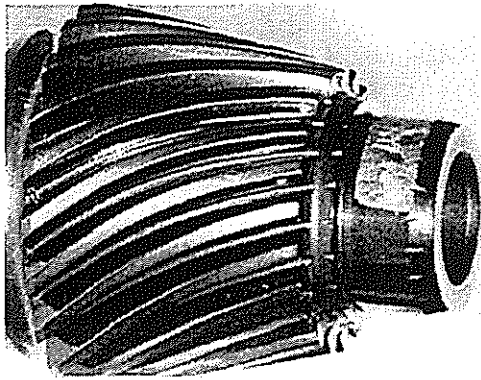

Figure 3: Spalled Bearing Integral Raceway

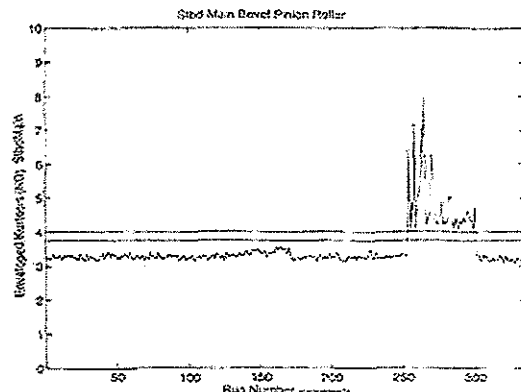

Figure 4: Bearing Defect Indicator

- Fleet History: See Appendix A Risk Assessment for fleet history of pinion assembly components.

- On-Aircraft HUMS Trails: A prototype HUMS system manufactured by B. F. Goodrich detected the first time degradation of the pinion assembly’s SB3313 bearing (R2). Figure 5 exhibits the defective bearing, and figure 6 a trend plot of the indicator used to detect the defective component. Refer to figure 1 for component locations in main transmission.

Other HIDS testing (R2) verified the B. F. Goodrich diagnostics ability to detect localized and distributed gear faults.

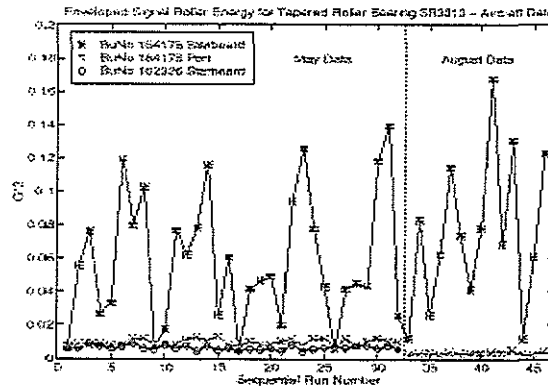
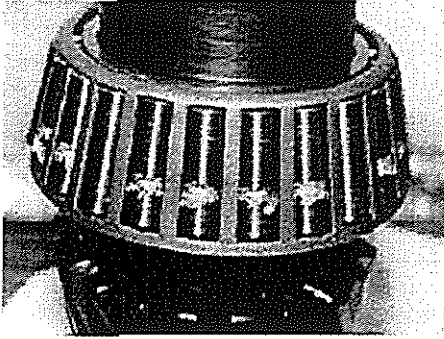

Figure 5: On-Aircraft Fault Detected During HIDS

Figure 6: On-Aircraft Bearing Fault Indicator in Red (Grey)

**Validation and Continued Airworthiness:** The authors propose the validation methodologies for this credit to be arranged by the Cognizant Field Activity. Flight criticality of IMD HMS must be defined. Continued airworthiness assurance would be via IMD HUMS data and overhaul feedback.

### Conclusions

The U. S. Navy is aggressively re-configuring its logistics infrastructure. The implementation of IMD HUMS and IMC will allow for novel means to reduce operating costs and improve readiness. The authors have presented a case study and process for the implementation of HUMS maintenance credits. Civil airworthiness maintenance credit directives are expanded upon to include cost and readiness benefits, failure mode properties, historical evidence, risk assessment, diagnostics, and prognostics. Empirical evidence has demonstrated the credit procedure and continued airworthiness via health monitoring to be fiscally feasible and low risk. Furthermore, the “managed” health (or prognostics) of this component is low risk.

### Acknowledgements

The authors wish to thank Messrs. Russ Wilson, Bob Thompson, John Johnston, John Fletcher, and Hermal Parikh, of the U. S. Navy, and LtCols. Joyce McCallister and Art Richardson of the U. S. Marine Corps for their assistance. Special thanks is due to LCDR Rick Muldoon, team leader of the IMD HUMS program.

### References

1. LCDR R. Muldoon, (U. S. Navy), “Integrated Mechanical Diagnostic HUMS” Workshop on Helicopter Health and Usage Monitoring Systems, Melbourne, Australia, February 1999.
2. Hardman, B., Hess A., and Neubert C., (U. S. Navy), “SH-60 Helicopter Integrated Diagnostics System (HIDS) Program Experience and results of Seeded Fault Testing” American Helicopter Society 54<sup>th</sup> Annual Forum, Washington D.C., USA, 20-22 May, 1998.
3. Hardman, B., Hess A., McGonigle M., Scheaffer, J., (U. S. Navy), “An Update Status for the SH-60 Helicopter Integrated Diagnostics System (HIDS) Program – Diagnostic and Prognostic Experience” American Helicopter Society 55<sup>th</sup> Annual Forum, Montreal, Quebec, Canada, 25-27 May 1999.
4. LtCol. A. Richardson, (U. S. Marine Corps), “AH-1W Integrated Maintenance Concept” 14 May 1999.
5. Horling J., Doyle J., (U. S. Navy), Moon F., (Bell Helicopter) “H-1 Upgrade Program: A Team Approach to System Safety” SAE 1997 World Aviation Congress, Anaheim, CA, 13-16 October, 1997.
6. System Safety Program Requirements, MIL-STD-882C of 19 January 1993
7. P. Legendre (Eurocopter France), “Overview of HUMS Credits” American Helicopter Society 54<sup>th</sup> Annual Forum, Washington D.C., USA, 20-22 May, 1998.

**APPENDIX A**

**Maintenance Credit Risk Assessment:**  
**Fleet Repair of Main Transmission Input Pinion Assembly**

<b>Component</b>	<b>Main Transmission Module Bearing SB3313</b>
Hazard	Improper bearing endplay adjustment during installation causing accelerated bearing wear and/or premature transmission removal or failure.
<i>Initial Hazard Risk Index</i>	<i>Category IC, Level 1, Unacceptable</i>
Initial Hazard Severity	Category I, Catastrophic. If bearing seizure occurs during operation, the inner race could spin upon pinion cutting pinion in half. Result is loss of drive from one engine and heavy secondary damage. Complete loss of drive possible if damaged pinion lodges in planetary or main bevel gear mesh.
Initial Hazard Probability	Category C, Occasional. Several instances of catastrophic helicopter mishaps have been recorded due to bearing seizure. Fleet history of this bearing failing is extremely remote (one recorded). Bearing endplay is adjusted to specification value at depot. Endplay is a critical measurement which sets the operating condition of the bearing. A unique dial indicator tool is used to measure value, and endplay adjusted by different width spacing shims. The Hazard Probability of installing the pinion and bearing assembly by inexperienced personnel without proper tooling is Occasional. Historical: Only two records of SB3313 degradation. One removed due to chips (outer raceway), second via IMD HUMS. Flight Hours Since 1989: 1,025,406.
Risk Mitigation	1. Endplay measurement is straightforward. Special tooling will be provided 2. Chip detectors are demonstrated to be unreliable for faults generated at this bearing (R2) as chip migration is impeded by oil dam. 3. Diagnostics have been directly demonstrated (R2) to be reliable for defects generated at this bearing. 4. IMC maintenance practices can provide resources (tooling and personnel) to execute this task at the Organizational (fleet) level.
<i>Final Risk Assessment with Mitigation</i>	<i>Category IE, Level 3, Acceptable with Authority Review</i>

<b>Component</b>	<b>Main Transmission Module Bearing SB2205</b>
Hazard	Accelerated wear of integral race bearing inner raceway causing chip lights and premature transmission removal. Manufacturing and installation improvements have been made but nuisance continues.
<i>Initial Hazard Risk Index</i>	<i>Category IIIC, Level 4: Acceptable with Review</i>
Initial Hazard Severity	Category III, Marginal. Inner race bearing damage has historically been detected and safely contained. Integral race design reduces hoop stresses and prevents catastrophic inner raceway failure. Some minor secondary damage to planetary system due to defect chips has been encountered.
Initial Hazard Probability	Category C, Occasional Occasional history of SB2205 bearing degradation recorded in fleet. No incidences recorded causing loss of drive. Good chip migration of defect has been encountered providing adequate warning. Historical: 27 recorded (1989-91) causing chip lights. Recent investigation found 25 of 100 pinions which entered overhaul were found to be degraded. Flight Hours Since 1989: 1,025,406
Risk Mitigation	Tooling. Required to insure integral raceway is not damaged during installation.

A HUMS Maintenance Credit Case Study

	Chip detectors are demonstrated to be reliable for faults generated at this bearing. Diagnostics have been directly demonstrated (R7) to be reliable for the detection of SB2205 bearing degradation. Maintenance Practices: IMC will serve to provide tooling and expertise to execute removal and installation of this component in fleet
Final Risk Assessment with Mitigation	Category IVC, Level 4, Acceptable
Prognostics Risk	Level 4: Acceptable. Prognostics does not increase current risk. Good chip migration has been demonstrated. Secondary damage from degraded bearing particles mitigated by 3 micron filtration, redundant oil supply pumps, and IMD HUMS diagnostics.

<b>Component</b>	<b>Main Transmission Module Input Pinion 70351-38104-102</b>
Hazard	Improper gearmesh installation (backlash) can cause accelerated gear tooth wear and premature gearbox removal/failure.
Initial Hazard Risk Index	Category IC, Level 1, Unacceptable
Initial Hazard Severity	Category I, Catastrophic Improper gearmesh installation can cause: <ol style="list-style-type: none"> <li>1. Gear tooth surface distress and chips leading to premature transmission removal.</li> <li>2. Overload of gear tooth in root bending and tooth fracture.</li> </ol> If backlash insufficient gearmesh clearances will be reduced such that insufficient cooling (oil flow) will be present and teeth will rapidly degrade driving system heat up and possibly losing tolerances (causing seizure) of bearings on pinion or mating gear potentially hazardous condition exists.
Initial Hazard Probability	Category C, Occasional. Typically, gear meshes with gross backlash errors are found during acceptance testing prior to delivery to fleet. The fleet replacement procedure would not have such a "green run" test. No history of gross backlash errors causing mishaps have been recorded. Setting gearmesh backlash is a tedious task requiring expertise. No access to the backlash shim location (gear) is present in the proposed procedure. Chance of overloading tooth in root bending fatigue is extremely remote. The Hazard Probability of installing the pinion and bearing assembly by inexperienced personnel without proper tooling is Occasional. Historical: No root bending fatigue or mishaps/aborts recorded due to gear mesh anomalies. Flight Hours Since 1989: 1,025,406
Risk Mitigation	<ol style="list-style-type: none"> <li>1. This task has been executed several times at the HTTF using special tooling And a replacement pinion with the same backlash as that being replaced.</li> <li>2. IMD HUMS/NALCOMIS parts tracking database can provide a -38104 Pinion with a desired backlash value if requested.</li> <li>3. Chip detectors are demonstrated to be reliable for gear tooth surface distress faults at this location.</li> <li>4. IMD HUMS diagnostics have been directly demonstrated (R2) to be reliable to detect localized and distributed gear tooth defects on this gearmesh.</li> <li>5. IMC maintenance practices can provide resources (tooling and personnel) to execute this task at the Organizational (fleet) level.</li> <li>6. Penalty run during check flight.</li> </ol>
Final Risk Assessment with Mitigation	Final Hazard Assessment with Mitigation: Category IE, Acceptable with authority review

## APPENDIX B

### MAINTENANCE CREDIT RISK ASSESSMENT CHART

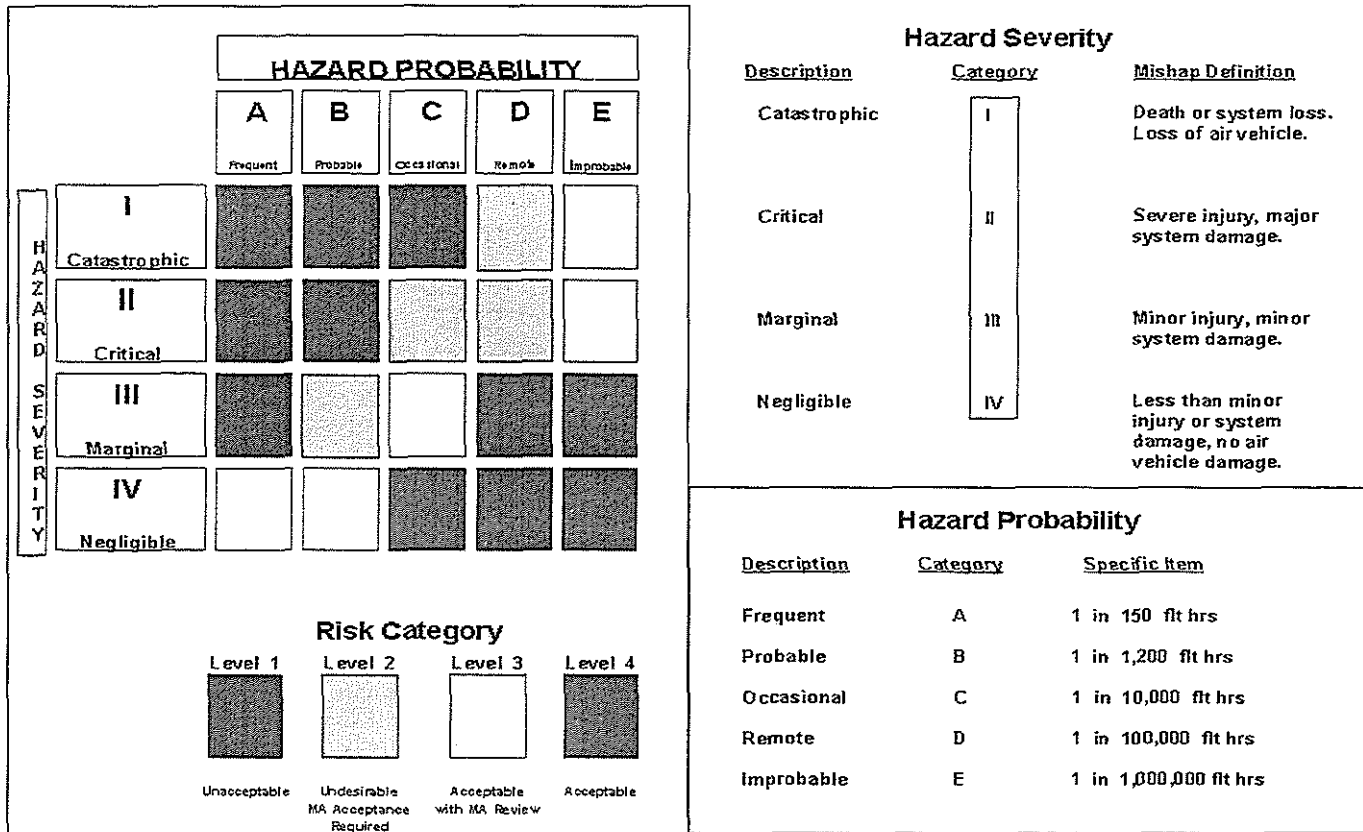

**Risk Assessment Chart Terms**

**Hazard Severity:** Qualitatively identifies the worst potential safety-related consequences, defined by personal injury, property loss, etc.

**Hazard Probability:** The probability that a hazard will occur during the planned life expectancy of the system is expressed in potential occurrences per unit time.

**Hazard Risk Index (HRI):** Represents the combination of a hazard's severity and probability of occurrence. It is used as a means to establish priority for action and mitigation.

**Risk Category:** Denotes risk level and required action for acceptance (if required).

**Risk Acceptance:** NAVAIR has acceptance responsibility for all Risk Assessments. Level 2 Category items must be authorized by Program Management. Level 3 items are recorded in the System Safety Program Plan