

THE DEVELOPMENT OF AN ENGINE AIR PARTICLE SEPARATOR SYSTEM FOR THE CH-47 HELICOPTER

Paul Stallard

Aircraft Porous Media Europe Limited

Portsmouth England

Abstract

Inertial separators incorporating miniature axial flow cyclone tubes provide a cost-effective solution to the problem of engine erosion in helicopters operating in desert and other hostile environments. The inertial separator removes dust and sand from the engine intake air and discharges it overboard continuously, providing a permanent, self-cleaning protection system. Engine air particle separator systems of this type are specially designed and developed for each helicopter type and are currently available for the majority of helicopters in production world wide.

The operating principle, design features, development, testing and performance of a unique separator system for the Boeing Helicopter Company CH-47 helicopter are described in this paper. Details are given of the basic separator module and its by-pass system, together with the mounting arrangements on the helicopter fuselage. Features of the separator electrical control system are described, including the cockpit switch and indicator panel, safety systems and monitoring devices.

Bench and flight testing were successfully completed and resulted in qualification of the separator system; the installation and performance of the separator were entirely satisfactory. As a result, the equipment has been fitted to the fleet of CH-47 helicopters in service with the Egyptian Air Force.

Introduction

Axial flow cyclone separators have been manufactured by the Pall Group of Companies under the trade mark Centrisep for more than 20 years. They have been used typically to protect gas turbine and Diesel engines and control systems from abrasive airborne contaminants. The axial flow cyclone system provides a permanent, high efficiency, non-clogging separator with no moving parts and minimum maintenance requirements.

The air entering the gas turbine engines of helicopters must be as clean as possible otherwise the engines will be worn or damaged by dust and other contaminants and their performance will rapidly deteriorate. For example, helicopters are unable to operate successfully in a desert environment without some form of engine intake protection.

Barrier filters have been used to protect helicopter engines, but the build-up of contaminant leads to a reducing power availability from the engines, with this power loss accelerating in wet and freezing conditions. The penalties are frequent filter replacement, unplanned landings and reduced engine power.

The engine air particle separator system was developed as an alternative to barrier filters. It protects engines from the harmful effects of dust and sand erosion, ice, snow and foreign object damage and salt spray fouling and corrosion (Ref.1). This axial flow cyclone separator system removes contaminant from the air and exhausts it overboard continuously using a scavenge system. Hence it provides a self-cleaning, continuously running system to protect the engines at all times.

The CH-47 helicopter has two Textron-Lycoming T55 gas turbine engines, each generating a maximum power of 3750 SHP mounted externally on the aft fuselage of the helicopter. Engine constraints determined that the protecting separators would need to be stressed structures directly mounted to the fuselage and accurately aligned to the gas turbine inlets (Ref. 2). Plate 1 shows the general view of the CH-47 helicopter with separators fitted; Plate 2 shows the starboard engine and separator. The separators also had to be moveable in order to carry out routine engine checks and compressor inspections. The separator system replaces the current all weather screen inlet configuration.

The location of the front face of the separator was tightly constrained by helicopter clearances; the forward surface of the separator is close to the tips of the blades of the front rotor; the front surface of the engine gearbox provides only minimum clearance to the by-pass mechanism and front panel.

The major design consideration was that the operator needed his fleet of CH-47 helicopters to operate in desert conditions. Without adequate protection it was known that after only 12 landings in desert conditions, compressor replacements would be necessary, incurring limited helicopter operational availability and an unrealistically high maintenance cost profile.

The design challenge presented above resulted in the development of a wide range of special features leading to a highly innovative product.

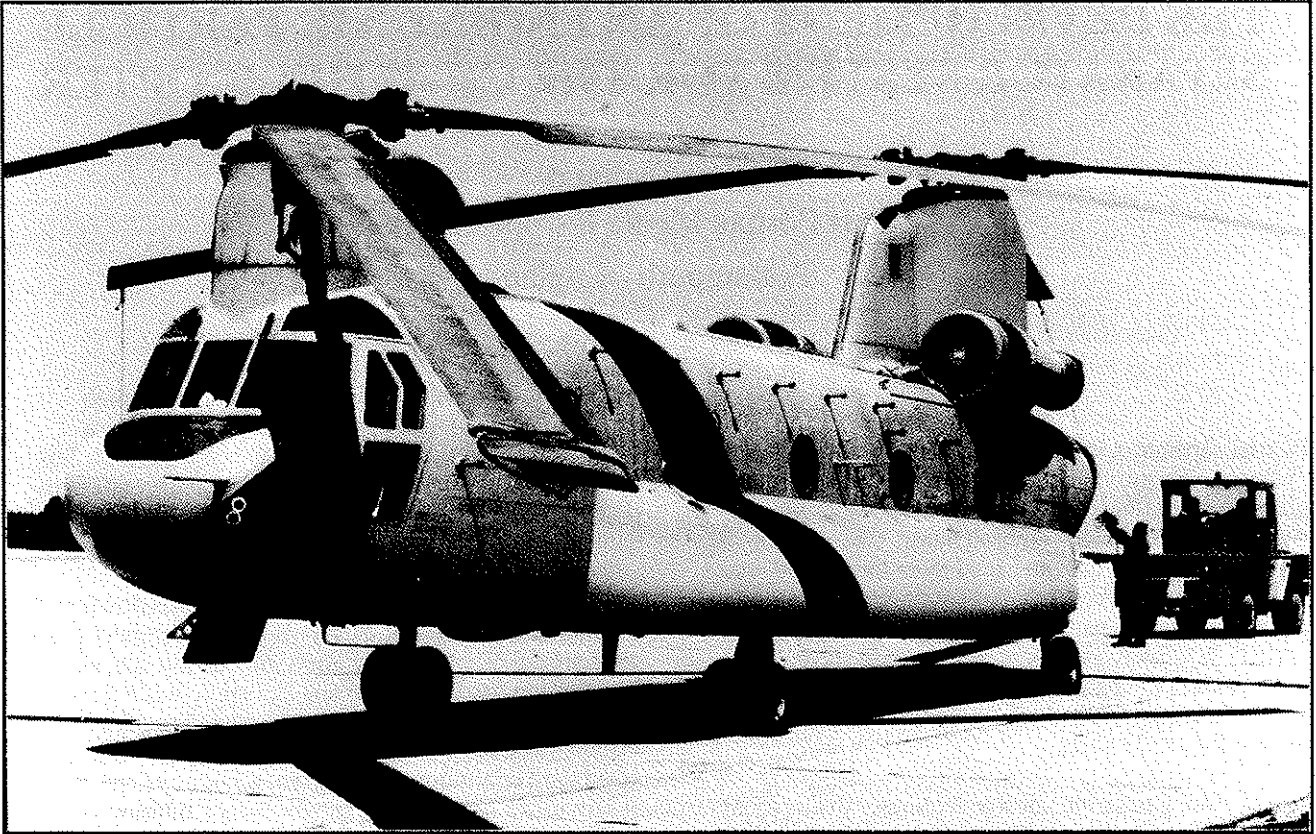

Plate 1
CH-47 Helicopter with Separators Installed

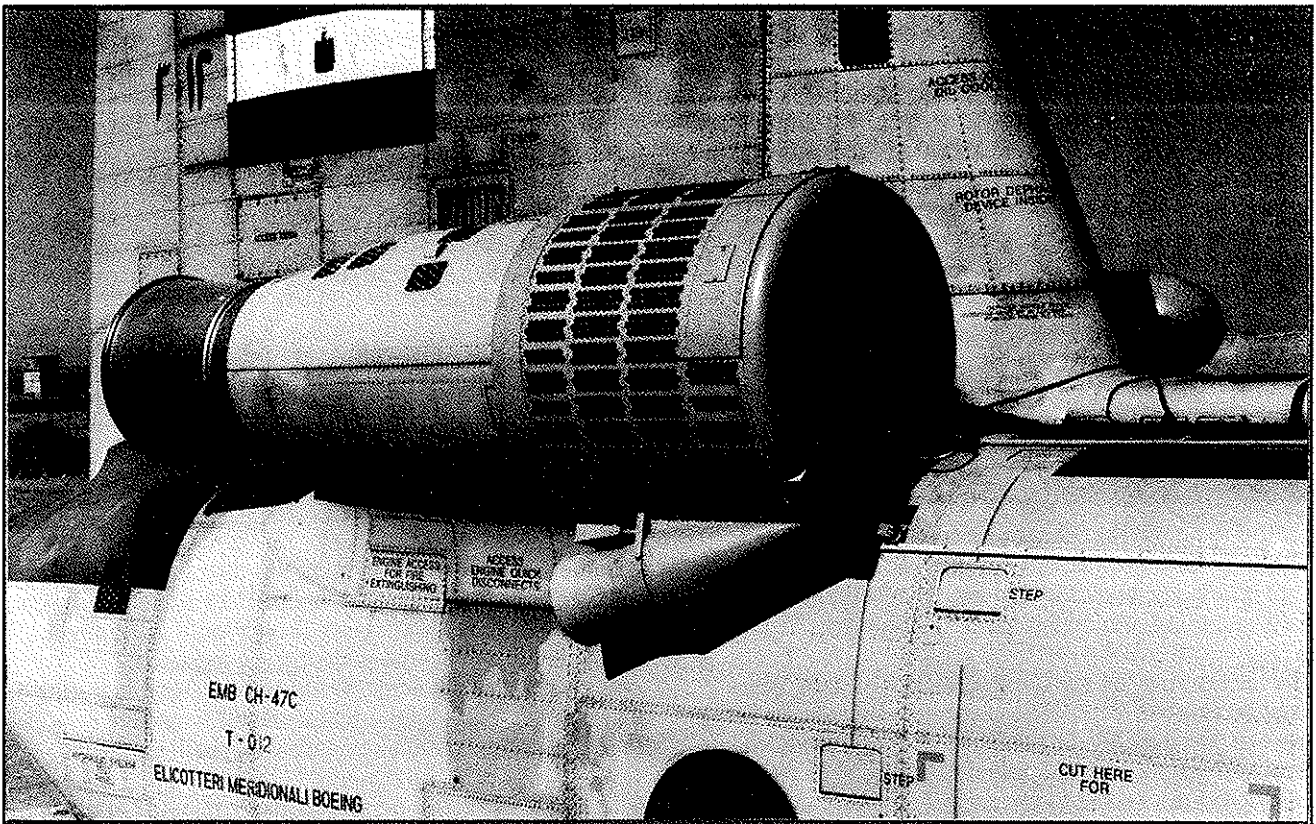

Plate 2
Starboard Engine and Separator

Operating Principle

The principle of the cyclone separator is the separation of particles from an air flow by causing them to take different routes from the air stream by virtue of their inertia. In the cyclone system described, the basic flow is axial and air entering the vortex tube is forced into a spiral flow by the fixed blades of the vortex generator. The particulate is thrown outwards to the periphery of the vortex tube by centrifugal force, and is carried away through the annular gap between the vortex tube and outlet tube together with a small proportion of the air flow (the scavenge flow). The principle is illustrated in Figure 1 which shows a typical single-stage tube configuration.

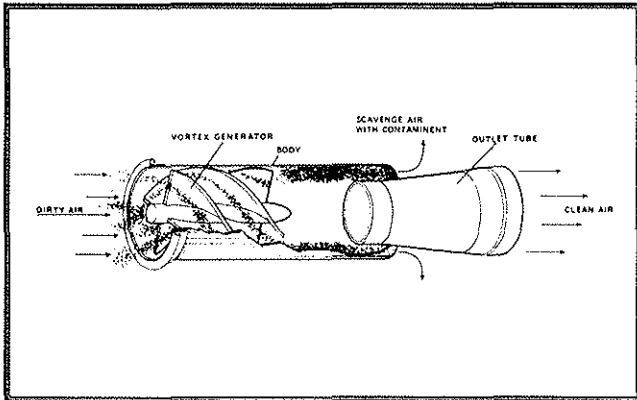

Figure 1
Operating Principle of Axial Flow Cyclone Tube

The bulk of the air flow, from which the particulate has been separated, passes axially down the centre of the outlet tube. The separated contaminant is concentrated into the scavenge air flow which is ducted away for discharge. There are no moving parts in this separator system.

To handle higher flow rates, a number of tubes can be mounted in parallel between tube plates; approximately 3200 tubes are used in each CH-47 separator module. The tube quantity and layout are optimised to provide the best efficiency of particulate separation in conjunction with pressure loss and space considerations. Separation efficiency is a function of particle size and density, air conditions, volumetric flow rate and cyclone geometry. For a given particle size, an increase in separation efficiency is normally gained at the expense of energy loss in some form, usually as an increase in pressure drop.

Design Features

General Configuration

A handed pair of separator assemblies are provided; they are cylindrical in shape with a flat forward surface. The cylindrical and front surfaces are double walled to form the separator panels into which the plastic vortex tubes are fitted, as shown in Figure 2, the vertical section through the separator. The hollow panel structure and some internal ducting form the scavenge flow system which draws the contaminant from the separator tubes.

The scavenge system is powered by an electric axial flow fan which discharges the debris downwards and rearwards away from the separator.

The separator assembly is mounted on rails which enable it to be easily moved forward to permit engine inspections. When in the aft position for flight, the separator is attached to the fuselage structure by means of four lugs into which two slide spigots and two expanding pins are fitted. The fuselage structure is locally reinforced by means of internally fitted channel sections which form bridge members between fuselage frames. The separator design was generally in accordance with the Boeing Helicopter Company specification (Ref.2).

Curved Separator Panels

Prior to this project, only flat tube sheets were produced with the result that cylindrical structures had to be built up as a series of flat panels. The separators supplied for the Super-Puma helicopter are an example of this earlier type of construction. The separators of the CH-47 were the first to make use of curved tube sheets. This innovation enabled higher air cleaner tube packing densities to be used and resulted in a structure of higher strength, greater stiffness, lower weight and enhanced appearance on the helicopter.

By development of manufacturing and assembly techniques a relationship between the radius of curvature of the panel and the quadrant angle per panel was established. This enabled a pure cylindrical structure to be produced for the CH-47 separator with 90° quadrant tube sheets.

By-pass Mechanism

The by-pass provides an emergency system to enable the engines to continue running in the event of airborne debris such as plastic sheet, paper, leaves or grass being sucked onto the separator, causing a partial blockage.

Two by-pass doors are provided per separator as shown in Figure 3. The doors are curved rectangular panels mounted flush with the outer surface of the cylindrical module when in the closed position. To open the doors, electric actuators drive the door panels radially outwards. The door mechanism includes two tubular guide rods per door, to achieve a smooth translational movement, combined with structural strength and stiffness.

The design of the by-pass system provides:-

- (a) minimum aerodynamic drag with doors open,
- (b) minimum space envelope, to avoid contact with the engine gearbox which is positioned forward of the engine inside the plenum of the separator,
- (c) ability to restore the separator pressure loss to its normal value in the event that 30% of the air cleaner tubes are blocked,
- (d) minimum weight combined with adequate structural strength and vibration resistance.

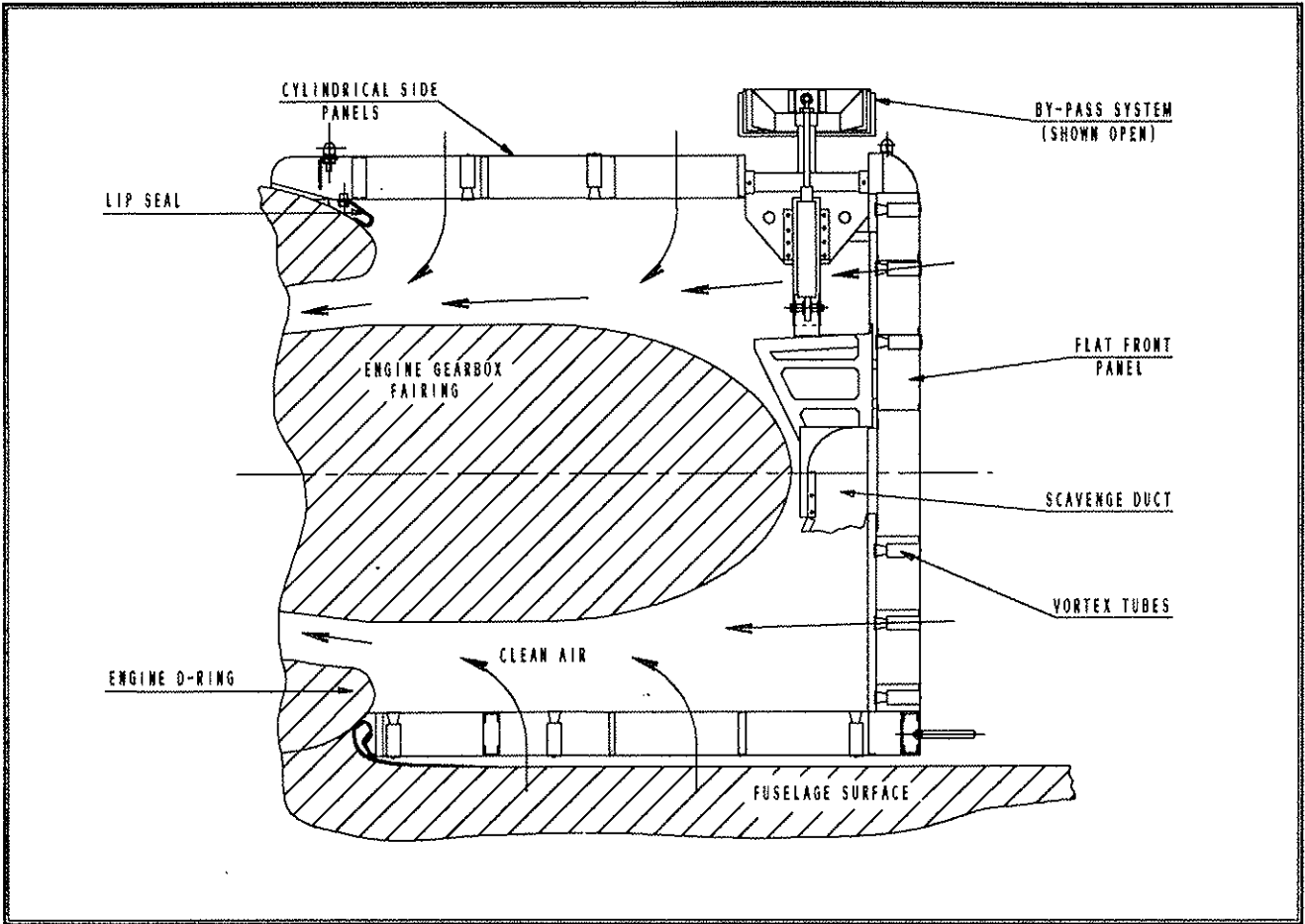

Figure 2
Vertical Section through Separator

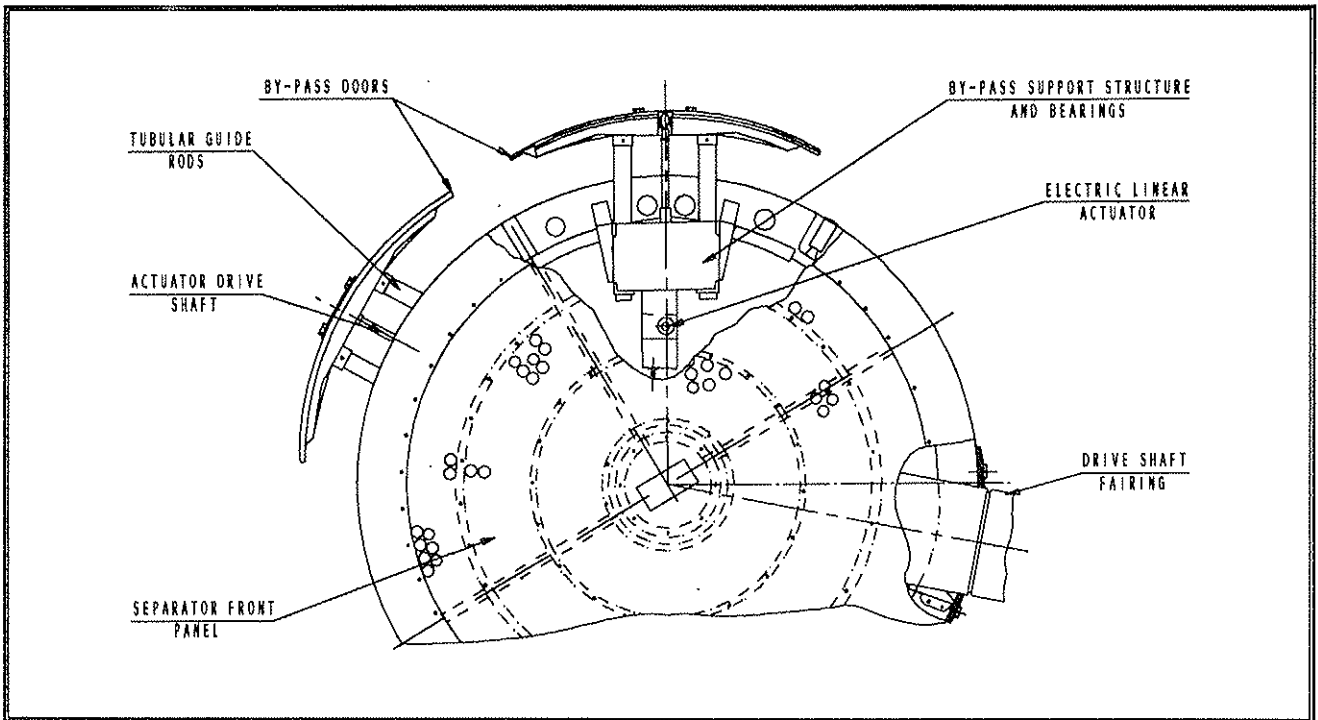

Figure 3
By-pass Doors in Open Position

Opening the by-pass doors is not recommended under any conditions except those of partial blockage described at the beginning of this section. Opening the by-pass in hover would result in a small power gain, but in forward flight the effect is negligible. In snow and icing conditions the by-pass doors must be kept closed, otherwise ice may be ingested into the engine.

Electrical Control System

The complete electrical control system, from separator to cockpit control panel, was designed, built and installed in the helicopters as part of the separator supply contract. Some key features are described below:

Scavenge Fans New scavenge fans were designed and developed for the CH-47 separator. The fans have low weight/power ratio, and are designed with an inlet guide vane configuration which results in the centre of gravity being located close to the mounting flange plane: This configuration minimises the potential problems of cantilever vibration resonances with the fan installed in the separator. Development of the inlet guide vanes and the impellor blading was necessary to meet the required flow/pressure rise relationship. The fans operate from the 200 volts, 400 Hertz, three-phase AC supply. The starboard fan and its diffuser can be seen below the separator in Plate 2.

Scavenge Fan Switching A significant safety feature of this system is the circuitry to prevent overload in the event that two scavenge fans are switched on simultaneously. Time delay relays are used such that power to the starboard scavenge fan circuit is not available until 10 seconds after the port scavenge fan has been started. In addition, the scavenge fan control circuits are linked into the helicopter bus-tie relays such that failure of either helicopter generator results in shutdown of the separator scavenge fans. These protection and safety features are considered necessary because the 80 amps starting current of each scavenge fan represents a significant proportion of the helicopter generator output. The time delay relay can be seen between the main contactors at the top of the separator relay panel shown in Plate 3.

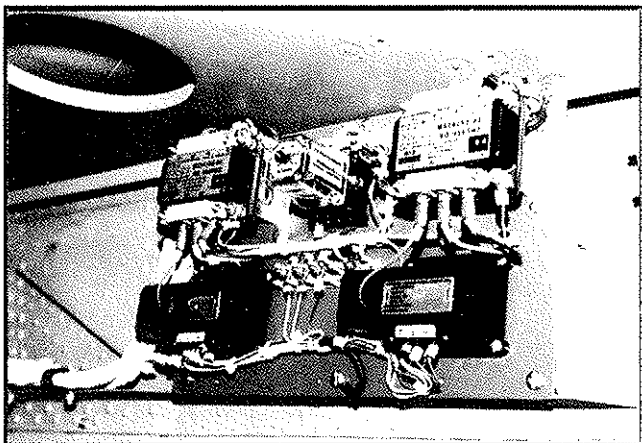

Plate 3
Separator Relay Panel

Current Sensors Prior to this project, neon indicator lamps were used to show that AC scavenge fans were operating. This was unsatisfactory because the neon lamp in fact indicated that the fan supply was live, but not necessarily that the fan was running, (or even fitted!)

The current sensor developed for the CH-47 separator senses the current in one of the scavenge fan supply cables and switches on a green cockpit indicator light when the scavenge fan current has risen above a pre-determined value. In a situation where the scavenge fan impellor shaft is broken or the impellor is severely eroded, the fan current would be too low to maintain the green indicator light and the pilot is hence made aware of a potential fan problem.

The current sensors are located at the bottom of the separator relay panel, and can be seen in Plate 3.

Abnormally high fan currents would result in fan shutdown by trip-out of the cockpit AC circuit breakers or the thermal overload breakers in the fans themselves.

Differential Pressure Indication System Each separator is fitted with a differential pressure switch which senses the pressure difference between the inside and outside of the curved panels. When the difference exceeds 10 ins. wg, the switch operates and a red warning light on the cockpit control panel is illuminated, indicating the need to select by-pass open under some circumstances.

The significant part of the development of this system was the selection of pressure probe locations; this work was carried out as part of the flight test programme in Egypt where a number of probe locations were checked in various flight modes; selection was based on those locations which were less affected by helicopter speed changes and local aerodynamic interactions between fuselage and separator.

Cockpit Switch and Indicator Panel The cockpit switch and indicator panel is shown in Plate 4.

The upper row contains the switches which operate the



Plate 4
Cockpit Switch and Indicator Panel

left and right scavenge fans, together with the green indicator lights which are powered from the respective current sensors.

The centre row of four yellow lights indicate the position of the by-pass doors; note there are two doors per separator and one light per door. From the light sequence logic the pilot can determine that full travel of the doors has taken place after switch selection to the "open" or "closed" position. The lower row contains the two red lights which are operated from the pressure switches and indicate high differential pressure across the separator: the two corresponding by-pass door selection switches are also located here.

Separator Mounting Arrangements

External Rails and Mountings As part of the mechanical installation, rails are fitted externally to the fuselage of the helicopter: PTFE slide blocks are attached to four brackets on the base of each separator module and these blocks engage on the rails to enable the separator to slide forward about 40 ins. along the rails. This gives access for helicopter engine maintenance and compressor inspections. To minimise weight, the rail and slider system is designed for ground handling loads only.

With the Centrise separator pushed back into the aft flying position, two spigots engage into brackets to provide the aft location, and two quick-release expanding pins form the forward attachment. These four mounting points provide strong attachments of the separator to the helicopter and carry the flight loads.

The rails and front mountings can be seen in Plate 2.

Helicopter Structural Reinforcements To transfer flight loads through the four separator mounting points into the helicopter structure, Aircraft Porous Media Europe Ltd designed and fitted an internal reinforcement structure inside the helicopter. It consists of four reinforced channel section longitudinal members which form bridges between existing frames located at aircraft stations 440 and 492.

The helicopter structural reinforcements inside the left fuselage are shown in Plate 5.

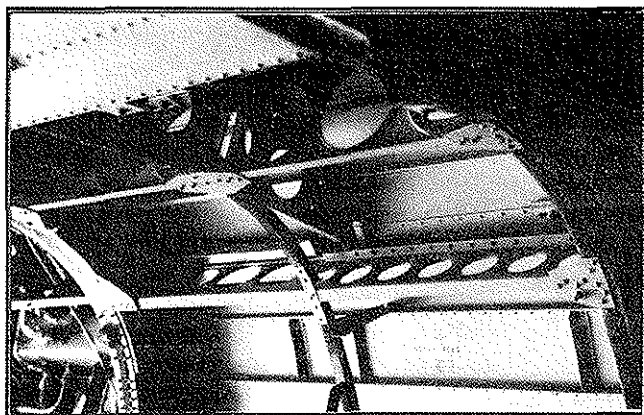

Plate 5
Helicopter Structural Reinforcements

Seal Configurations To maintain the highest efficiency of separation of debris, it is important to reduce air leakage by providing air-tight sealing at the separator interfaces.

When the separator is pushed back onto the engine intake, a flexible silicone rubber lip seal locates on the intake D-ring. This provides good sealing under all conditions of engine and separator movements due to vibration and thermal expansion. The lip seal and associated D-ring are shown in Figure 2.

The drive shaft from the engine gearbox to the rotor gearbox passes through the side wall of the separator in a fairing. Sealing at this location is achieved with a combination of silicone lip seals and foam seals fitted to a removable segment; the segment fits between the D-ring and the drive shaft fairing and is attached to the separator with quick-release fasteners.

Separator Development

Significant development work is listed in the following paragraphs:-

Dust Separation Efficiency

Development of the tube patterns and scavenge ducting system enabled the specified 91% efficiency of separation of BS1701 coarse test dust to be achieved (Ref.3).

Two full scale models of the separator were built prior to prototype manufacture and tested in a purpose built wind tunnel facility. The first model established basic flow distribution and pressure losses, and enabled refinement of the air cleaner tube patterns.

The second model was used to optimise the scavenge flow distribution in the air cleaner tubes and through the scavenge ducts and galleries of the separator, such that the dust separation efficiency could be achieved.

Flow/Pressure Loss Characteristics

Basic development of loss characteristics was carried out on the first test model, and confirmed on the second model. This development also included sizing of the by-pass doors to meet specific loss characteristics with front panel blanked and by-pass open.

Engine Intake Pressure Distortion

The presence of the engine gearbox and fairing inside the separator (Figure 2.) resulted in limited space in which to accommodate the ideal air flow distribution from the separator tubes to the D-ring intake. Various configurations of flow dividing cones were fitted inside the plenum of the separator and tested in the wind tunnel. The objects of this development programme were:

- i) to minimise engine intake pressure distortion,
- ii) to improve the balance of vortex tube flow distribution,
- iii) to obtain some benefit in forward flight from ram recovery for air entering the front panel.

The final design configuration was without a cone, and enabled the engine intake pressure distortion indices at compressor plane and D-ring to be held below those of the intake without the separator (Ref 3.). The absence of the cone simplified the internal structure and build technique of the separator, whilst introducing only a small penalty on ram recovery.

Vibration and Acceleration Strength

The prototype installation was cleared for flight by resonance search vibration testing of a bench test separator assembly. Vibration levels were monitored during the flight testing, and these recorded levels were used as a basis for the vibration endurance test of the bench test separator assembly. The same test assembly successfully passed the resonance search and two vibration endurance test programmes (Ref.3). The separator and its mountings were designed to an ultimate acceleration force equivalent to 40 g.

Bird Strike Resistance

The Centrisep separator must withstand the impacts of a 3 lb bird and a 2 ins. diameter hailstone at 125 knots on the front panel, without releasing harmful debris into the engine. Various configurations and materials were tested as model front panels, and from the results of this development programme, a final design configuration was selected. The test programme included perforated shields up to 0.25 ins. thick in aluminium alloy and up to 0.12 ins. thick in stainless steel; various tube sheet materials were also tested and the lightest cost-effective design incorporated stainless steel tube sheets without a shield.

A full Centrisep separator assembly was built to this final design configuration and passed the tests of bird impact and ice-ball impact (Ref.3). A mass penalty of 6 lb was incurred in meeting the bird strike requirement.

Sealing Configurations

The separator seal at the D-ring was of the same lip configuration as that supplied for Sea-King/Commando and Mi-8 helicopters, and hence little development was necessary.

The sealing of the segment which is fitted between separator and drive shaft fairing was more complex; several sealing arrangements were built as mock-ups before the final design was selected. A combination of silicone rubber lip seals and foam filled sections was found to give the most satisfactory sealing arrangement.

Flight Testing

Initially ground and flight testing of the prototype separator installation was carried out in Egypt by the Egyptian Air Force in conjunction with Aircraft Porous Media Europe Limited. Subsequently flight test programmes were also carried out by the Boeing Helicopter Company (Ref.5) and by the Royal Air Force.

The Egyptian test work established that the basic handling characteristics of the CH-47 were unaffected by the addition of the separators. Vibration monitoring formed an important part of this programme and accelerometers were mounted on the separators and their mountings in addition to the standard fuselage measurements; no adverse vibration resonances occurred, and the flight records were used as a basis for the bench vibration endurance tests. In-flight static pressure surveys were carried out to determine pressure losses and distributions inside and outside the separators; this work confirmed the bench test results and enabled the differential pressure switch tapping locations to be finalised. The effect of the separator on engine and aircraft performance was also determined within the limit of accuracy of the standard cockpit instrumentation. Multiple desert landings were performed to demonstrate the reduction of engine erosion with the separators fitted.

The Boeing Helicopter Company test work reported in Ref 5. determined that the engine starting and acceleration, the aircraft handling and the airframe stresses were not significantly changed when separators were fitted. The programme established the engine performance changes, the aircraft component penalties and the aircraft performance, and these are summarised in the following section.

Separator and Aircraft Performance Summary

The following performance parameters of the separator and the CH-47 installation have been established from bench and flight testing (Ref.3, 4, and 5).

Size and Mass

| | |
|---|----------|
| Diameter of separator | 34.6 ins |
| Length of separator | 35.0 ins |
| Overall height (including scavenge fan and open by-pass doors) | 51.0 ins |
| Mass of aircraft set of separators, electrical kit, mechanical kit and reinforcements | 272 lb |
| Mass of aircraft set of all weather screens removed from aircraft | 77 lb |
| Mass penalty of fitting separator system | 195 lb |

Efficiency and Pressure Drop

| | |
|---|------------|
| Rated air flow per engine | 27 lb/sec |
| Efficiency of separation of BS1701 Coarse test dust at rated flow | 91% |
| Estimated engine erosion life improvement factor (Ref.1) | 11 |
| Pressure drop at rated flow; by-pass closed | 4.7 ins wg |

| | |
|--|------------|
| Pressure drop at rated flow; by-pass open | 4.1 ins wg |
| Pressure drop of D-ring intake at rated flow | 0.9 ins wg |
| Pressure drop penalty with separator, by-pass closed | 3.8 ins wg |
| Pressure drop penalty with separator, by-pass open | 3.2 ins wg |

Engine Performance Changes

| | |
|------------------------|------|
| Power losses; in hover | 1.8% |
| at 85 knots TAS | 3.0% |
| at 135 knots TAS | 6.2% |

| | |
|-----------------------------------|-------|
| Fuel flow penalty | 1.3% |
| Electrical load for scavenge fans | 20 HP |

Aircraft Performance Changes

| | |
|---|---------|
| Cruise speed penalty | NIL |
| Maximum speed reduction at MCP | 6 knots |
| Maximum range penalty | 1.3% |
| Payload penalty; at 30nm mission radius | 900lb |
| at 100nm mission radius | 930lb |

Electrical requirements

| | |
|--|-----------------------------------|
| AC supply for scavenge fans | 200 volts 400 Hertz 3 phase |
| Starting current per fan | 80 amps |
| Running current per fan | 19 amps |
| Power consumption (total for 2 fans) | 10 kw |
| Supply for by-pass actuators, control and monitoring circuits and warning lights | 28 volts DC |

Performance in Erosive Environment

It must be borne in mind that the engine and aircraft performance changes presented above are based on "clean air" comparisons and do not take account of engine erosion effects. Figure 4 gives a pictorial representation of the engine power available in a typical desert environment, with and without engine air particle separators fitted.

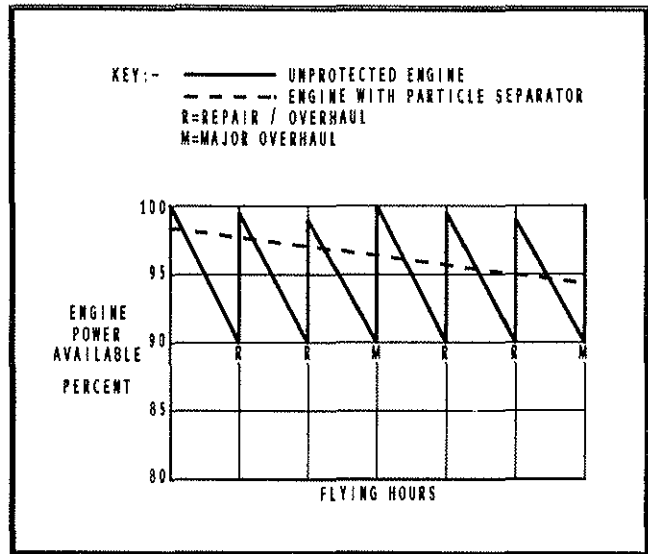

Figure 4
Effect of Erosion on Engine Power Available

The rapid erosion of the unprotected engine results in the need for frequent and costly repairs and overhauls at points marked R and M in Figure 4. With the separator fitted, the erosion rate and hence the power degradation rate, are reduced by a factor of 11 as indicated by the lesser slope of the dashed line. This factor is based on data from Detroit Diesel Allison and the US Army Research and Technology: Applied Technology Laboratories which are included in Ref.1.

The average power available with separators fitted is shown to be higher than that without separators, even though the separator causes approximately 1.8% power loss in the new engine installation. The engine overhaul periods are considerably extended with the separator fitted: This not only results in overhaul cost savings, but also enables the helicopter to operate in more hostile environments.

The benefits to the operator in terms of engine repair and overhaul cost reductions are firmly established for helicopter operation in the desert environment. The cost savings depend on the severity of the environment and are presented in detail in Ref. 1. It is likely that the cost of ownership benefits are sufficient to justify fitment of the separator system for European operation on the basis of foreign object damage (FOD) reduction alone.

Conclusions

- (a) The engine air particle separator system provides an effective means for reducing engine erosion, reducing overhaul costs and maintaining power in an erosive operating environment.
- (b) The separator achieved the specified 91% efficiency of separation of BS.1701 coarse test dust, and hence has a predicted engine erosion life improvement factor of 11 (Ref.1).
- (c) The pressure losses and hover power losses achieved were acceptable and within the specification limits (see Performance Summary).

- (d) The by-pass system functioned satisfactorily and was able to restore the separator pressure drop to normal in the event that 30% of the cyclone tubes were blocked.
- (e) The mechanical installation, structural reinforcements, mounting arrangements, and sealing interfaces proved to be satisfactory in operation.
- (f) The rails and slide mechanisms provided a simple, rapid means of moving the separator for engine inspections. A modified design of rail/slide mechanism with less internal structural reinforcements is available for CH-47 helicopters with restricted access to the internal structure.
- (g) The separator electrical system and its associated control, monitoring and indicating features were entirely satisfactory in operation.
- (h) A qualified engine air particle separator system is available for operators of CH-47 helicopters.
- (i) To obtain flight certification for operation in icing conditions and snow, it will be necessary to carry out icing tunnel tests and winter trials.

References

- (1) Stamp, J. "Engine Air Particle Separator Panels for Helicopter Engine Protection": Sixteenth European Rotorcraft Forum, Glasgow, September 1990, paper II.5.3
- (2) Boeing Vertol Company specification number 114 PS 500 entitled "Engine Air Particle Separator (EAPS)" dated June 1979.
- (3) Aircraft Porous Media Europe Limited report number QTR 1085 entitled "Qualification Testing of CH-47 Engine Air Particle Separator" dated 26 August 1987.
- (4) Aircraft Porous Media Europe Limited report number ETR 1068 entitled "Flight Trials on Centrisep units QB0289/90 for the Egyptian Air Force CH-47 Helicopter" dated 16 January 1986.
- (5) Boeing Vertol Company report number D.210-12609-1 entitled "CH-47D Engine Air Particle Separator (EAPS) Ground and Flight Test Report" dated April 1986.