

EIGHTEENTH EUROPEAN ROTORCRAFT FORUM

SP - 04

Paper No 504

**MARITIME APPLICATIONS AND HELICOPTER
TECHNOLOGY**

by

**P. N. Goddard,
Engineering Director, Westland Helicopters Ltd,
England**

and

**F. Reina
Programme and Project Director, Agusta SpA,
Italy.**

September 15-18, 1992

AVIGNON, FRANCE

ASSOCIATION AERONAUTIQUE ET ASTRONAUTIQUE DE FRANCE

MARITIME APPLICATIONS AND HELICOPTER TECHNOLOGY

by

P. N. Goddard,
Engineering Director, Westland Helicopters Ltd,
England

and

F. Reina
Programme and Project Director, Agusta SpA,
Italy.

ABSTRACT

Maritime operations have seen the helicopter gain initial entry into service, improve in capability, and become an essential element of naval and civil off shore operations. Evolving operations requirements have pushed helicopter technology such that today's aircraft possess a performance beyond the imaginations of the first designers. And this performance is still being pushed forward with the EH101, NH90 and V22 Programmes.

This paper outlines the historical development of the capability and missions of maritime helicopters, describes the current state of the art, and highlights areas where improvements can still be made.

1. INTRODUCTION

In the last 50 years the maritime applications of helicopters have been progressively expanded to meet a wide range of requirements, covering military, commercial and public utility missions. However, seven major mission areas may be identified as follows:

- Anti-Submarine;
- Anti-Surface;
- Early Warning (radar picketing);
- Search and Rescue;
- Law Enforcement;
- Amphibious Assault;
- Off-Shore Civil Operations.

This variety of tasks has been associated with the continuing improvement and extension of the capabilities of the Helicopter and of its Mission Equipment Package (MEP). This paper intends to provide a review of today's achievements and outlines a likely way forward to even more demanding and cost efficient applications by achievable and affordable product improvements. As prime examples of the European state of the art in maritime helicopters the EH101 and NH90 are briefly reviewed.

2. HISTORY OF MARITIME HELICOPTER DEVELOPMENT

The first deck landing of a rotary winged aircraft was achieved in 1931 by the United States Navy, with a licensed built Pitcairn (Cierva) C30 Autogyro. Further interest in the application of rotary winged aircraft to maritime operations continued with the trials of a Cierva C30 Autogyro for the Italian Navy, aboard the cruiser Fiume in 1935, and later in the year by Royal Navy (RN) trials aboard HMS Furious, but neither the Italian or Royal Navy progressed with the procurement of a rotary wing fleet. It was left to the German Navy and the United States Navy (USN) to inaugurate the operational service of the helicopter during the war.

In 1942, the German Navy placed an order for 1000 Flettner Kolibri helicopters, to be used for submarine spotting duties aboard cruisers and

destroyers. The Flettner Kolibri was a small, single seat helicopter, utilising the side-by-side intermeshing rotor configuration, later adopted by Kaman in the US. However, production was curtailed at the end of the war, and only a couple of hundred saw operational service. At the same time, the German Navy was also introducing Focke-Achgelis autogiros to some U-Boats to extend their horizon for the spotting of surface ships!

Meanwhile in the United States, production was underway of the Sikorsky R-4, a production version of the VS-300, which entered service in 1943 with the USN.

The first helicopter squadron outside the US was 705, which was a Royal Navy trials unit with Sikorsky R-4's. This was followed by the first operational squadron flying R-4's and R-6's, and in 1950, the Royal Navy received it's first significant increase in operational capability with the introduction into service of the S-51 Dragonfly. As with most helicopters of the time, the S-51 was mainly restricted to air-sea-rescue or plane guard duties, escorting aircraft carriers during flight operations.

Two years later, the Royal Navy started Anti-Submarine Warfare (ASW) operations with the introduction of Sikorsky built S-55's, complete with AN/AQS-4 dipping sonar. These were followed into service by Westland built Whirlwinds, which in 1955 were trialed as minesweeping aircraft, but lacked the power and endurance to be viable.

In Italy, the Navy received their first helicopters in 1956, which were Agusta-Bell Model AB47G's. These were used mainly in a support role, providing the first experience of operating helicopters from ships.

In the same year, the Whirlwind was used as an amphibious assault helicopter, during the Suez Crisis. The Royal Navy also received it's first true ASW helicopter in the form of the Whirlwind HAS Mk7, which was capable of carrying an active dipping sonar as a "hunter" and depth charges or a homing torpedo as a "killer". At this time, the USN was bringing into service the SH-34 Seabat, as an ASW and utility helicopter. The basic S-58 design, of which over 1000 have been built, and saw service with the United States of America, Italy, France, Germany, Belgium, Netherlands, Canada, Brazil, Argentina, Chile and Thailand, was also developed into the Westland Wessex for the United Kingdom and other countries.

The following year, a major milestone occurred with the issue of the specification for what was to become the SH-3 Sea King. This helicopter was to be the first truly capable 'hunter/killer' helicopter, and marks a significant step forward in maritime helicopter development, and will be described in more detail later.

In 1959, the Italian Navy expanded its capability with the addition of further AB47J's and the arrival of the SH-34J ASW helicopter, with AN/AQS-4 dipping sonar and two Mk44 torpedoes.

At this time, interest in the UK was moving to a small helicopter suitable to operate off a small ship, such as a frigate, destroyer or corvette. During 1959 to 1961, trials were undertaken into a range of deck handling systems, such as decklocking systems and undercarriages. These trials led to the design of the undercarriage used on the Westland Wasp.

In 1961, the Royal Navy received into service the Westland Wessex Mk 1, which ranks as the first turbine powered helicopter in service. However this single engined variant was still limited to a 'hunter' or a 'killer' role.

The following year, the USN received it's Sea Kings into service, marking the arrival of a true 'hunter/killer' capability. The SH-3A was capable of carrying homing torpedoes and an improved sonar, the AN/AQS-10, which could sweep 360 degrees in one minute (as opposed to five for the AN/AQS-4). This sonar in conjunction with a doppler radar, a radar altimeter, a sonar coupler and an improved Automatic Flight Control System (AFCS), provided a 24 hour capability. In the same year, the USN also entered into service the first Kaman Seasprite UH-2A's, which were designed to operate from small ships and undertake a wide range of duties, such as utility, transport, Search and Rescue (SAR), casualty evacuation (CASEVAC), reconnaissance, communications and relay; they were not used for ASW or Anti-Surface Vessel (ASV) in their initial versions.

In 1963, the Westland Wasp entered service as the first small ships helicopter, qualified for operation from frigates and small patrol boats. Capable of ASV or ASW prosecution, it could carry a pair of Mk 44 torpedoes, depth charges or AS-12 missiles. With no on-board detection capability, it was vectored to a target by the ship or another equipped helicopter. This was followed in 1964 by the Westland Wessex Commando, the first twin engine helicopter to enter service with the Royal Navy.

In the same year, the USN and the US Marines (USMC) received the first of their tandem rotor CH-46 Sea Knights. These were used by the navy as large utility helicopters, for ship-to-ship lifting of supplies and ammunition etc. The USMC adopted this helicopter as their primary amphibious assault helicopter for carrying troops ashore, it providing a superior capability (range and payload) than the CH-34 Choctaw.

Also in 1964, the Italian Navy received its first turbine powered helicopter, the AB204 ASW, developed from the basic Bell airframe to incorporate an AN/AQS-13 dipping sonar and two Mk44 torpedoes.

In 1967, the CH-46 was supplemented by the bigger CH-53 Stallion (or Super Jolly Green Giant in US Air Force service) which entered service with both the USMC and USN. The CH-53 has the capacity to carry an additional 12 troops (up to 38), but more importantly it has the size to carry small vehicles and guns internally.

Also in 1967, the Royal Navy received its first all weather hunter/killer helicopter, in the Wessex Mk 3. This aircraft carried an Active Dipping Sonar (ADS) and two torpedoes, and to bestow an all weather capability, had a search radar and a sophisticated AFCS, providing an autopilot with auto-hover and auto-transition modes. This provided a significant step forward, but was soon superseded three years later by the arrival of the Sea King.

The Sea King, in all its forms, is justifiably the most successful naval helicopter, being licensed built in the UK, Italy and Japan, and in service with some fifteen maritime forces. The Italian Navy and the Royal Navy Sea Kings became operational in 1970, the RN variant having the Plessey Type 195 sonar, equivalent to the AN/AQS-13, and considered to be one of the most advanced sonars of its time. The RN operates the Sea King as an autonomous submarine hunting unit, a philosophy developed through the Whirlwind and Wessex series, and hence has a comprehensive suite of sensors and weapons. The Italian Navy adopted the SH-3D variant of the Sea King, and also developed it into an ASV aircraft by fitting it with an advanced radar and long range anti-ship missiles. Meanwhile, in USN service, the Sea King had evolved from the SH-3A basic ASW helicopter, operating as an extension of the ship, where control of the mission resides (this philosophy being continued in the LAMPS series), through a series of developments to the SH-3D, with greater power and

an AN/AQS-13A ADS, and on to the SH-3G/H family. This family is a range of multi-role shipborne helicopters, with improved ADS (AN/AQS-13B), sonobuoys, Magnetic Anomaly Detector (MAD) and improved torpedo systems, a search radar for the anti-ship-missile detection role, and a role change capability to undertake utility and SAR missions. Other versions of the Sea King have been used for VIP (Presidential) transport and minesweeping, the latter RH-3A's providing the initial equipment for the West's only helicopter minesweeping squadron, HM-12, in 1964, before the heavier RH-53D Sea Stallion became available in 1972 (the Soviet Navy has used Mi-4's and Mi-14's in this role).

At the same time as the Royal Navy was receiving its Sea Kings, the French Aeronavale (Navy Air Arm) was receiving its SA321 Super Frelon's, as a large carrier borne ASW helicopter, equipped with dipping sonar and search radar, and unique at the time by having three engines. These aircraft replaced their earlier SH-34's, and have had their capability expanded to encompass ASV, fitted with a nose radar and Exocet missiles, amphibious assault operations, general transport and Vertical Replenishment (VERTREP).

Also in 1970, the Italian Navy trialed two Agusta A106 single seat helicopters. An extremely small helicopter, they were capable of operating from the smallest ships, but could carry two torpedoes to a target relocated by sonobuoy and a UHF data link system. The trials however were not successful, and this operational approach was later abandoned.

The 1970's saw an increase in the offensive capability of helicopters against surface vessels, with trials of Sparrow and Sidewinder from a Kaman Seasprite in 1972, and clearance trials of the Exocet from the Westland Sea King in 1976.

In 1971, a new role was added to arsenal of naval helicopters, with the adoption of the AH-1G by the Spanish Navy and the development of the twin engine AH-1J for the USMC. Spain put the Cobra to use as an anti-ship helicopter (and primarily land based), but the USMC use their Cobra's in the offensive role against ground targets and in the escort of their large assault helicopters. It was specifically for the USMC that the range of twin engine Cobra's were developed.

1973 saw into USN service the LAMPS I helicopter, a Light Airborne MultiPurpose System, providing a helicopter borne extension of the ships

sensors. Based upon the Seasprite SH-2D, it possessed sonobuoys, radar, MAD and torpedoes. When development of the LAMPS II began, the large increase in the avionic systems required quickly outgrew the Seasprite airframe, and the programme was cancelled, to be replaced by LAMPS III based upon a larger airframe.

In 1974, the Aeronavale brought into service the *Alouette III*, both as an ASW helicopter, with a MAD bird and a Mk44 torpedo, and later as an anti-ship helicopter with two AS11's or AS12's, with a stabilised sight. Following the introduction of the Lynx, these aircraft have continued to serve in support roles.

In 1976, Italy received the AB-212ASW, for ASW and ASV operations, and two years later, the Lynx entered service with the Royal Navy and the Aeronavale. Both of these helicopters are designed for a multi-role capability and to operate from small ships. The AB-212ASW maintained the basic skid type undercarriage, combined with mooring points for securing to a ships deck, but is equipped with a dipping sonar, a 360° radar, and torpedoes or anti-ship missiles. This aircraft has been adopted by many European navies, including Spain, Greece and Turkey. The Lynx follows on from the Wasp, and used the experience gained with undercarriage and decklock systems, which combined with its semi-rigid rotor, bestows the Lynx with outstanding stability on moving ships decks. In RN service the Lynx is primarily used in the ASV role, using its radar and Sea Skua missiles, but other services, including French, German, Dutch, Norwegian and Danish, use the Lynx for ASW (with an ADS and torpedoes), utility duties, fisheries protection and SAR.

The requirements of the USN and USMC for an even more capable transport helicopter, led in 1981 to the entry into service of the CH-53E Super Stallion, the most powerful helicopter developed in the West. Capable of carrying 55 equipped troops, it is also used by both services for the recovery of downed aircraft, being able to lift the F-14 Tomcat and A-6 Intruder.

After over ten years in service, the RN Sea King's received a major boost in capability with the arrival of the Mk 5, which now had sonobuoys, improved acoustic processing (LAPADS), MAD and a longer range radar. The following year, the UK became involved in a dispute over the Falkland Islands, and in the ensuing conflict, naval helicopters played a crucial role in ASW, ASV, SAR, CASEVAC and

VERTREP. One particular outcome from this conflict was the formation of the world's first helicopter Airborne Early Warning (AEW) squadron, using modified Sea King Mk 2's, in 1984.

In 1983, the LAMPS III entered service, as a medium size multi-purpose helicopter, equipped with sonobuoys, acoustic processing, MAD, torpedoes, a long range radar and a sophisticated Electronic Support Measures (ESM) suite. However, its most notable feature is its high performance data link, connecting its systems to the ships mission control centre allowing the ship to conduct close quarters ASW up to 100 miles away, and to operate Harpoon anti-ship missiles with the LAMPS III providing Over The Horizon Targeting (OTHT). Another feature of the aircraft is the hauldown RAST deck landing system, where a cable from the ship is attached to the aircraft to stabilise as it lands and to secure it upon landing. This naval variant of the Black Hawk has been developed into other variants for ADS operation (CV Helo), SAR and Coast Guard Operations.

In 1987, the USMC and USN received major upgrades in their capability, with introduction into service of the AH-1W Super Cobra and the MH-53E Sea Dragon respectively. The former, with a significant increase in power for operations under hot and high conditions, is used for escort, fire support, anti-armour and anti-helicopter operations, using a range of weapons from Folding Fin Aerial Rockets (FFAR's), TOW and Hellfire to AIM-9 Sidewinder and Mavericks. The Sea Dragon is the latest mine sweeping helicopter, in service with the USN and the Japanese Maritime Self Defence Force. The most notable feature of this variant over other H-53E's is the very large sponsons, which contain nearly 1000 gallons of fuel to provide a long mission endurance.

In recent years there has been an increase in the use of helicopters in paramilitary roles, such as drug busting, fisheries protection and environmental policing. In the US, responsibility for such operations falls to the US Coast Guard (USCG), operating HH-65A's (Aerospatiale Dauphin) and HH-3F Pelican's (Sikorsky S-61). These aircraft are fitted with secure communications packages and the HH-3F with Forward Looking Infra-Red (FLIR) and a video recording capability. Both can operate at night, flying blacked out on Night Vision Goggles (NVG), in order to reduce detection. The aircraft then track vessels and coordinate the eventual boarding by patrol boats or land forces.

Similarly, the Norwegian Coast Guards' primary role is surface surveillance and fishery patrol within the Norwegian economic zone out to 200nm, with secondary roles of Search and Rescue, Environmental Surveillance and Police assistance, operating 6 Mk 86 Lynx's. The Lynx's operating environment provide their greatest challenge. In winter they can be operating in permanent darkness and spend a majority of the flying in Instrument Meteorological Conditions (IMC). Bad weather is a problem in the arctic areas with fog, snow showers, high winds and temperatures of -26°C , and frequent icing conditions.

In Japan, the Maritime Safety Agency is responsible for the protection of life and property and maintaining security at Sea, and performs a number of additional functions, including surveillance and control of foreign fishing, marine pollution and marine traffic, search and rescue duties and oceanographic research. The agency operates a large number of aircraft, including Bell 212, Bell 206B and Hughes 369 HS.

In Canada, the size of the country provides a significant challenge, both to the SAR services and their equipment. The area of responsibility covers an area from 30° west to 145° west and basically from the 49th parallel to the North Pole. This encompasses some 20 million sq km of territory of which 10 million sq km of land and freshwater and 10 million sq km of ocean. There are four basic environments that Canadian SAR forces operate in: Marine, Mountain, Inland and Northern. These present different challenges from high wind, high sea states and poor visibility to high mountain, with icing, wind shears and temperatures that range from -47°C to $+30^{\circ}\text{C}$. The Canadian SAR service has been operating the Labrador (CH-113) since 1963, but they lack FLIR, Search Radar, auto hover and an engine out capability. It is intended that these aircraft will be replaced by the New SAR Helicopter (NSH), a derivative of the EH101.

In comparison, the US Air Force (USAF) operates MH-53J's in the long range SAR role. With a hoist and aerial refuelling probe, it makes an ideal platform for long endurance rescue missions, the main limit to the aircrafts' range being crew fatigue. The aircraft is operated by a crew of six and is augmented by 2 pararescue men.

Helicopters are used in the offshore oil and gas exploration and exploitation industries for ferrying men and light stores between land and offshore platforms, and between platforms. The main areas

of operation for offshore oil and gas production are The North Sea, the Gulf of Mexico and the Persian Gulf with other operations taking place off Australia, Canada, Italy, Nigeria and the islands of the Western Pacific, Malaysia etc. Most of these are based close to shore up to a distance of 100 miles, with the exception of the Gulf of Mexico at 150 miles and moving out, and the North sea with distances of up to 280 miles.

In the Gulf of Mexico and the Persian Gulf, the operators tend to be local, operating small aircraft such as 212, 412, S76 and Jet Rangers etc. The aircraft tend to operate around the hot weather, in mornings etc, to avoid any hot weather performance problems.

In the North Sea the operators are the bigger companies, for example, Bristow, Bond and British International Helicopters (BIH), operating the Super Puma, S61 and some Dauphins, and on the Norwegian side there are two main operators, Helikopter Services and Braathens, who operate Super Pumas, S61 and the Boeing 234. The main problems in the North Sea are the poor weather and high winds.

In summarising we can see that helicopters have had a very successful history in fulfilling many maritime operations, starting from the limited plane guard duties, through ASW and ASV, to troop transport, escort, AEW and minesweeping operations. The associated technical improvement in helicopter capability is shown Figures 1 and 2. Figure 3 shows the growth in aircraft numbers (those used in figures 1 & 2), by the end of each decade and also shows the shift in roles they perform. The flexibility of the helicopter is now making its mark in paramilitary operations, policing shipping lanes, monitoring the environment, controlling smuggling operations and of course SAR. Civilian operations are still dominated by offshore oil exploration and support, and it can be foreseen that such operations will not only continue, but expand to longer ranges and under increasingly adverse conditions.

Let us now review the state of the art with the EH101 and NH90 European helicopter programmes.

3. THE EH101 : MERLIN

General

The EH101 is an Anglo/Italian collaborative project which has been designed from the outset as a multi-purpose helicopter to meet the needs of naval, civil, tactical transport, and commercial utility customers. The design concept is to provide a common vehicle which is optimised for particular roles by the addition of variant specific attributes.

The EH101 project thus takes the form of an integrated programme which has resulted in the development of the following aircraft:

- ASW/Anti-Surface Surveillance and Targeting (ASST) aircraft for the Royal Navy, Italian Navy and Naval Export Customers.
- Military Utility/Tactical Support Helicopter.
- Commercial Utility Helicopter.
- Civil Passenger Transport Aircraft

This integrated programme brings many advantages. Naval and military versions benefit from the long life characteristics and bulk load carrying capability demanded by commercial operators who, in turn, also benefit from power, high agility and airframe durability needed in the battlefield and small ship environment.

The naval aircraft are configured to provide an extensive ASW/ASV capability when operating autonomously or with a Towed Array Frigate. In the primary role configuration, EH101 can carry both ASW weapons and air to surface missiles in addition to the extensive mission suite. The aircraft is also equipped to carry out secondary roles such as CASEVAC, SAR, and VERTREP etc.

Operation of the civil helicopter in the North Sea environment is, in many aspects, as taxing as the naval aircraft. The EH101 capitalises on these common needs with full ice protection, Instrument Flight Rules (IFR) capability and the flying characteristics necessary to operate from ships, rig platforms and shore bases in all weathers. Typically, EH101 can carry 30 passengers and baggage at 150kts over a range of approx 430nm. Alternatively, the hydraulically operated rear ramp door facilitates disposable loads of up to 11800lbs

and the carriage of large bulky items of equipment onto restricted landing decks of oil rigs and support ships.

The ramp door also provides for the rapid deployment of stores and light vehicles when configured as a Tactical Support Helicopter. Up to 30 combat equipped troops can be carried with rapid conversion to logistic support or casualty evacuation roles.

The EH101 is also ideally suited to satisfy the requirements for AEW. The aircraft has extensive cabin space for operators consoles and electrical power and space allocation for Radar, Electronic Support Measures (ESM), Electronic CounterMeasures (ECM), Data Link and a comprehensive Communication suite. Studies/proposals are currently being prepared for an Italian AEW variant and, in the UK, the EH101 could replace AEW Sea King aircraft.

Although provided with twin pilot controls, the aircraft, in the ASW configuration, is designed for Single Pilot plus Tactical Operator (Tacco) and Sensor Operator (Senso). The general arrangement of the aircraft, shown in Figure 4, provides a sound proofed booth for the Tacco and Senso in the forward cabin area and ADS and sonobuoy dispensers in the rear cabin. Two torpedoes are carried on each side of the aircraft, and the 360⁰ radar is mounted aft of the nosewheel.

Ship Operation

The EH101 has fully automatic tail and blade fold which gives stowed dimensions compatible with operation from ships currently using the SH-3. The wide track (4.5 m) undercarriage and low centre of gravity, provides for excellent stability on deck, which combined with the automatic deck handling system, negative main rotor thrust, and high tail rotor authority, allows operation from the decks of small frigates in wind and sea conditions well in excess of previous generation aircraft.

Safety

The EH101 is equipped with three engines plus an Auxiliary Power Unit (APU), providing considerable redundancy in terms of safe continued flight following an engine failure. This reverses the trend with twin engined helicopters where the loss of an engine en route normally defines for Civil Operators the Safe Weight at which the helicopter

can fly. The Navel Customer can take further advantage of the performance capability in the engine out case, by conducting long range endurance roles which are dominated by cruising at altitudes in excess of 5,000ft with one engine shut down

EH101 is equipped with a comprehensive Health and Usage Monitoring System (HUMS) which encompasses all aircraft systems. Health monitoring of engines and transmission components will detect failures well before they can impact serviceability or safety and a Power Performance Index for the engines is also provided.

Usage monitoring is used to determine the proportion of rated component life or fatigue life remaining with due allowance for operational effects. Maintenance is "on-condition" instead of by scheduled overhaul. Status monitoring provides indications of the serviceability status of the systems and all the information is logged for post flight maintenance purposes.

Long life redundant structure and systems are provided for improved safety. The three engines, which provide increased power margins, are positioned so as to avoid any simultaneous damage.

The rugged airframe incorporates multiple load paths and extensive use is made of composite materials to reduce weight and improve damage tolerance and fatigue characteristics. Multiple load paths are also provided in the main rotor head for both centrifugal and flight loads.

Composite main and tail rotor blades provide high tolerance to accidental or ballistic damage and reduce maintenance requirements. The advanced aerodynamic design incorporating swept tips provides for substantially increased efficiency compared to conventional blades.

The gearbox has dual lubrication systems but can also operate following loss of oil for 30 minutes. The gearbox mounting struts are also tolerant to strut failure.

Extensive redundancy is built into the electrical and hydraulic systems, and avionic systems such as the AFCS, Electronic Instrument System and the Aircraft Management System.

The undercarriage is capable of absorbing descent velocities up to 12ft/sec without deformation, and flexible fuel bags and frangible self sealing

couplings are employed in the fuel system. Automatic or manually initiated flotation bags for stable buoyancy, together with other safety features, such as six emergency exits and full anti-icing provisions on windscreens, engine intakes, tail rotor blades and de-iced main rotor blades, provide increased safety in over water operations.

Vibration Environment

The EH101 incorporates an Active Control of Structural Response (ACSR) system, which utilises microprocessor controlled actuators, mounted in the gearbox struts, excited in anti-phase to the vibration forces monitored at various points throughout the structure (shown in Figure 5). The low level of vibration achieved reduces structural fatigue, and improves crew comfort. Vibration levels are less than 0.05g and, since the system is "self-tuning", this level is achieved throughout the speed range of the aircraft.

Avionic Systems

The Avionic System is fully integrated and configured around two hierarchical dual redundant Mil-Std-1553B data busses as shown in Figure 6. The comprehensive airvehicle avionic systems are controlled by an Aircraft Management System and consist of an Autonomous Navigation and Satellite Navigation Suite, all digital AFCS, an Electronic Instrument System, and a full military Communication System.

The duplex Aircraft Management System provides the basic avionic system processing for functions such as area navigation, condition monitoring, performance calculations, maintenance and operator interface. The latter function is achieved by means of a multi-function Control Unit fitted at each crew station.

The navigation suite provides the navigation data to the required accuracy necessary to meet the demanding ASW and ASV/OTH roles. Particular attention has been paid to the need for in-air alignment following take-off from a moving deck. Primary operating modes are Global Positioning System (GPS) and Doppler/Inertial with reversionary capabilities provided by Attitude and Heading Reference System (AHRS), and Air Data.

The all-digital Automatic Flight Control System provides the comprehensive Autostabiliser (ASE) and Autopilot functions plus hover trim control and

cable hover modes for the Active Diving Sonar. The ASE has extensive redundancy to tolerate multiple failures. A first failure does not require pilot intervention and a second failure provides up to 6 seconds intervention time for the pilot to assume control.

The Electronic Instrument System (EIS) consists of three Symbol Generators, three Display Mode Selectors and six 7" x 6" colour CRT Displays which provide the flight, navigation, and the engine and transmission displays. The EIS can provide all essential information following two major failures. In addition, independently driven stand-by displays and a set of conventional flight/navigation instruments are provided. The cockpit layout has been extensively simulated to optimise the design around the man machine interface and to minimise crew workload.

The naval aircraft has an extensive mission sensor fit controlled by the Mission Computer System and interfaced to the crew via Tactical Displays and Control Suite. The Mission Sensor fit contains state of the art systems for active and passive sonobuoys, Dipping Sonar, Radar, and Electronic Warfare (EW) Systems. The Mission system man-machine interface has also been subject to extensive simulation using representative scenarios and working in "link mode" with the cockpit simulator.

Integration of the Air Vehicle and Mission Avionics provides an optimum capability for ASW operations. For example, significant numbers of target tracks can be set up and maintained using multi sensor data, and sonobuoy patterns or sonar dip cycles implemented automatically. Weapon deployment can also be carried out automatically using release points generated by the tactical system assigned as AFCS fly-to points.

The airvehicle attributes, system architecture and Mil-Std-1553B data bus provide a comprehensive expansion capability and flexibility to accommodate additional enhancements or to reconfigure and undertake roles such as AEW, Mine Countermeasures, or other amphibious operations.

The EH101 entry into service will be backed by one of the most extensive flight development and maturity programmes ever planned for a helicopter. The nine aircraft, 3750 hour development phase is supplemented by an additional 6000 hours of maturity flying. Throughout each stage of the programme, Failure Reporting and Corrective Action System (FRACAS) have been implemented

and reliability growth closely monitored. The flying activity is closely supported by an extensive rig and ground test programme for all major components plus the facilities for testing and qualification of individual items of equipment and materials.

4. THE NH90 : NATO FRIGATE HELICOPTER (NFH) VARIANT

The NH90 helicopter provides a significant example of the state of the art for naval helicopters from several points of view, with reference to both its design and its programme. The programme is representative of recent European aeronautical developments as it is an international collaborative effort, connecting four nations (Germany, France, Holland and Italy) and four companies, some of which are often competitors in other programmes, but taking advantage of the large wealth of differing expertise of the participating companies. A general arrangement of the aircraft is shown in Figure 7.

The main technical advantage of collaboration is the reduction of cost and of technical risk for the development phase, while later Rationalisation, Standardisation and Interoperability (RSI) will certainly be an important asset for mission effectiveness of the helicopter in service.

The NH90 NFH, exhibits a high level of commonality with the Tactical Transport Helicopter (TTH) variant developed for other services of the four Nations. The TTH possesses reduced radar and IR signatures, passive and active self-protection kits, night vision capability and agile flight handling characteristics, which provide effective assets for maritime missions such as armed surface surveillance and coastal patrol.

The NFH variant will also have an unusually large range of alternative configurations, due to differing national requirements for weapons and sensors. For instance, the French Navy will employ a long range anti-ship missile, while others have selected a smaller weapon; both systems will be qualified, and therefore will be readily available for possible configuration changes.

Efforts to maximise affordability have resulted in an intentional minimisation of technical risks likely to cause delay or increased costs. Therefore proven technology for the vehicle and off the shelf equipment have been intentionally preferred to more advanced but risky solutions. This policy leads to a

system entering service at the beginning of the next century with built in maturity and with all the consequent advantages, but accepts the risk of being limited at that point in time by technology and equipment existing today.

The platform and system design must therefore face the challenge of being flexible and capable of growing and evolving so that low direct operating cost and high mission effectiveness can be maintained throughout its life. The challenge has been met through the use of selected advanced technologies for the platform and the adoption of a system architecture which allows growth of the basic functions and later expansion of new ones without high modification costs or expensive new training and support equipment.

The NH90 State Of The Art

The multinational requirements of the NATO Frigate Helicopter have identified the following main missions:

- ASW: detection, classification, tracking and attack.
- Anti-Surface Unit Warfare (ASUW): detection, classification, type identification, OTHT.

Normally these missions are mutually exclusive, with the ASW mission being performed with either sonobuoys or ADS, thus requiring a rapid role change capability aboard ship.

The NH90 helicopter is required to meet very strict environmental and physical requirements:-

- Temperature range : -40°C to +50°C.
- Flight operations from ships up to sea state 6, by day and night, in winds up to 45kts from any direction.
- Overall dimensions, blades and tail boom folded, must allow it to be stored in the frigate hangar (4.1 x 13.5 x 3.8m).
- Cabin dimensions : 4m long, 2m wide, 1.58m high.
- Gross take-off weight of naval version less than 9.1 tonnes.

The platform design must provide high survivability by:-

- Low detectability (radar, IR, acoustic).
- Low vulnerability.
- Crashworthiness as per MIL-STD-1290 (85%).
- Safe ditching and floatation capability (2 hours in sea state 3).

Typical NFH flight performance:-

- Normal cruise (ISA) : 240 km/hr.
- Maximum endurance at 140 km/hr : 5hrs 15mins.
- Endurance for ASW mission with sonar, 1 torpedo, 3 crew, at ISA+10°C : 4hrs + 20mins.

In order to meet these demanding requirements, a number of advanced technologies have been selected which offer significant contributions, with an acceptable level of risk.

All Composite Airframe

The results of research activities carried out during last years have pushed industry to select composite material for the airframe of NH90, aiming to reduce the manufacturing costs and weight during the production phase. Use of composites represents an immediate advantage in terms of weight saving (as demonstrated during the research activities) even if such a saving is partially spent compensating for the necessary increase of hardening protection on electronic/electrical installations. Two of the national industries participating at the programme (Eurocopter France (ECF) and Eurocopter Deutschland (ECD)) have already selected this solution on another helicopter presently in development (Eurocopter Tiger), with results encouraging continued use on NH90.

Full Fly-By-Wire (FBW) and Full Authority Digital Engine Control (FADEC)

Long and complex NFH missions are highly stressful for the pilot; missions may have to be performed with 3 crew members only; they can last up to several hours and may include in-flight refuelling; they have to be performed in difficult weather and operational conditions and involve hovering over high seas and landing on a severely moving frigate's deck. The crew's workload must therefore be reduced and the helicopter's handling qualities must be improved for higher hovering accuracy as well as for maintaining the agility required for evasive manoeuvres. Engine shutdown

in flight is also a concern for pilots. The helicopter may be lost if, after an engine failure, sufficient power is not rapidly provided by the remaining engine with the temporary exceedance of the normal mechanical limitations. Manual control of this transition may prove difficult under high stress conditions, and therefore the automatic control of the remaining engine is an important factor to safety. It must be noted that the copilot may also assume the Tactical Operator's role on most missions and the pilot is often left alone to supervise flight safety.

The full FBW System and FADEC provide the technical solution to this demanding requirement while maintaining the necessary level of safety. In the NH-90 the FBW will be "dual fail operational" and will be based on a quadruplex hardware configuration.

Low Radar and Infra-Red (IR) Signatures

The reduction of signatures is an essential requirement for the TTH version, and all measures are fully available to the NFH. The reduction is obtained by shaping of external surfaces, cavities and protrusions to reduce the radar reflection and by using an IR suppressor to reduce the engine exhaust emissions. The characteristic frontal view of the fuselage, with a 10° tilt on the sides has been designed to reduce one of the main contributions to the radar signature.

One-Engine Inoperative (OEI) Performance

During an ADS mission, the dipping phase represents a critical point for the helicopter; while hovering at very low height, the event of loss of power from one engine obliges the crew to perform a fly away manoeuvre to avoid ditching. Such a manoeuvre requires, for a short time (roughly 20-30 secs), a large amount of power from the remaining engine. For NH90, the engine manufacturer has been requested to provide an engine with a very high 30 second emergency rating to maximise the probability of success of this manoeuvre.

Avionic Systems

The Avionic Technology used for the design of the NH90 Mission Equipment Package (MEP) is very advanced, even though it has been intentionally selected giving the priority to risk and cost reduction. In general terms the equipment state of the art is equivalent to the EH101 and in some

cases the same equipment is expected to be used by both helicopters. In the area of the Man Machine Interface (MMI), and of Data Processing, special care has been taken to ensure that no bottle-neck situations will arise when higher performance sensors become available.

A high level of system integration is required, and will be achieved through careful analysis of the functions which must be integrated. Specific attention will be paid to the functions required to interface with the mother ship and with other collaborative units, for the maximum mission effectiveness. This operational interface must happen with high integrity and minimum crew workload, and is of critical importance for the NFH success, because in complex operations the helicopter is expected to collaborate with other aircraft, such as the EH101, which would have the complete picture of the situation and hold the control and command responsibility.

The mission reliability has been given the ambitious target of 97.5% for the 3.5. hours of operation. Careful redundancy management for fail operational capability and optimized installation practices are being used to achieve this target. For the off-the-shelf equipment, a specific Product Improvement Programme (PIP) will be considered, if necessary, to achieve the allocated Mean Time Between Failures (MTBF) figures.

The interaction of the crew with the on board computers is considered critical, and all the facilities available today will be used to obtain an easy, fast and unambiguous interface. It is essential that the crew stations are designed to provide access to the massive amount of data available, either self generated or received via Data link. This data must be presented clearly, when required, to avoid the possibility of operator overload, fatigue or confusion.

The NFH architecture design, shown in Figure 8 is based upon a dual redundant Core Data Bus and a dual redundant Mission Data Bus, defined in compliance with STANAG 3838 (equivalent to Mil-Std-1553B). Additional audio and video distribution networks are provided, plus dedicated links where required for data latency or flight safety purposes. An Armament Data Bus, managed by the dual redundant Store Management Computer's (SMC's) is also foreseen. One of the Aircraft Management Computers (AMC) and one of the Mission Tactical Computers (MTC) control the core data bus and the mission data bus respectively while the other

remains in a 'Hot Stand by Mode'. Two Plant Management Computer's (PMC's) will provide the redundant interface required for the monitoring of non-avionic systems (eg. engines, fuel, hydraulics, electrics, landing gear, transmission, etc.); the PMC's will also implement HUMS and performance prediction functions.

The architecture will support an "all glass cockpit", featuring full colour, NVG compatible Electronic Flight Instrument System (EFIS) and Engine Instrument Crew Alerting System (EICAS), specifically designed to minimise crew workload. This will be essentially achieved through the use of 5 (8"x8" useful area) colour Multi-Function Displays (MFD's) and two Control and Display Units (CDU's). An extensive use of Cursor Control Units (CCU's) as input/selection devices, will also be made, in particular for tactical display management.

5. THE WAY FORWARD

Introduction

From the survey of past maritime helicopter operations, we can attempt to forecast which missions are going to have the major influence on future helicopter design. Despite the great political changes that have occurred in recent years in the Soviet Union and Eastern Bloc countries, there still exists a significant number of unstable areas of the world where conflicts could flare up quickly. Although the overall sophistication and numbers of helicopters involved may be reduced, the diversity of potential threats and operating environments leads to an even greater requirement for operational flexibility and the ability to operate under a wide range of severe conditions.

These political changes have not changed the type of missions required of future maritime helicopters, but have perhaps shifted the emphasis of the driving mission requirements. ASW and ASV are still the prime missions, but with a changed threat, the main requirement has moved from blue water operations to a greater emphasis on coastal or shallow water operations, searching for quieter diesel/electric boats as opposed to nuclear powered submarines. However, if future fleets match current projections, with fleets of 20 strategic submarines for each 'super-power', then each boat then becomes more valuable, but also has a lower probability of

detection. Thus ASW will continue to play a major part in future maritime operations.

Localised conflicts, as indicated by the Gulf War, are likely to involve blockades of harbours and ports, and protection of potential landing areas. The cheapest method is by laying mines, which require very many vessels to counter them. The development of a helicopter mine sweeping capability would be of great benefit in such areas.

Similarly for ASV, where in reduced intensity conflicts it may be necessary to counter small fast missile carrying patrol boats, a target many large anti-ships missiles are unsuited for. Alternatively, as a development of OTHT, further use may be made of UnManned Aircraft (UMA's) using small, "cheap" aircraft as remote sensor platforms for the ships' long range offensive and defensive weapon systems. Shipborne UMA's were used to great effect during the Desert Storm operation.

Following the successful introduction of AEW helicopters into UK and Spanish service, this role is likely to expand as ageing carrier based fixed wing AEW aircraft require replacements. At the same time, the cost of maintaining a larger carrier based naval air force is becoming prohibitive, and so the combination of Vertical and Short Take-Off and Landing (VSTOL) aircraft and helicopters could become attractive, particularly if the helicopters can provide all the AEW and Electronic Warfare support provided by conventional fixed wing assets.

Finally, the off shore exploitation of ever dwindling oil reserves will require the continued support of a more sophisticated helicopter fleet. The reduction in oil reserves will lead to platforms moving further off-shore, and the pooling of helicopter resources amongst operators. In this way, the operating costs of larger and more capable all weather helicopters can be spread.

The following sections describe some of the key technical challenges which the designers of future maritime helicopters have to face, if they are to fulfil their potential in an ever changing world.

Crew Comfort and Workload

It is interesting that the general issue of crew comfort may be considered on top of this future challenges list. In fact crew comfort, which equates to noise and vibration reduction, temperature control, simplified man machine interface, cockpit

visibility etc, has been typically compromised any time it collided with other requirements often considered more important, such as weight, cost and multi-mission capability.

Today we see more and more indications that this attribute is moving up the scale of priorities because the advances in the other capabilities have created such a very demanding task for the crew, that their performance is becoming a limiting factor to the full usage and exploitation of the helicopter capability. Therefore the physical and mental operating environment for the crew must become less tiring so that the endurance of the helicopter can be increased further and provide maximum mission effectiveness.

Special care will have to be paid to the pilot-computer interaction. Steps forward are still required to provide simplified, friendly and non ambiguous access to data and controls. The computers monitoring role on the aircraft must gain the pilot's full confidence and provide safety by immediate warnings and corrective action, as well as with keeping track of any slowly degrading situation.

In addition, the crew must be provided with a clear unobstructed view of the outside world. This is vital for operations in restricted areas and onto small and moving platforms.

The technologies for these improvements seems to be available, but up to now the associated cost and weight tag that has precluded the incorporation of these improvements into the naval helicopter.

Cabin Comfort

Cabin comfort is an important factor in the acceptance of the helicopter in both the civil and military fields. In the civil market place, the cabin environment is the main parameter governing passenger acceptance, and in the military sector, it has a major influence on crew fatigue, and hence endurance. The key factors affecting the cabin environment are noise, vibration and air conditioning. The latter point should be a simple matter of designing a suitable conditioning system and making appropriate allowances in the installed power of the helicopter. The first two, however, are a fundamental result of the design of the aircraft, and require careful initial design and the application of active vibration reduction systems. The adoption

of active vibration reduction system should be most efficient, as it results in a lighter structure.

Speed

An increase in the cruise speed of helicopters can contribute significantly to the operational capability in many ways. In an ASW patrol mission, increased speed provides a reduced time to arrive on station, particularly if operating at long range ahead of the fleet (a greater requirement as the threat becomes quieter), and also allows a greater area to be covered in the same time. Other missions, such as SAR, require a rapid reaction time, where the helicopter dash speed can be essential to saving life.

In civil operations, increased speed can provide a greater sortie rate, allowing more passengers to be transported with fewer aircraft and improving aircraft productivity. However, it is generally considered that any further increases in helicopter performance may be to the detriment of other important factors, such as cost, endurance, hover performance or size. Thus the challenge is to improve the helicopter speed whilst not penalising helicopter performance, which may be achieved through, for example, compounding, engine developments and aerodynamic improvements of the rotor blades, hub and fuselage. Once a basic "clean" design has been achieved, then this must be maintained through all operational configurations. It should be noted that this philosophy is also required to minimise the signatures of the aircraft, any external additions, such as antennas, weapons, increase both Drag and Radar Cross Section (RCS).

Endurance

At present, typical ASW helicopter missions have an endurance of up to 4 hours or more, compared to 8 to 12 hours for shore based fixed wing patrol missions. However, to cover the same area as a fixed wing aircraft by helicopter, would require much longer endurance due to its lower speed. To achieve a significant increase in endurance requires more than just more fuel, since the crew endurance is just as critical, as is the reliability of the equipment, and the ability to persist with a tracking or engagement opportunity. Compromising all of these requirements is the necessity to keep the helicopter small, to fit the ship, and to maintain a small crew. Thus to enable improvements in endurance, requires improvements in other factors already described, such as crew/passenger workload

and comfort (so that the crew is capable of carrying out the mission effectively and more importantly, to recover the aircraft under difficult conditions), reliability (of both the airframe and equipment) and an enhanced detection and attack capability (such that multiple targets can be engaged over a long mission). Other solutions can be adopted as an alternative to increased fuel capacity, such as improved fuel economy, which would also provide a cost saving, or air-to-air refuelling, either from fixed wing or as "buddy-buddy" refuelling from helicopter tankers. As examples CH-53 and EH101 type aircraft could be converted to suitable tanker configurations.

All Weather Operations

All weather operations is one of the most critical aspects of helicopter design, influencing its configuration, rotor design, flight controls, man machine interface, avionic systems and deck handling systems. The crew fatigue, workload and man machine interface, requirements have already been discussed, but the aircraft handling and ship/deck interface need further attention.

Full all weather operations will require a comprehensive sensor suite to provide the pilot with sufficient information to prevent disorientation and provide inputs to the flight control system to allow him to land the helicopter accurately and safely. The flight control system must provide low work load (to prevent fatigue) and good carefree handling qualities so as to allow precision manoeuvring over a small platform (and for winching in SAR operations). The mechanical design of the rotor system must then be designed to provide sufficient control power for control of the aircraft and to counter gust inputs.

The helicopter ship integration is a vital factor, not only of all weather operations, but also ensuring maximum overall mission effectiveness. In respect to all weather operations, the design of the ship can put very demanding constraints upon the design of the helicopter. The size and location of the landing platform will determine the local aerodynamics (particularly turbulence) and the actual rotor disc size allowable. (Similarly, the size of the hanger determines overall helicopter dimensions, folding requirements, spares holding, special support equipment and the local airflow around the deck). However, it is the landing phase, (approach, touchdown and securing to the deck) that are most critical in severe weather, requiring a stable

platform, energy absorbing undercarriage and a secure locking mechanism to ensure safety of both the helicopter and ship. Current systems utilise either a decklock or hauldown approach, but the next step may be to remove the man from the loop, and then develop the system for application to unmanned aircraft.

Crew Proficiency

An important component of the crew proficiency is its level of training. It is expected that in addition to the present use of ground based flight and mission simulators, in flight mission training can be enhanced with the use of "flying simulators" capable of injecting additional simulated inputs into real operational situations, such as sonics, radar, ESM etc, in order to familiarize the crew with the necessity to cope simultaneously with the current situation and with a more demanding unexpected development.

To support this training and build up a data base of tactical intelligence, extensive use of data and voice recorders will be necessary together with the adequate ground facilities for post processing and aggregation of the recorded data.

In general terms it is expected that in-flight crew aids will be improved. Automatic check list, flight manual data, navigation and communication information, sea bed contours, bulk water motion, coastal mapping, digital mapping, are likely examples of welcome aids for the crew in the near future.

Sensors

Modern helicopters already carry a large range of sophisticated sensors in order to detect, track and attack targets, for self protection and for navigation. However, at present, sensors for night/adverse weather capability are generally limited to NVG's. Some special operations and SAR aircraft are fitted with FLIR or terrain following radar, but many improvements could be made by adopting sensors from their battlefield counterparts, which tend to be better equipped. However, it may be necessary to develop sensors which are optimised for the maritime environment (salt, sea spray, mist, etc) to improve performance and reliability. But at the same time, cost and mass must be reduced to allow such sensors to be installed on smaller helicopters and be adopted for civilian use.

For attack sensors, Radar and FLIR will remain the primary system for surface search, but with developments improving detection range and recognition against smaller and more uncooperative targets. This also applies to sensors for underwater targets, which in future will be smaller and quieter. As before, other driving parameters are going to be cost, size and mass, such that new sensors can be deployed aboard smaller helicopters. In addition, the mode of operation of the sensors will have a severe impact upon mission endurance (eg number of disposable sensors, or time spent dipping) and so alternative sensors should provide improved "persistence" or allow greater vehicle efficiency.

Attack Capability

The two primary offensive missions for the maritime helicopter remain ASW and ASV, although there is a potential "ground attack" and "air-to-air" requirement for assault operations.

For ASW, the primary weapons will continue to be depth charges and torpedoes. Depth charges are limited by their kill radius and the lack of any homing capability to close-in onto the target. Torpedoes are still limited in size and weight for carriage aboard helicopters, which in turn limits warhead size and motor endurance. However, limitations in warhead size can be overcome by improvements in warhead technology (greater effectiveness) and guidance capability (getting closer to the most vulnerable part of the target).

For anti-ship operations, there are two potential scenarios, attack of large surface units and warships, and countering small patrol boats. In the first instance, warships (from corvettes upwards) have increasingly capable air defence systems. This then requires two developments to enable to helicopter to safely engage the target, firstly reduction of signatures to penetrate the ship defences, and secondly increased stand-off range of the weapon. The latter has the drawback that longer range, requires a larger missile, which in turn requires a larger helicopter and increases the problems of clean carriage (both aerodynamically and signature wise). Secondly, the attack of fast patrol boats presents different problems due to the small size of the target, requiring a sophisticated sensor/missile combination to engage at a range beyond the defence capability of the target, which although may not have long range radar guided missiles, will have IR guided missiles and radar directed guns.

In the future, weapons may be developments of anti-ship missiles for fixed wing aircraft, or anti-armour weapons adopted for the maritime environment.

Survivability

An important improvement area can be defined around the requirement for stealth characteristics and self protection. The reduction of Radar and IR signatures has not been considered a high priority attribute for naval helicopters as it has for typical army vehicles. The reason was that out on the seas, with no masking opportunities it was considered virtually impossible to avoid detection from long range ship radars and therefore the only sensible thing to do was to provide a warning to the pilot so that the threat could be taken into consideration and avoided before the helicopter could be detected.

This is still true but a new scenario is becoming more frequent for the long range patrol mission, escort or amphibious assault, in which the helicopter opponent is typically a small fast boat or a light aircraft with unsophisticated radar and armed with short range IR missiles. In this case the capability of detecting before being detected becomes very important for survival and implies a reduction of Radar and IR signatures to the levels achieved for the Army Helicopters. Finally, if detection cannot be avoided, then self protection will have to be provided.

It appears almost impossible to provide an efficient self protection against any possible threat, but something may be done to develop specialized self protection kits which could be installed quickly in response to an expected threat; air to air missiles, machine guns, advanced rockets and armour, can provide the basic vehicle with low vulnerability and high survivability features.

A concluding remark on the issue of detectability and self protection is that the increasing priority of these attributes is a direct consequence of the increased effectiveness of the modern naval helicopters which have become a severe threat and therefore a rewarding target for opposing ships and aircraft.

Safety

A common public misconception is that the safety of the helicopter is insufficient, even though they are expected to operate under the most hazardous

conditions to complete SAR missions. Thus it is necessary not only to technically match the safety record of fixed wing aircraft, but to exceed it and be seen to be a safe alternative to both light aircraft and surface transport. This increase in safety would also pay dividends in areas where there is no choice but to use the helicopter, since increased safety would have a direct relationship to cost - failures and accidents are expensive, both in monetary and human terms. The most obvious route for safety is through reduced complexity, detailed attention to design and robust manufacture.

Thus safety must be taken into account with good safety factors, redundant design (both for mechanical and electrical systems) and good equipment levels, and yet achieve this within an efficient and cost effective design. One benefit of large margins of safety is growth potential for future versions, and the ability to survive unforeseen circumstances.

Reliability and Maintainability

Reliability and Maintainability (R&M) is a major contributor to aircraft life cycle costs, direct operating cost and safety, and is closely related to the improvement in capability, in terms of endurance and all weather operations, and impacts the shipborne support requirements. Thus improvements in R&M have many beneficial secondary effects in other areas.

To achieve these improvements demands that R&M be a design consideration from the earliest stages, in the layout of the aircraft, design of components, avionics architectures and installation, and the design of Built In Test Equipment (BITE). Equipment and component installation and access must be given due consideration to provide for simple replacement.

In the avionics systems, the adoption of a common module approach would give a reconfiguration capability to overcome individual failures, thus ensuring mission reliability, and at the same time reducing requirements on spares holding and dedicated test equipment. This approach could be extended such that common modules are used both in the aircraft and the ship systems, providing benefits of economy of scale and improved supportability.

Associated with the implementation of a modular avionic package, with automatic reconfiguration, is

Built In Test (BIT) capability of detecting all faults quickly and accurately. However, even without modular avionics, a comprehensive and reliable BIT would be of great benefit in improving maintainability.

Improving R&M would allow a reduction in spares holdings and dedicated support equipment aboard ship and in this way can have secondary benefits in allowing a reduction in the ship and/or hanger sizes and in support crew.

Operational Availability

An important opportunity for improvement may be proposed in the area of mission availability. Specifically, before take off and during the flight, a complete parallel test of all the subsystems needs to be periodically carried out, with a high level of fault detection probability in all the available functions, both active and quiescent. The system must provide confidence that all systems are really ready to go and are capable of providing the expected performances.

In addition, in the event of a detected failure, the status of all related software steps should be read and recorded for later processing by a diagnostic tool. Hopefully even prognosis could be provided, so that the real effect of the limitation of performance can be estimated in advance and displayed to the crew. At present, this feature is currently available on military GPS receivers and other navigation sensor which are capable of estimating their own errors and instructing the higher system to initiate the degraded mode of operation.

It must be considered that such levels of autodiagnosics are probably a condition for taking on brand new additional functions because otherwise the saturation of the human skills necessary to operate and maintain these advanced systems may well lead to a sharp fall in effectiveness of the total helicopter.

Cost Effectiveness

The bottom line for both military and civil operators is cost effectiveness, both initial purchase and operating costs. All operators are seriously concerned about initial purchase price, support costs, crew costs and fuel costs. In addition the military user is concerned with development costs, which in current circumstances may have to be

amortised over a very short production run, thus requiring savings to be shown during operation.

All of these requirements need the development of improved R&M, safety, performance and capability, but without an associated increase in development or procurement cost. Improvements to the vehicle must be justified in reduced operating cost, either through reduced support requirements (spares and manpower) or improved productivity (more flying hours). When considering such costs, the helicopter should not be considered in isolation, it being the complete transportation system or helicopter/ship/weapon system that should be costed. However, there are some factors that are difficult to cost such as flexibility and excess capability/growth potential.

6. CONCLUSIONS

A number of important conclusions may be drawn from this survey.

1. Over a period of 50 years the helicopter has strongly established itself in maritime roles.

2. Today, some 2000+ helicopters operate in seven primary areas of application in:

- Anti-Submarine Warfare
- Anti-Surface Operations
- Airborne Early Warning
- Search and Rescue
- Law Enforcement
- Amphibious Assault
- Off Shore Civil Operations

3. Two major new European Helicopters - EH101 and the NH90 NFH - represent the state of the art in helicopter technology and provide the industry with unique opportunities to secure a pre-eminent position in the world maritime helicopter market.

4. The future is increasingly unpredictable, and in an environment of reducing defence budgets the industry is faced with the conflicting pressures of the requirement for an increasing capability, at a lower cost (of purchase and operation).

5. The requirement to reduce cost will drive down the size of the parent ship imposing design constraints on the size and flexibility of the helicopter vehicle whilst still demanding increasing capability.

6. The industry must collectively respond to the enormous challenge of sustaining and increasing the application of the helicopter in the maritime market.

7. To sustain the development of the market a wide range of helicopter technologies must be developed - there are no single or simple panaceas!

8. Of the wide range of technical challenges highlighted by this survey, particular importance is attached to the following:-

- i) Increasing operational availability and flexibility.
- ii) Improving cost effectiveness.
- iii) Improving crew and cabin comfort and reducing workload.
- iv) Improving reliability and maintainability.
- v) Improving safety.
- vi) Improving sensors.
- vii) All Weather Operations.
- viii) Increasing endurance.

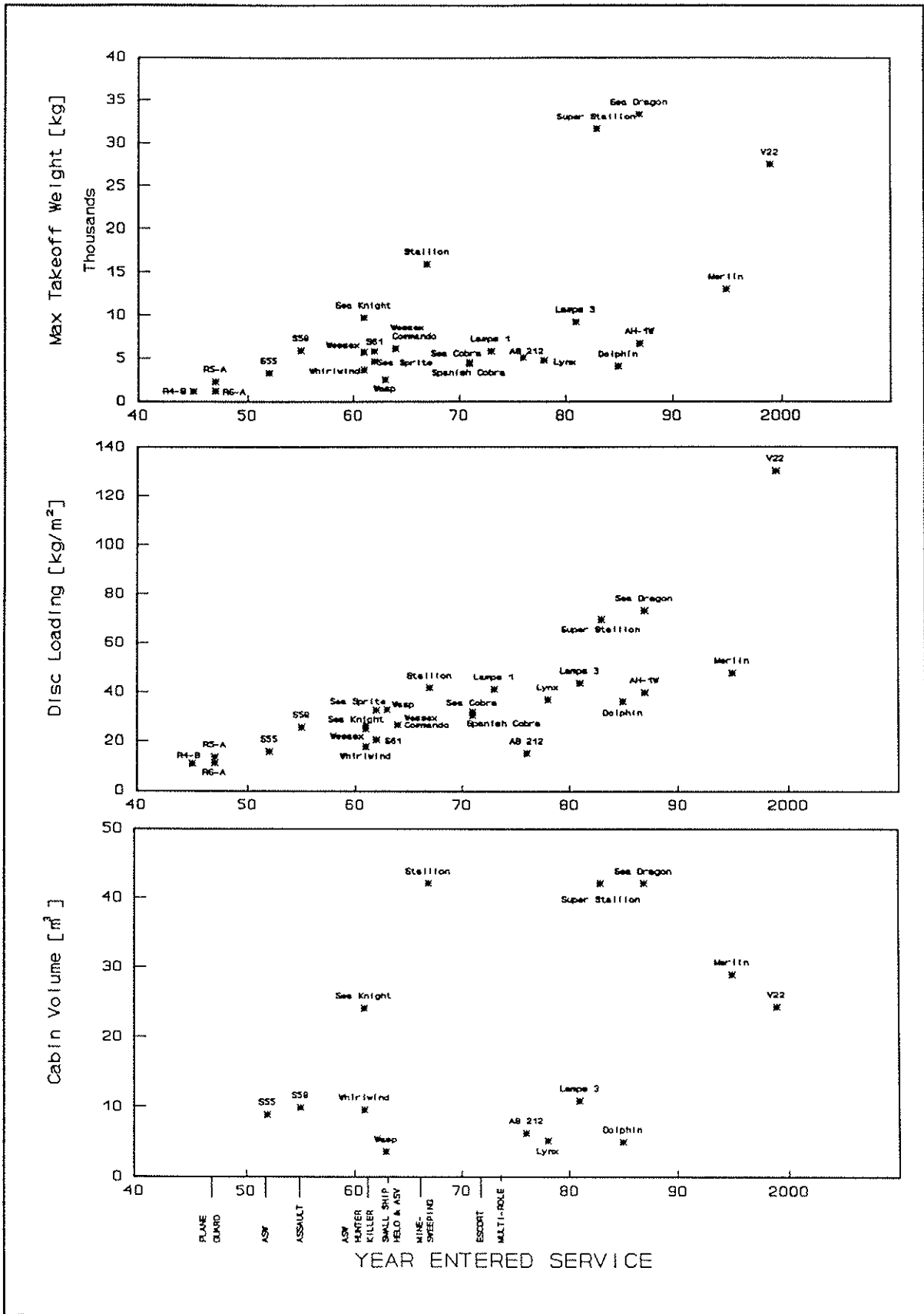

Figure 1 : TECHNICAL DEVELOPMENT OF HELICOPTER TECHNOLOGY, PART 1

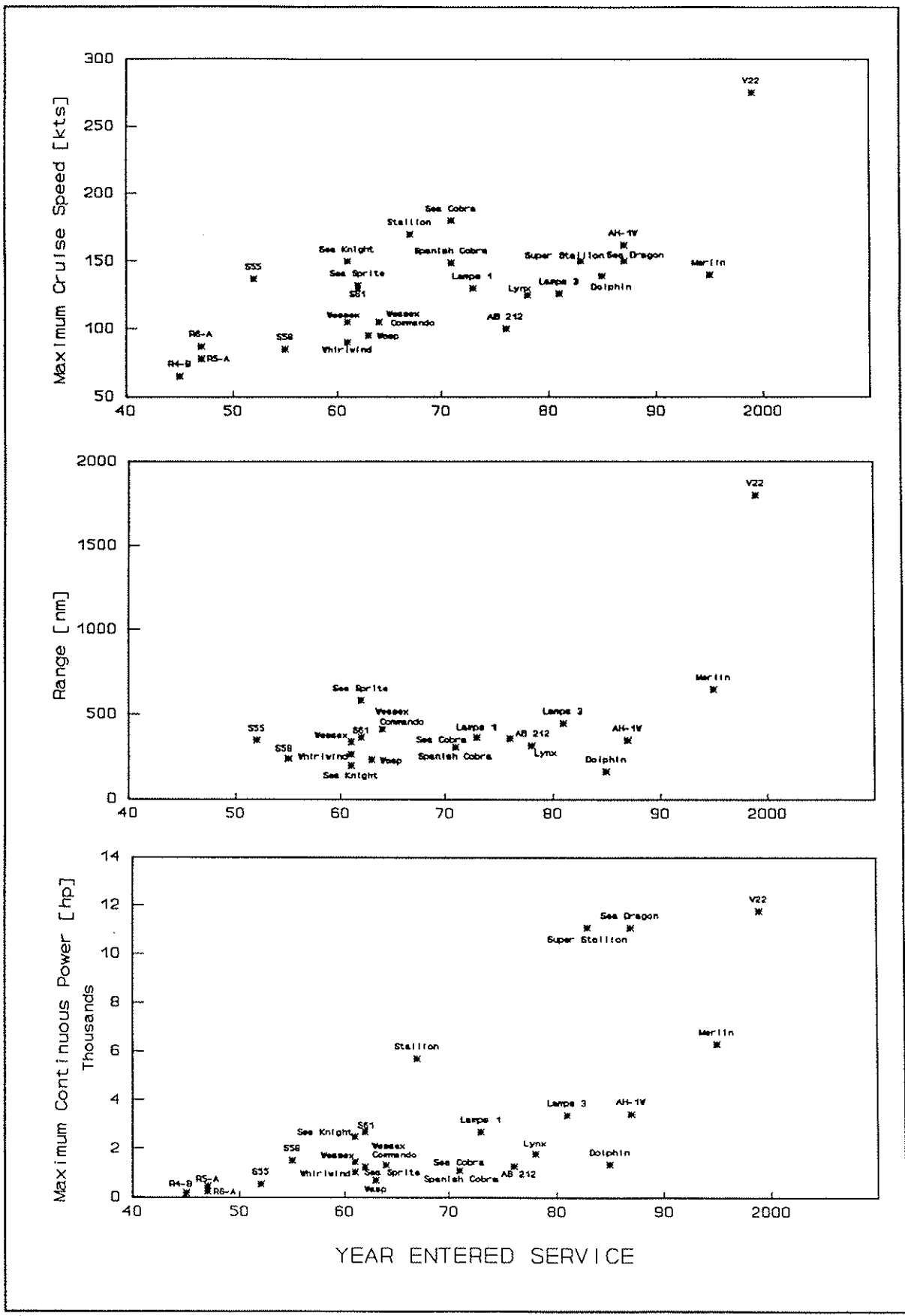

Figure 2 : TECHNICAL DEVELOPMENT OF HELICOPTER TECHNOLOGY, PART 2

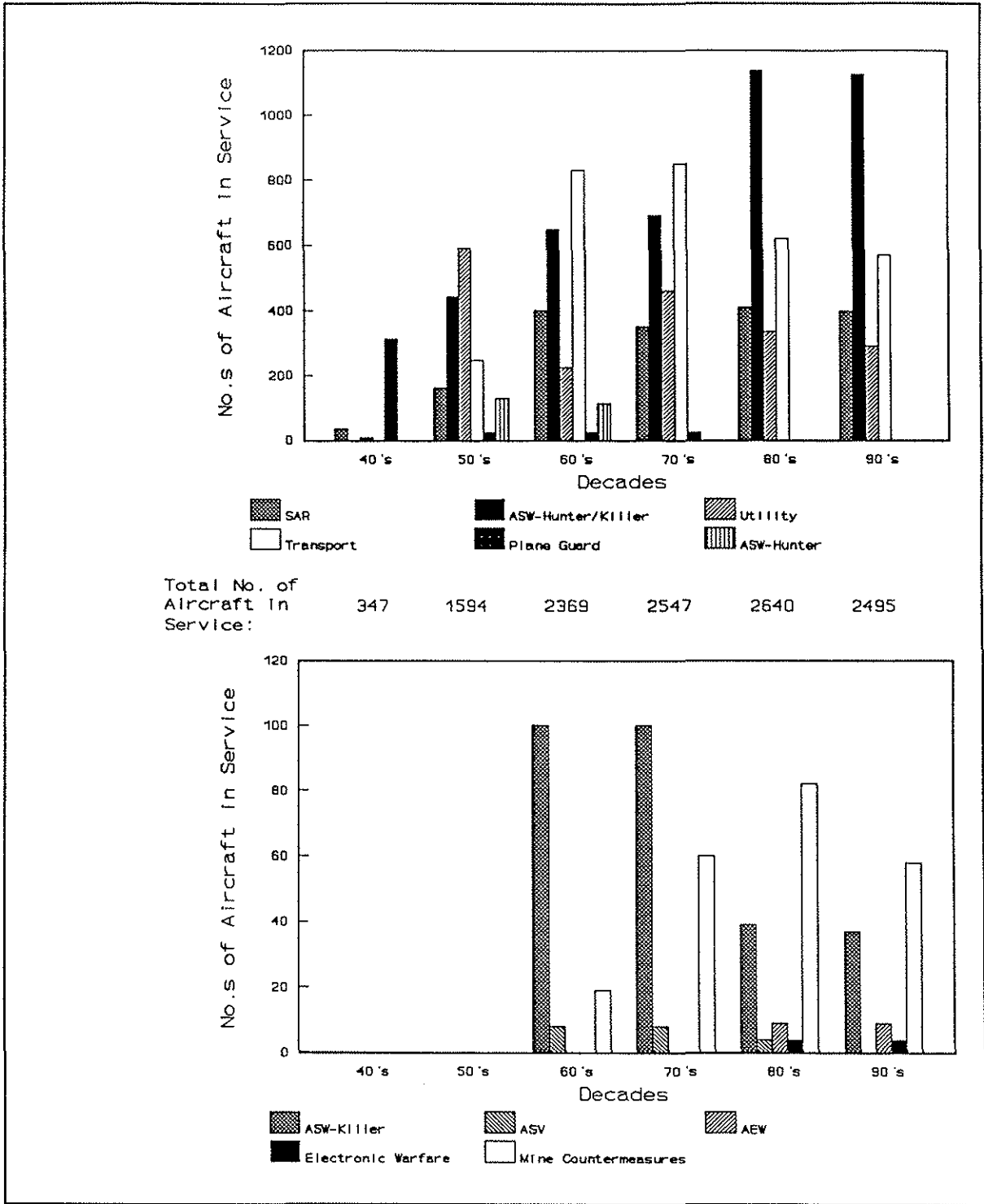

Figure 3 : CHANGE IN AIRCRAFT NUMBERS THROUGH THE DECADES



EH101 - Typical ASW Layout

E5884-04

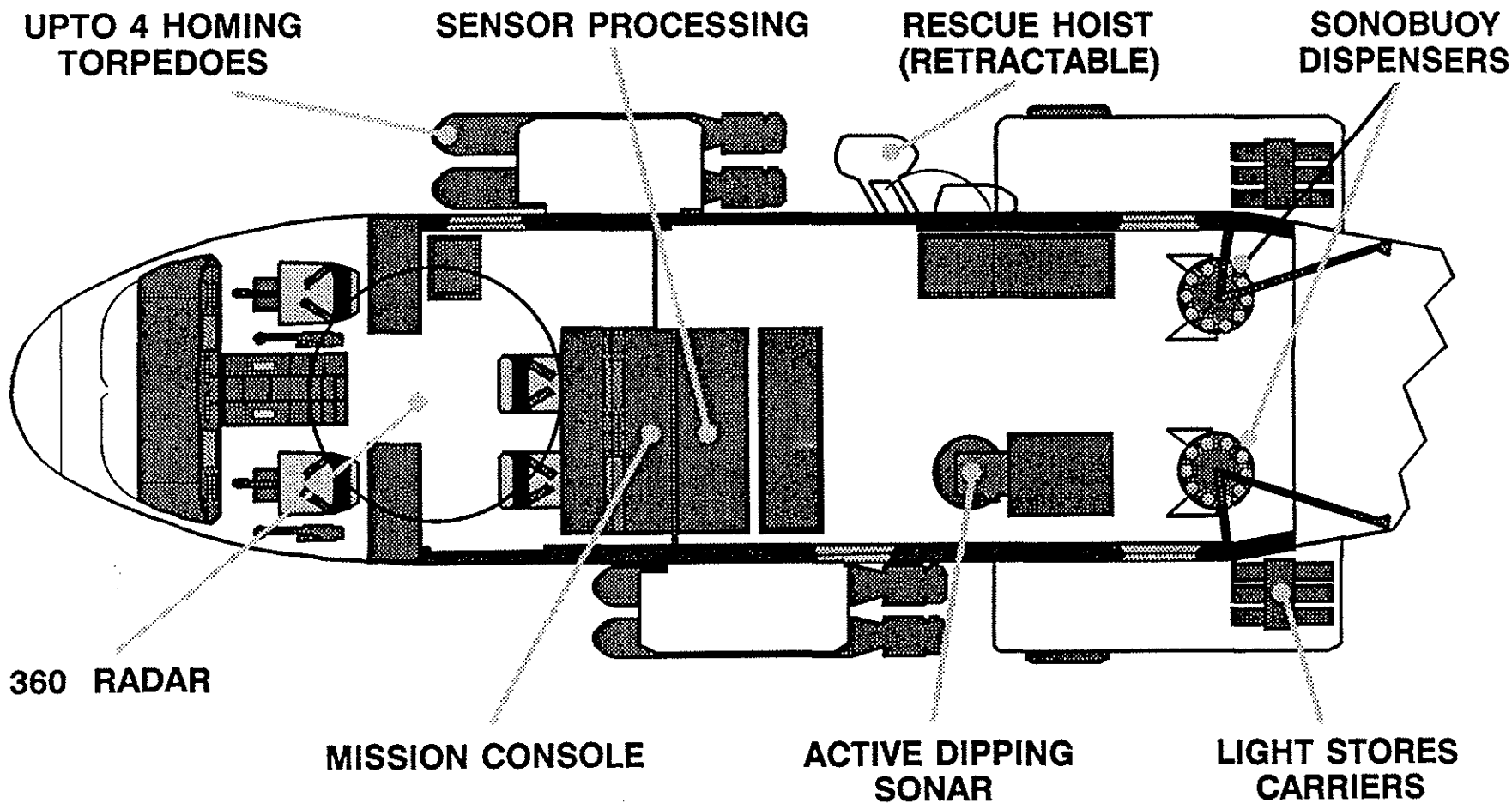

Figure 4 : EH101 - TYPICAL ASW LAYOUT
504 - 20



ACSR Actuator Installation for EH101

E5799-14

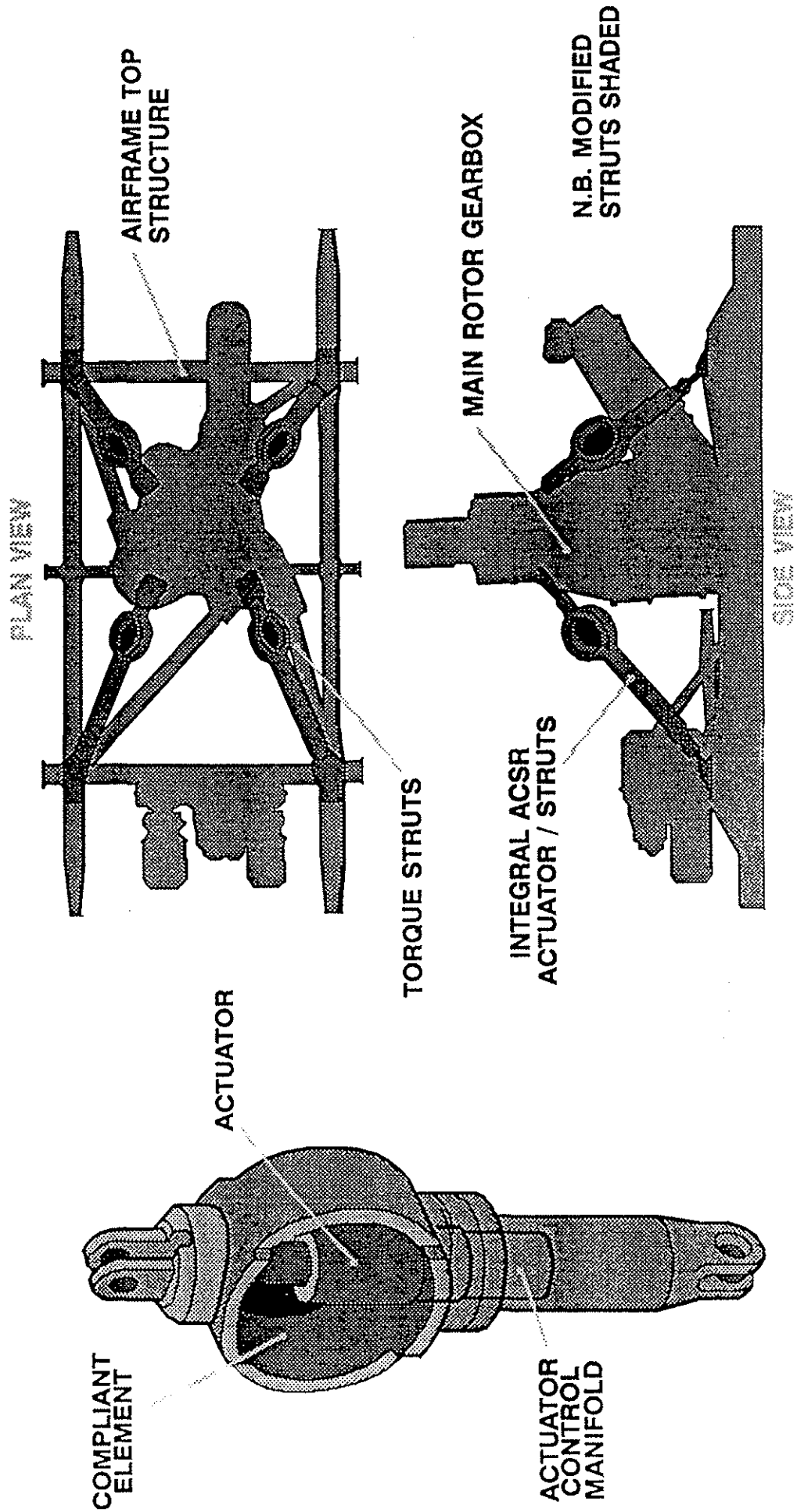

Figure 5 : ACSR DEVELOPMENT ACTUATOR INSTALLATION ON EH101



EH101 Simplified Avionic Architecture

J6619-24

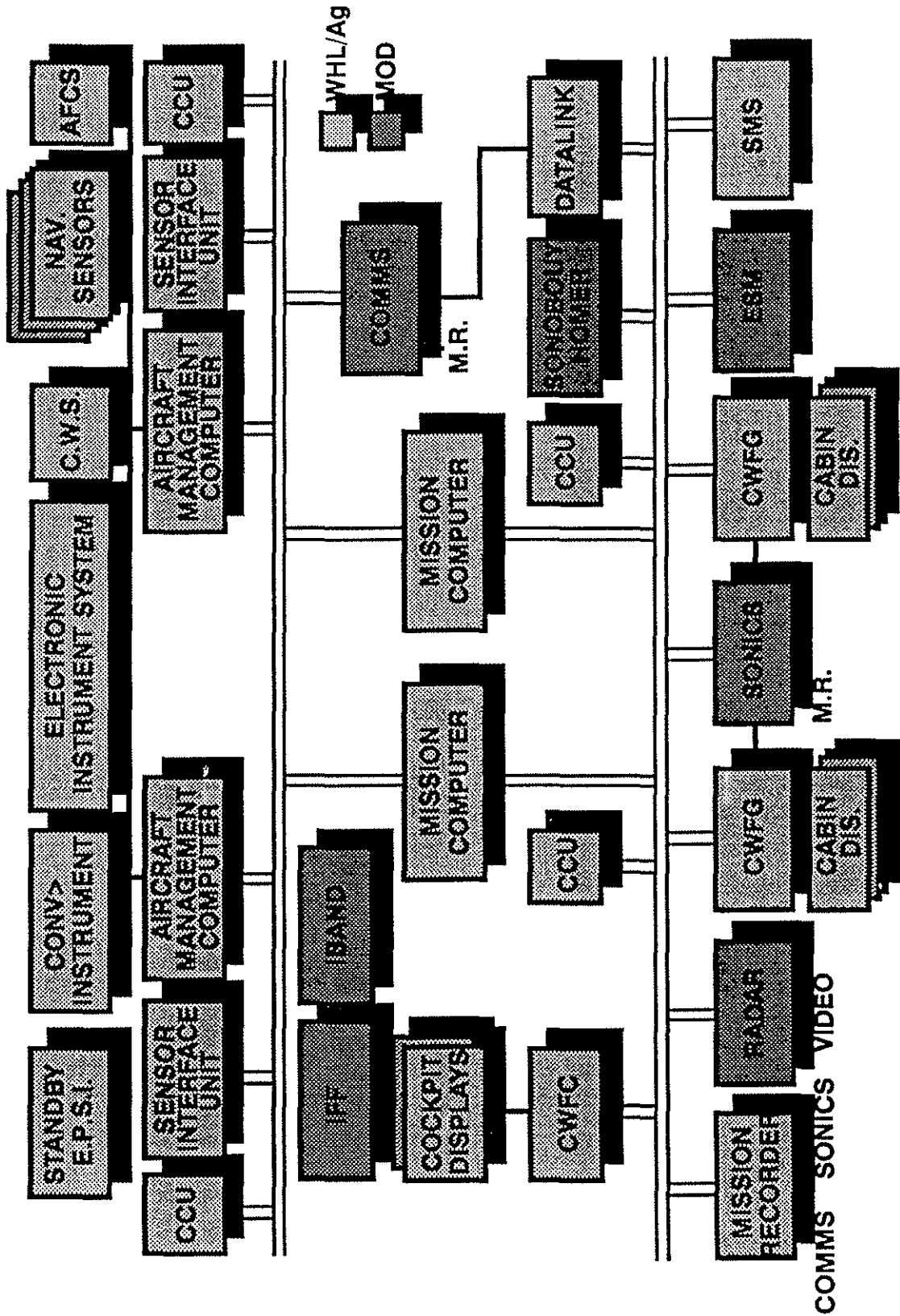

Figure 6 : EH101 SIMPLIFIED AVIONIC ARCHITECTURE

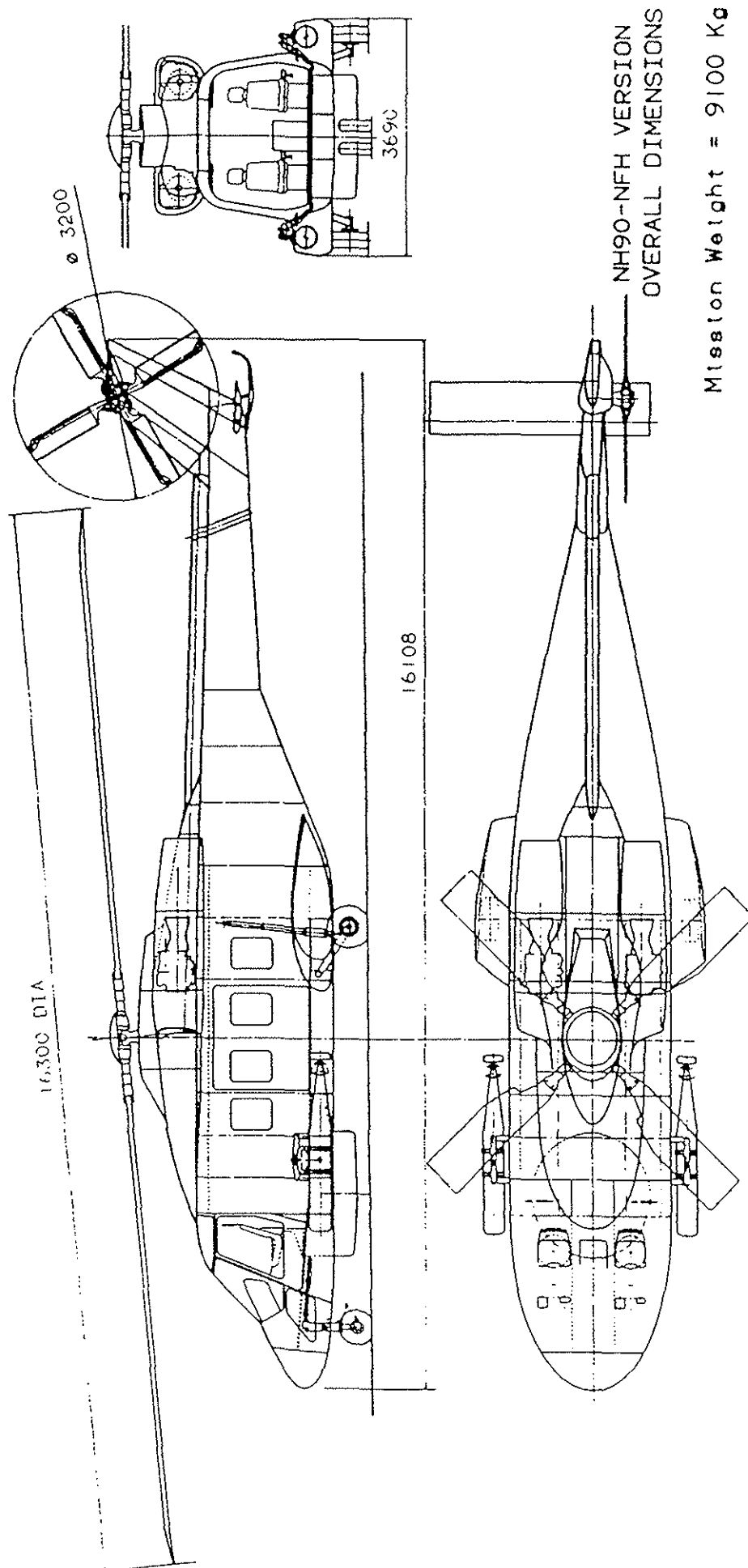

Figure 7 : NH90 - NFH GENERAL ARRANGEMENT

Figure 8 : NH90 - NFH AVIONIC ARCHITECTURE
504 - 24

