

# AN INVESTIGATION INTO THE USE OF SIDE-ARM CONTROL FOR CIVIL ROTORCRAFT APPLICATIONS

S. Baillie and S. Kereliuk  
National Research Council of Canada  
Ottawa, Canada

## Abstract

An evaluation of the handling qualities of civil rotorcraft incorporating force or displacement sensing side-arm controllers with varying levels of control integration was carried out on the NAE Bell 205 Airborne Simulator. Evaluators were certification pilots from the FAA and Transport Canada. The results indicate that integrated 4-axis side-arm control is a viable option for civil rotorcraft operations, even when used in conjunction with very low levels of stability and control augmentation.

## Introduction

The advent of fly-by-wire technology and its adaptability to integrated multi-axis side-arm control will have far-reaching effects on the design and operational utility of rotorcraft. Some of these effects are highly visible such as on physical constraints in cockpit design, pilot view and comfort and crashworthiness. Other effects, such as those on the handling qualities, in terms of pilot workload and performance, can only be defined by acquiring in-flight data.

Background The application of multi-axis side-arm control for rotorcraft operations has been investigated by the Flight Research Laboratory (FRL) of the National Aeronautical Establishment (NAE) since 1979 (Ref. 1 to 5). These past activities have been aimed primarily at military rotorcraft operations addressing, in large part, military rotorcraft handling qualities specifications. Although certain phases of military operations resemble civil use of rotorcraft, requirement specifications and certification procedures differ.

The Flight Research Laboratory has been performing research on civil helicopter handling qualities in cooperation with the U.S. Federal Aviation Administration (FAA) under MOA AIA-CA-31. This report deals with one of the latest experiments performed under this agreement.

Scope of the Program This experiment was designed to address the following issues:

- a) Is multi-axis integrated side-arm control a viable option for civil rotorcraft operations?
- b) How is pilot workload and performance affected by the use of this mode of control versus the use of conventional controls while performing tasks representative of civil operations.
- c) Are there any special civil certification issues which must be addressed for deflection-sensing and force-sensing integrated side-arm controls?

## NAE Airborne Simulator

Experiments were carried out using the NAE Airborne Simulator, an extensively modified Bell 205A-1 with special fly-by-wire capabilities that have evolved over the last seventeen years (Figure 1). The standard hydraulically boosted mechanical control actuators incorporate servo-valves that can be positioned either mechanically from the left (safety pilot) seat or electrically from the right (evaluation pilot) seat full authority fly-by-wire station. Fly-by-wire inputs are generated by a set of motion sensors and a computing system consisting of two LSI 11/73 and one Falcon microprocessor and D/A and A/D converters. Inputs to this system come from electrical controllers which may be either a conventional stick, pedals and collective combination with a programmable force-feel system or, alternatively, a 4-axis isometric force or deflection side-arm controllers or any viable combination of these systems.

Other modifications to the NAE Airborne Simulator have been made to increase the *simulation envelope* of the facility. To quicken the control response of the teetering rotor system, the standard Bell 205 stabilizer bar was removed; and to provide an additional pitch axis control, the longitudinal cyclic-to-elevator link was replaced with an electro-hydraulic actuator, although, for this program, the elevator remained fixed in the neutral position. Reference 6 provides a full description of the NAE Airborne Simulator.

Aircraft Configuration The use of a side-arm controller in a rotorcraft implies that some level of *fly-by-wire* technology is present in the aircraft, if only to allow the electrical signals of the controller to be passed to the control system. On the other hand, any rotorcraft with a side-arm controller could also be highly

advanced to the point of almost totally automated flight. While both extremes raise interesting research and certification issues, it was decided early in the experiment development process that the rotorcraft dynamics to be used in the evaluation should be representative of the most probable configuration which would first appear on the civil market.

Although it is not the only successful civil rotorcraft on the market, the Sikorsky S-76 is representative of most rotorcraft currently in production and clearly is a standard in terms of stability augmentation and IFR capability. With this in mind, the decision was made to configure the NAE Bell 205 Airborne Simulator to possess dynamic characteristics which were similar to the S-76 with stability augmentation system (SAS) engaged. Unlike the standard S-76 SAS, which decreases with speed and reverts to a constant level of damping at speeds below 40 knots, the airborne simulator rate damping matched the S-76 levels at high speeds but continued in a linear reduction all the way to hover. Interaxis control coupling between all axes were reduced to a very low level by the use of simple control cross feeds to the respective control axes. This characteristics is also similar to a fully augmented S-76. The hover rate damping derivatives of the Airborne Simulator, as used in this experiment, were 3.0 and 4.2 sec<sup>-1</sup> for roll and pitch axes respectively. Bode plots of the aircraft control response in terms of attitude per unit of control input are included as Figures 2 and 3. These units of control input are directly related to the controller sensitivity values given in Table 1. The implementation of control filtering and integral trim on each of the controllers is documented in Figure 4 while Figure 5 shows the pitch and roll control system architecture.

The yaw axis of the Bell 205 was configured as a rate command / heading hold system which blended to a sideslip command / turn coordination system at 35 knots (Figure 6). The vertical axis was a standard collective system with the sensitivity and heave damping of a standard Bell 205.

Controllers For this experiment, two side-arm control configurations were flown and compared with conventional controls comprising a cyclic stick, tail rotor pedals and collective lever.

The side-arm control configurations were:

- a) a 4-axis force controller with compliance in pitch and roll axes (Figure 7)
- b) a 4-axis deflection controller (Figure 8).

Table 1 summarizes the characteristics of the three control configurations. **It must be noted that the 4-axis displacement controller evaluated in this experiment possessed physical breakout/gradient characteristics which were not optimized.** The same controller was evaluated in a prior experiment (Ref. 3) with nearly optimum characteristics which are also described in Table 1. In addition to the three major systems, various *integration levels* of side-arm control were also examined for each side-arm controller. These integration levels, as shown in Figure 9, were 4 + 0 (fully integrated), 3 + 1c (collective separate), 3 + 1p (pedals separate) and 2 + 1 + 1 (fully distributed).

### Experimental Procedure

Evaluation pilots typically assessed either one or two controller configurations on a given flight. To ensure that each evaluator was consistent in his performance of the evaluation tasks, the safety pilot demonstrated all tasks using the conventional controls at his station on the first flight. From that point on, evaluators assigned handling qualities ratings (HQRs) using the Cooper-Harper handling qualities rating scale (Ref. 7), and filled out a questionnaire (Figure 10) for each control configuration as it was encountered. Post flight debriefings gave the project engineers the opportunity to clarify the written comments of the pilot and to discuss, in more depth, the pilot's reasoning behind his assessments. Table 2 gives the sequence of evaluations for each evaluator. This order was designed to determine whether the sequence of evaluations (force or displacement first) would alter pilot assessments.

A total of 47.1 flight hours were flown by four evaluators (12 hours each). On completion of all evaluations, each evaluator filled out a general questionnaire (Figure 11).

Tasks The evaluators were required to perform the tasks shown pictorially in Figure 12 two or three times for each configuration and to provide evaluations for the following tasks:

Precision Hover The evaluator was asked to maintain a precision hover with respect to a traffic cone viewed through side window markings (longitudinal and lateral position approximately  $\pm 3$  feet). Height was to be maintained at  $5 \pm 2$  feet and heading to  $\pm 5$  degrees of nominal.

Precision Landing A landing was performed with the view of the traffic cone maintained in the side window markings (position accuracy approximately  $\pm 1.5$  feet). Vertical descent rate

was required to be continuous to touchdown with no perceptible longitudinal or lateral drift.

Sidestep A sideward hover-taxi manoeuvre was required across a circle of 200 feet in diameter. Height was to be maintained at  $10 \pm 3$  feet, heading at  $\pm 10$  degrees from nominal, and the manoeuvre was to be completed in 15 seconds or less.

Hover with Divided Attention The evaluator was required to change radio frequency while maintaining a hover position of  $\pm 10$  feet horizontally and a height between 2 feet and 15 feet above ground.

Pirouette The aircraft was manoeuvred around a marked circle of 200 feet in diameter with the nose pointed towards the centre of the circle at all times. Tracking tolerances were  $\pm 10$  feet from the circle circumference with height maintained at  $10 \text{ feet} \pm 5 \text{ feet}$  and heading was to be controlled within  $\pm 10$  degrees of the circle center-point. Lateral velocity was to be controlled smoothly, allowing completion of one circuit in a maximum of 45 seconds.

Figure Eight The evaluator was asked to track, in forward flight, a marked figure eight pattern composed of two, 200 foot diameter circles. Height was to be maintained at  $10 \pm 5$  feet, allowable lateral tracking tolerances were  $\pm 10$  feet from the marked track and the manoeuvre was to be completed in less than 50 seconds.

Quick Stop From a hover position, the aircraft was accelerated to 35 knots groundspeed and then rapidly decelerated to a stop in a total distance of approximately 600 feet as referenced by ground markers. Heading was to be maintained at  $\pm 10$  degrees and the maximum allowable height was 25 feet.

Slope Landing A landing on a four-degree slope was performed with aircraft heading perpendicular to the slope. The manoeuvre was to be performed with precise control of the downslope skid and with no perceptible drift on touchdown.

Obstacle Clearance Takeoff and Steep Approach From a hover, with maximum engine power, an obstacle clearance takeoff was performed into a tight circuit with a steep approach to a hover.

Entry into Autorotation While in cruise, with the evaluator pilot in control, the safety pilot reduced the throttle to idle to simulate a rapid engine failure. The evaluator then selected a suitable field for landing and performed left and right 90 degree turns while controlling airspeed and rotor speed to within the Bell 205 specified limits. Because throttle control was

not available to the evaluator, the safety pilot took control for the recovery. Laboratory policy does not allow practice in full-on autorotation landings in the airborne simulator.

Instrument Approach The evaluators were provided with a precision tracking task in the form of azimuth, elevation and airspeed information representing an MLS approach at a 6 degree elevation angle. A flight director display was used to track the localizer and the glideslope at 60 knots, and then decelerate on a profile based on distance from a simulated touchdown point (approximately  $1.3 \text{ ft/sec}^2$ ) to 20 knots. (See Reference 8 for a more complete description of the basic approach and flight director system).

Evaluators Four experienced helicopter certification test pilots performed the evaluations, three from the FAA and one from Transport Canada. A summary of their relevant experience is tabulated in Table 3.

#### Environmental Conditions

Relevant atmospheric conditions during the program varied from calm winds in smooth conditions to winds gusting from 15 to 20 knots with moderate turbulence. The last *fly off* sequence of three configurations - conventional, force (4 + 0) and deflection (4 + 0), were flown in rapid succession to ensure common wind conditions for each pilot's evaluation.

#### Pilot Ratings

The results of the pilot ratings for each manoeuvre are plotted in Figures 13 to 23.

Hover Pilots were able to perform this task to acceptable accuracy with all controller configurations. Figure 13 indicates that pilots preferred all of the force sensing controller configurations, except the (3 + 1)p configuration, even over the conventional configuration.

Reducing the level of integration of the force controller offered no apparent advantages. The deflection controller configurations were the least acceptable ones for this task, with some improvement in handling qualities available by reducing the integration level to the fully distributed case (2 + 1 + 1).

Landing Figure 14 indicates that three configurations of the force controller were preferred in this manoeuvre with the deflection controller configurations least preferred. With all configurations, this task was performed to satisfactory performance levels. Reducing the integration level of either of the hand

controllers did not provide significant workload relief.

Sidestep In this manoeuvre (Figure 15), conventional controls and the force controller configurations were preferred, with very slight preference given to the reduced integration level configurations of the force controller.

Divided Attention Hover Figure 16 indicates a marked preference for the force controller configurations. The deflection controller configurations were rated at least as good as the conventional controls.

Pirouette The fully integrated force controller was preferred for this task (Figure 17), even over configurations where the integration level was reduced with this controller. On the other hand, with the deflection controller, although rated poorest, some benefit is apparent in reducing the integration level.

Figure Eight Figure 18 indicates that conventional controls and the fully integrated force controller were rated best for this manoeuvre. Reducing the level of integration on the force controller appeared to degrade the handling qualities slightly. Again, the deflection controller was rated the poorest with some benefit provided when integration level was reduced.

Quick Stop This manoeuvre was the only one in which the conventional controls were preferred over all other configurations (Figure 19). However, the force controller was rated only slightly poorer with no apparent benefits provided by reducing integration level. The deflection controller was rated much poorer (bordering on unacceptable) but significant improvements were apparent when the integration level was reduced.

Slope Landing In this task (Figure 20), the force controller configurations were preferred again with no benefit provided by reduced integration level. The handling qualities with the deflection controller were significantly degraded with obvious improvements when the integration level was reduced. The 2 + 1 + 1 configuration with this controller was rated the same as with conventional controls.

Obstacle Clearance Takeoff and Steep Approach The force controller with the lowest level of integration was rated best for this task (Figure 21). However, conventional controls and the force controller with higher levels of integration were rated only slightly poorer. With the deflection controller, marked improvements were apparent at reduced integration levels, to the point that the 2 + 1 + 1

configuration was almost as good as with the force controller.

IFR Decelerating Approach Results of pilot ratings for the IFR tracking task are shown in Figure 22. Two evaluators judged the force controller to be better than conventional controls – one rated both the same and one rated the force controller one rating poorer, but felt that the force controller reduced pilot workload and was optimized with the flight director control laws. The deflection controller was rated poorest by all evaluators, primarily due to poor breakout/gradient force characteristics.

Autorotation Entry Fully integrated side-arm controllers were rated poorest for autorotation (Figure 23). The dominant complaint was a lack of collective position feedback cue on initial collective application. Thereafter, the force controller characteristics were adequate in providing reasonable control of rotor rpm, a factor lacking in the deflection controller because of poor breakout/gradient force characteristics.

Learning Trends In order to highlight learning trends, pilot ratings of the first and last exposure to a particular configuration are shown in Figure 24 for the conventional controls, fully integrated force control and fully integrated displacement control configurations. The reader is reminded (Table 2) that two pilots experienced all integration levels of the force-sensing controller before being introduced to the deflection-sensing controller. The reverse is true for the other two pilots. No noticeable differences in final assessments could be attributed to these different evaluation sequences. Also, these investigations were not necessarily performed in the same atmospheric conditions for each evaluator. The data in Figure 24 shows that the displacement controller configurations displayed the largest learning curve effect with a typical 1 HQR improvement for most tasks over the training length of the experiment. The ratings for the quickstop, however, show no improvement for this controller, suggesting either that much more training was necessary or that the characteristics of the controller combined with that task were especially unsuitable. (The latter was confirmed by pilot comments).

The 4 + 0 force controller learning curves are in general shallow and similar to the conventional controller trends. This similarity, and pilot comments regarding learning curve effects, suggests that pilots adapted to the 4 + 0 force controller was easily adapted to for most tasks.

The data in Figure 24 for pirouette and figure 8 tasks should be highlighted. These two tasks involve considerable multi-axis control which has been cited as a possible limitation for sidearm controllers. The fact that both controllers demonstrated steep learning curves for exposures on the order of a few hours and that the force controller final ratings were as good as conventional controls, dispels this reservation regarding side-arm controllers. It also points out that adequate training is necessary for proper evaluation of these devices.

#### Pilot Comments

In general, all evaluators felt that the basic aircraft characteristics represented typical helicopter handling qualities. However, most evaluators suggested the fixed horizontal stabilizer resulted in extreme pitch attitudes when the aircraft tail was turned into wind.

Conventional Controls Pilots cited some deficiencies in the conventional control configuration. Two of the evaluators had difficulty in yaw axis control and stabilization. It is felt that this difficulty stemmed from two factors, non-optimum pedal force characteristics coupled with a yaw axis system which had dynamics significantly different from a conventional unaugmented helicopter yaw axis. This interaction caused the two evaluators to have problems obtaining smooth and consistent control of the yaw axis. A typical comment was "jerky" or "steppy" in yaw. While the other two evaluators did not highlight this deficiency, possibly because they adapted to the system more quickly, these pilots did miss the lack of a force trim release system on the conventional cyclic and disliked the higher than "normal" cyclic stick forces that they experienced. Despite these deficiencies, all four evaluators rated the configuration as certifiable and, as indicated above, *typical*.

Force Sensing Side-Arm Controller Evaluators were impressed, even on first exposure to this control system, with the ease at which they could perform stabilization tasks with this controller. The integral trim system allowed precise modulation of the aircraft controls and alleviated the requirement for the pilot to continually concern himself with aircraft trim, even in rapidly changing wind/heading conditions. The learning curve was assessed as steep for all configurations using this controller and, with the exception of three evaluations of marginal certifiability due to yaw axis/wind difficulties in the pirouette manoeuvre, all configurations incorporating the force sensing controller were assessed as certifiable. Deficiencies cited for the force sensing side-arm controller were as follows:

- 1) In some manoeuvring tasks, the quickstop, the obstacle clearance takeoff and steep approach and the autorotation – evaluators would appreciate better control position feedback cues, especially in the collective axis.
- 2) Some evaluators initially complained of inter-axis control coupling on early exposures to the controller; however, these complaints were not received during later evaluations, suggesting that this could be a learning curve related effect.
- 3) For all levels of controller integration, comments regarding the slope landing task, which was rated as a marginal Level 1 handling qualities manoeuvre, highlighted the need for better indications of the rotor tip-path-plane. Improved control position indicators could possibly meet this need.

Deflection-Sensing Side-Arm Controller This control configuration was rated the poorest of all configurations for all the tasks. No significant benefits were perceived from the small controller deflections that provided a level of control position feedback to the evaluator, or perhaps any such benefits were masked by other deficiencies. The dominant deficiency appeared to be poor breakout/gradient force characteristics of the controller. It is worthy of note that this same controller was rated much better in previous work at the NAE (Ref. 3) where cyclic pitch breakout force was 26% less and pitch gradient 77% greater, and where lateral cyclic breakout force was 24% less and lateral gradient was 126% greater. With the poor breakout/gradient characteristics, reducing the level of controller integration (number of axes) on the controller resulted in significant benefits in improved workload. This effect was not as noticeable, however, on the force sensing controller which had nearly optimum force characteristics.

In addition to the poor physical characteristics of the displacement controller, which were cited by all four evaluators, any deficiencies described for the force sensing controller were usually repeated for this controller as well.

Reduced Integration Levels Pilot comments directly related to the integration level of the side-arm controller displayed a number of tendencies:

- 1) As described above, for a controller with poor physical characteristics, any reduction in integration level improved the vehicle handling qualities.
- 2) The (3 + 1)c configuration provided only a slight improvement in vehicle handling

qualities, even at the earliest stages of the pilot learning curve on side-arm controllers.

- 3) At least two of the evaluators consistently preferred yaw axis control on the side-arm controller rather than the (3 + 1)p configuration. Generally, if a single axis split is required, the consensus was that collective should be the separated control.

### Conclusion

The following conclusions can be drawn from this experiment:

- a) The use of integrated 4-axis side-arm control is a viable option for civil rotorcraft operations, even when used with very low levels of stability and control augmentation such as represented in this experiment.
- b) Pilot workload level and performance for configurations with the force sensing 4 + 0 controller was as good or better than with conventional controls for most tasks and, with the provision of improved control position information to the pilot, this type of control has the potential for further improvement in handling qualities.
- c) The breakout/gradient force characteristics and sensitivities of side-arm controllers may dominate aircraft handling qualities. A systematic evaluation of a range of these characteristics for all representative tasks is required to establish satisfactory boundaries for both force-sensing and deflection-sensing controllers. This would provide much needed guidance to manufacturers of such systems.
- d) A number of certification issues were suggested by the evaluators. Most of these would be addressed in the incorporation of fly-by-wire technology such as:

- fault/failure analysis to ensure redundancy
- provision for monitoring coupled systems
- testing for electro-magnetic interference

Some issues directly relevant to integrated side-arm control are:

- definition of acceptable characteristics as in c) above

- definition of acceptable aircraft dynamic stability in relation to integrated side-arm control
- establishing pilot/co-pilot control priority in dual pilot operations
- the enhancement of control position or tip path plane cues to the pilot

Overall, the force sensing 4 + 0 controller was preferred for most manoeuvres over the conventional control configuration.

### References

1. Sinclair, S.R.M., Morgan, J.M. An Investigation of Multi-Axis Isometric Side-Arm Controllers in a Variable Stability Helicopter. National Research Council Canada, NAE LR-606, August 1981.
2. Morgan, J.M. A Piloted Experiment in the Use of Multi-Function Side-Arm Controllers in a Variable Stability Helicopter. Ninth European Rotorcraft Forum, Stresa, Italy, September 1983.
3. Morgan, J.M. A Comparison Between Various Side-Arm Controller Configurations in a Fly-by-Wire Helicopter. 44th Annual Forum at the American Helicopter Society, June 1988.
4. Morgan, J.M., Lippay, A.L. et al. Helicopter Flight Control with One Hand. Canadian Aeronautics & Space Journal, Vol. 31, No. 4, December 1985.
- Morgan, J.M. In-Flight Research into the Use of Integrated Side-Stick Controllers in a Variable Stability Helicopter. The Royal Aeronautical Society International Conference on Helicopter Handling Qualities and Control, London, U.K., November 1988.
6. Sattler, D.E. The National Aeronautical Establishment Airborne Simulation Facility. National Research Council Canada, NAE Misc 58, May 1984.
7. Cooper, G.E., Harper, P.R., Jr. The Use of Pilot Rating in the Evaluation of Aircraft Handling Qualities, NASA TN D-5153, April 1969.
8. Baillie, S., Kereliuk, S., Hoh, R. An Investigation of Lateral Tracking Techniques, Flight Directors and Automatic Control Coupling on Decelerating IFR Approaches for Rotorcraft. National Research Council Canada, NAE-AN-55, October 1988.

**TABLE 1: Controller Characteristics**

	Breakout	Gradient	Travel (+ / -)	Sensitivity	Integral
<b>Conventional</b>					
Pitch	0.5	1.0	6.0	.46	0
Roll	0.25	1.0	6.5	.31	0
Yaw	7.0 (lb)	15.0 (lb/in)	4.5	.53 (unit/in)	0
Collective	adjustable friction	0.0	5.35 (in)	.29 (unit/in)	0
<b>Force Side-Arm</b>					
Pitch	0.3	15	0.5	.27	.125
Roll	0.3	15	0.5	.27 (units/lb)	.125
Yaw	0.75	∞	0.0	.09 (unit/in-lb)	0
Collective	0.075 (lb)	∞	0.0 (in)	.03 (unit/lb)	1.90
<b>Displacement Side-Arm</b>					
Pitch	2.3	0.9	15°	.26	0.5
Roll	1.3	0.10	17°	.12	0.05
Yaw	1.9 (in-lb)	0.17 (in-lb/deg)	12°	.22 (unit/deg)	0.0
Collective	0.7 (lb)	2.2 (lb/in)	.5 (in)	see note below	0.50
<b>Displacement Side-Arm (Ref 3)</b>					
Pitch	1.7	.16			
Roll	0.95	.23			
Yaw	1.9 (in-lb)	.13 (in-lb/deg)			

Note: The displacement side-arm controller incorporated a non-linear sensitivity in the vertical axis where units =  $.4x^3 + 1x$  and  $x = 2 \times$  controller displacement (in).

**TABLE 2: Controller Configuration Sequences**

- 4 + 0 = 4-axis side-arm
- (3 + 1)c = 3-axis side-arm, conventional collective
- (3 + 1)p = 3-axis side-arm conventional pedals
- (2 + 1 + 1) = pitch roll side-arm, conventional pedals & collective

		<b>EVALUATOR</b>					
<b>A</b>		<b>B</b>		<b>C</b>		<b>D</b>	
Conventional		Conventional		Conventional		Conventional	
Force	(4 + 0)	Deflection	(4 + 0)	Deflection	(4 + 0)	Force	(4 + 0)
"	(3 + 1)c	"	(4 + 0)	"	(4 + 0)	"	(4 + 0)
"	(3 + 1)p	"	(3 + 1)c	"	(3 + 1)c	"	(3 + 1)c
"	(2 + 1 + 1)	"	(3 + 1)p	"	(3 + 1)p	"	(3 + 1)p
Deflection	(4 + 0)	"	(2 + 1 + 1)	"	(2 + 1 + 1)	"	(2 + 1 + 1)
"	(4 + 0)	Force	(4 + 0)	Force	(4 + 0)	Deflection	(4 + 0)
"	(2 + 1 + 1)	"	(3 + 1)p	"	(3 + 1)c	"	(3 + 1)c
"	(3 + 1)p	"	(3 + 1)c	"	(3 + 1)p	"	(3 + 1)p
"	(3 + 1)c	"	(2 + 1 + 1)	"	(2 + 1 + 1)	"	(2 + 1 + 1)
"	(4 + 0)	"	(4 + 0)	"	(4 + 0)	"	(4 + 0)
Force	(4 + 0)	Deflection	(4 + 0)	Conventional		"	(4 + 0)
Conventional		Conventional		Deflection	(4 + 0)	Force	(4 + 0)
						Conventional	

**TABLE 3: Evaluator Relevant Flying Experience**

Pilot	Total Time (hours)	Total Helicopter (hours)	Total Side-Arm (hours)
A	5800	3000	20 Research
B	4100	2400	400 Cobra
C	3500	3000	5 Cobra
D	9200	5700	5 Cobra

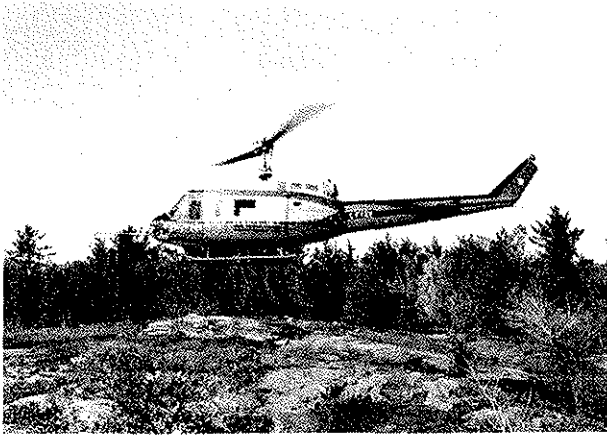

FIG. 1: THE NAE BELL 205 AIRBORNE SIMULATOR

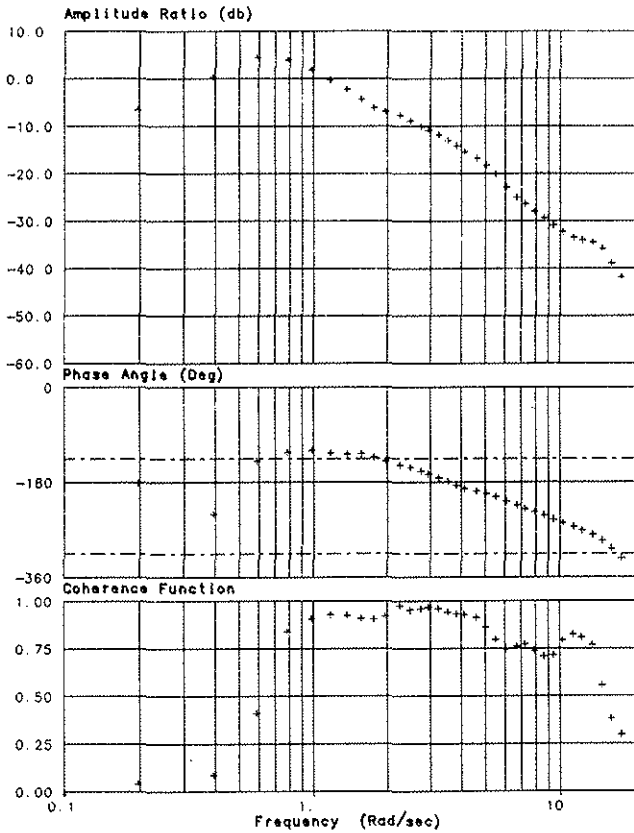

FIG. 2: PITCH AXIS BODE PLOT,  $\delta_\theta$  TO  $\theta$ (RAD) (HOVER FLIGHT CONDITION)

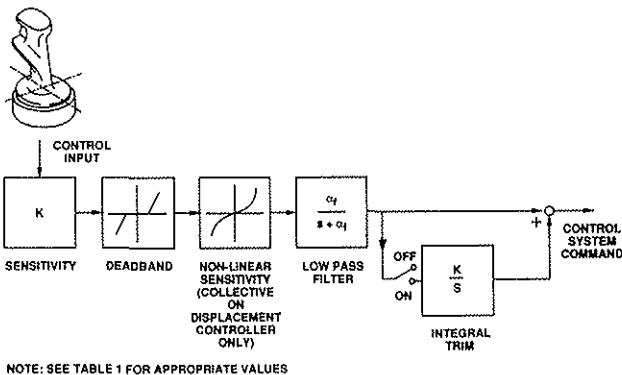

FIG. 4: CONTROL INPUT CONDITIONING

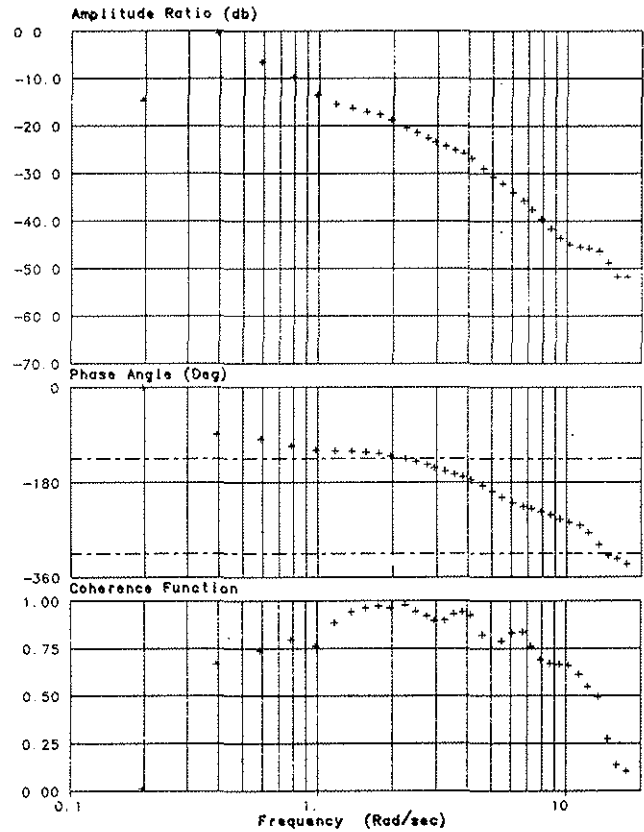

FIG. 3: ROLL AXIS BODE PLOT,  $\delta_\phi$  TO  $\phi$ (RAD) (HOVER FLIGHT CONDITION)

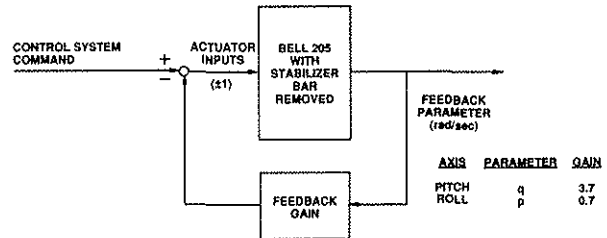
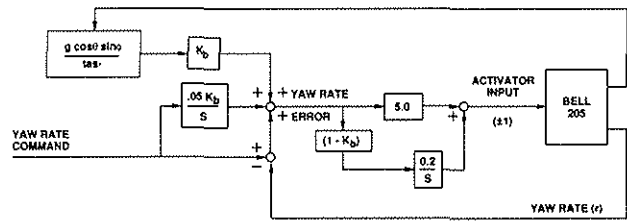

FIG. 5: PITCH AND ROLL CONTROL SYSTEM ARCHITECTURES



$v_{ts}$  = TRUE AIRSPEED LOWPASS-FILTERED @ 1 RAD/SEC

$K_b = 0$  FOR  $v_{ts} < 30kts$   
 $= 1$  FOR  $v_{ts} > 35kts$   
 $= 0 \rightarrow 1$   $30 < v_{ts} < 35$

FIG. 6: YAW AXIS CONTROL SYSTEM



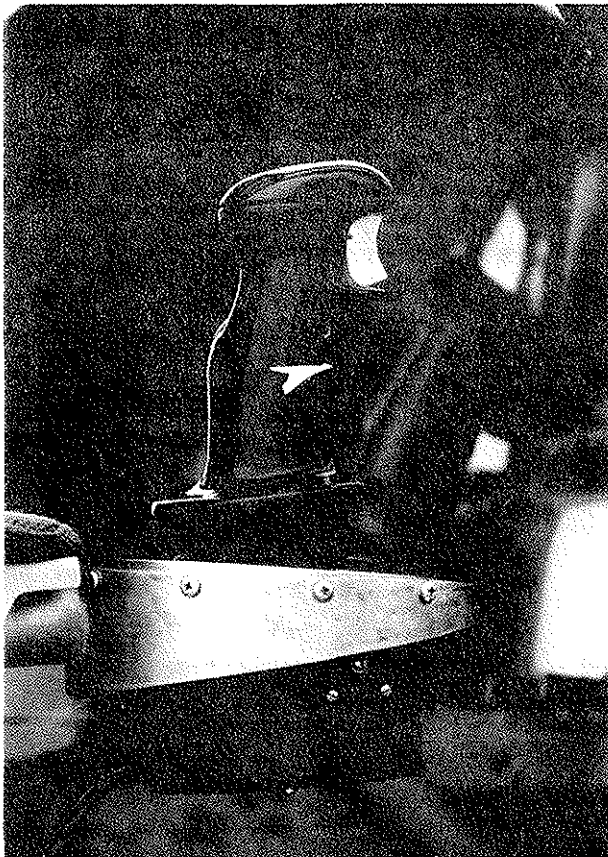
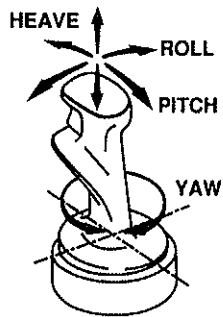

FIG. 7: FORCE SENSING SIDEARM CONTROLLER



FIG. 8: DISPLACEMENT SENSING SIDEARM CONTROLLER



4 + 0 - FULLY INTEGRATED

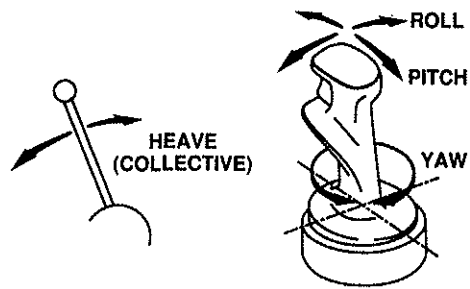

(3 + 1)c - SEPARATE COLLECTIVE

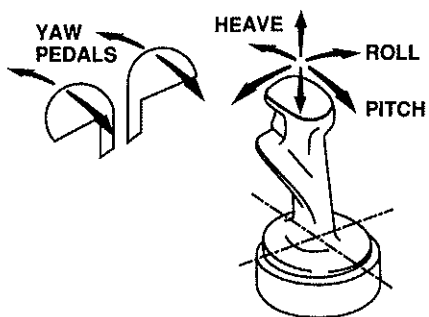

(3 + 1)p - SEPARATE PEDALS

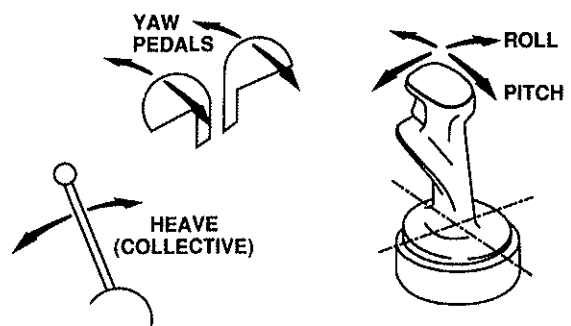

(2 + 1 + 1) - FULLY DISTRIBUTED

FIG. 9: CONTROLLER INTEGRATION LEVELS

Sidestick Applications in Civil Rotorcraft

Evaluation Pilot \_\_\_\_\_ Safety Pilot \_\_\_\_\_  
Flight Number 89- \_\_\_\_\_ File Numbers \_\_\_\_\_ Date \_\_\_\_\_  
MSI / CAE / CONV (4+0) / (3+1)c / (3+1)p / (2+1+1)  
Cooper Harper Handling Qualities Ratings and Comments

---

---

Precision Hover

---

---

Vertical Landing

---

---

Sidestep

---

---

Divided Attention Hover

---

---

Pirouette

---

---

Figure 8

---

---

Quickstop

---

---

Slope Landing

---

---

Obstacle Clearance Takeoff/Steep Approach

---

---

\*\* Based on the handling qualities demonstrated during this flight, would you issue certification for this configuration (yes, marginal or no)? If your response is marginal or no, which manoeuvres drove you to this decision and what should be improved on the configuration to allow its certification?

What part did the current wind and turbulence conditions play in your evaluation?

FIG. 10: EVALUATOR QUESTIONNAIRE

Name: \_\_\_\_\_

**GENERAL COMMENTS ON FAA/NAE  
SIDEARM CONTROLLER EXPERIMENTS**

1. Please provide general comments on each control configuration which you have flown, in particular, an assessment of certifiability, control deficiencies and whether you feel that modifications are possible to correct these deficiencies or improve the controller.
  
2. Tasks were selected for this program with two aims in mind, one was to represent typical manoeuvres in addressing certification standards, but others were included in an attempt to highlight possible deficiencies when integrating control functions on one controller. Please comment on the adequacy of the selected manoeuvres in achieving these two aims.
  
3. What major advantages do you feel could be gained with the use of sidearm controllers in civil rotorcraft?
  
4. Based on the best controller configuration which you experienced, what improvements would you suggest?
  
5. If you were presented a vehicle for certification which incorporated a sidearm controller (not necessarily one of the configurations presented in this experiment) based on your current experience on sidearm controllers, what major issues would you concentrate on during the flight tests?
  
6. Any additional comments? (Please use the back of this page)

**FIG. 11: GENERAL QUESTIONNAIRE**

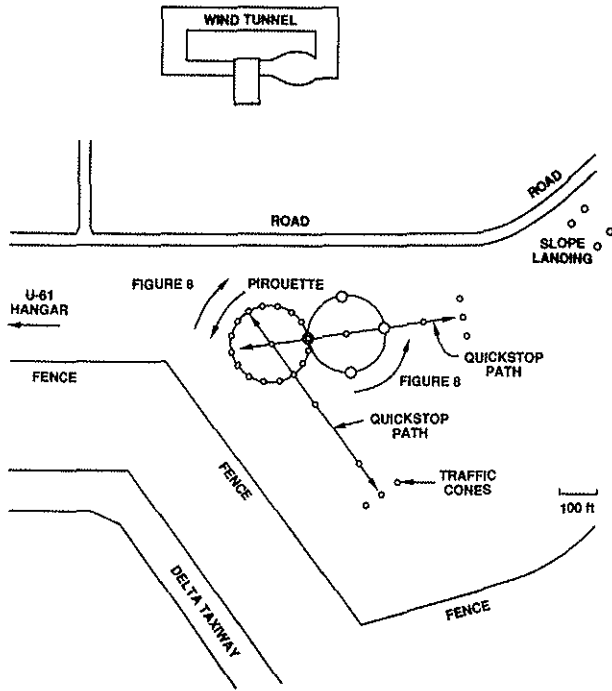

FIG. 12: EVALUATION COURSE

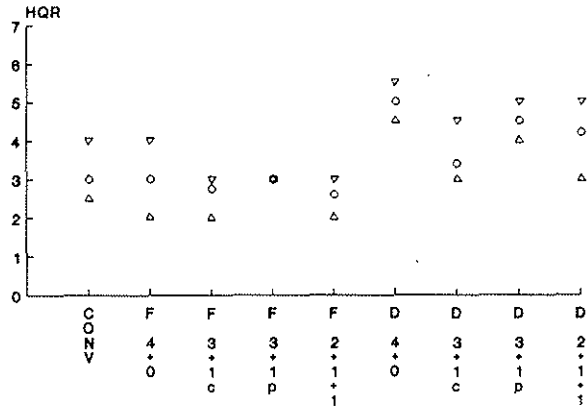

FIG. 15: SIDESTEP RATINGS

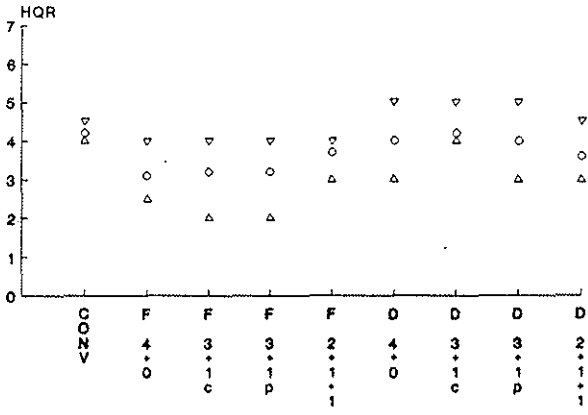

FIG. 16: DIVIDED ATTENTION HOVER RATINGS

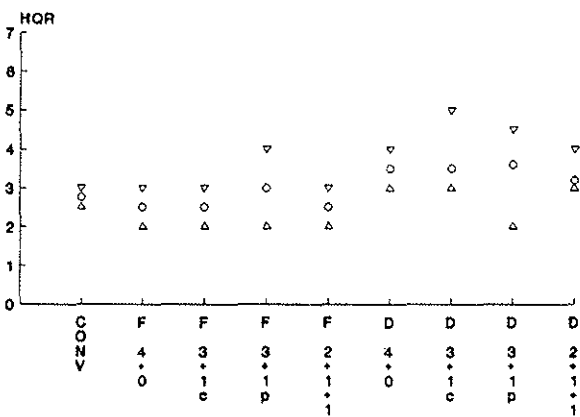

FIG. 13: HOVER RATINGS

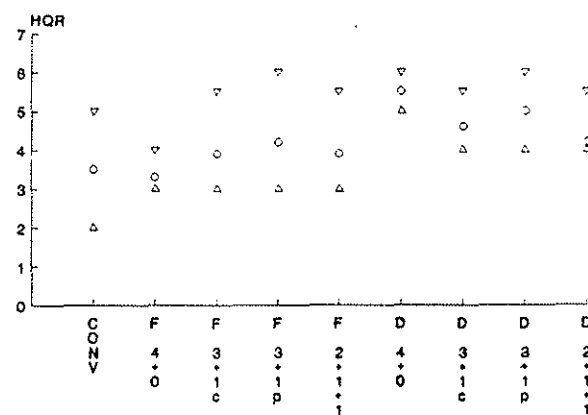

FIG. 17: PIROUETTE RATINGS

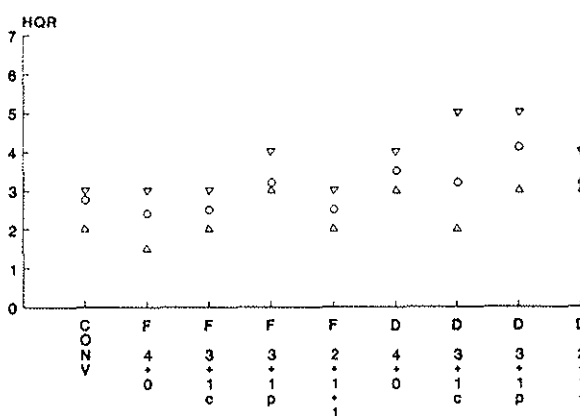

FIG. 14: LANDING RATINGS

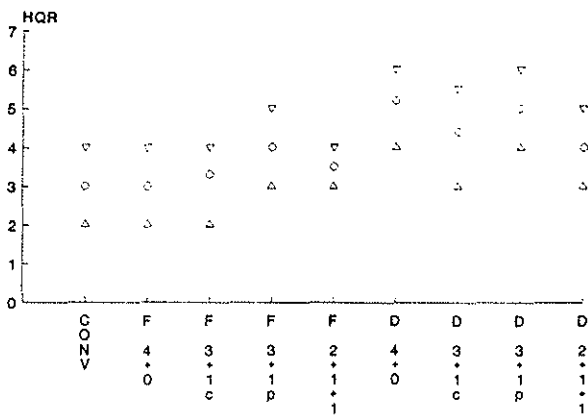

FIG. 18: FIGURE EIGHT RATINGS

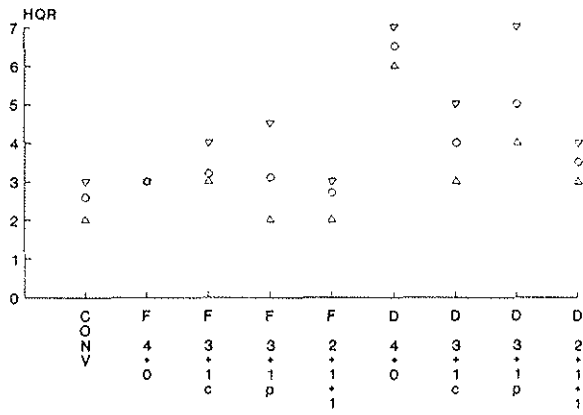

FIG. 19: QUICKSTOP RATINGS

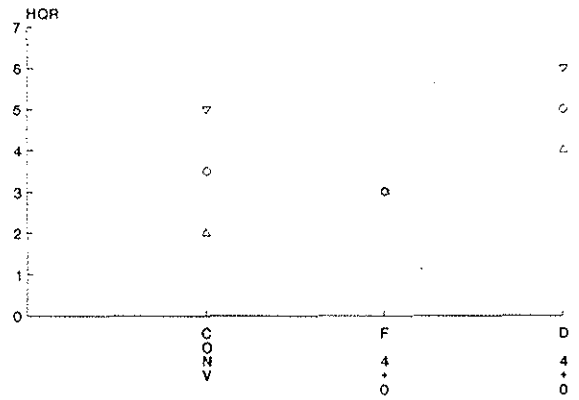

FIG. 22: IFR DECELERATING APPROACH RATINGS

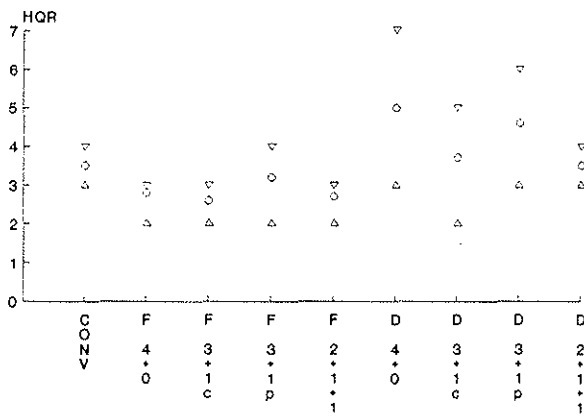

FIG. 20: SLOPE LANDING RATINGS

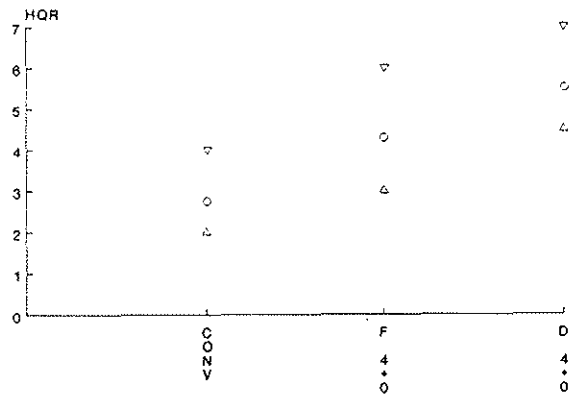

FIG. 23: AUTOROTATION RATINGS

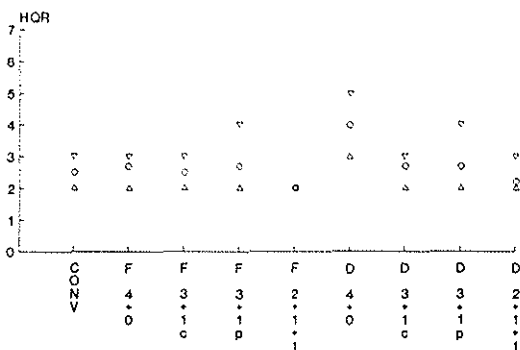

FIG. 21: OBSTACLE CLEARANCE TAKEOFF AND STEEP APPROACH RATINGS

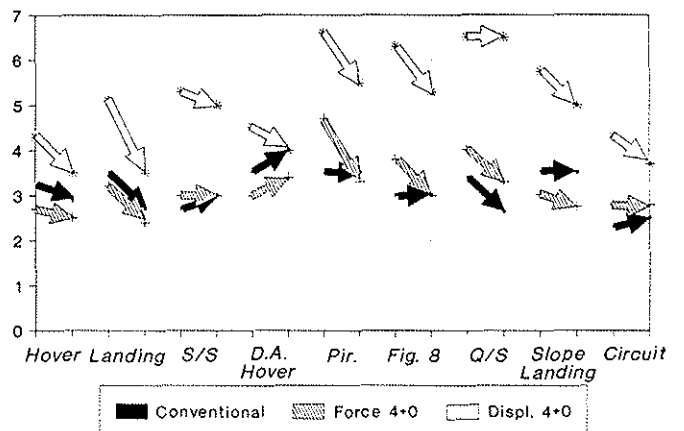

FIG. 24: LEARNING TRENDS ON INTEGRATED SIDEARM CONTROLLERS