

OSCILLATIONS OF AN ANISOTROPIC ROTOR

ON AN ELASTIC ANISOTROPIC SUPPORT

by Yu. A. Myagkov

Mil Design Bureau

(Moscow)

The paper considers small oscillations of the rotor blades possessing anisotropic properties in conjunction with an elastic support oscillations. Among these rotors are two-bladed and single-bladed ones of wide application as well as multi-bladed ones with non-uniform positioning of the blades over a rotor disc. The example is two two-bladed coaxial rotors having an arbitrary angle in plan between them. The blades have a non-zero angle of setting and an arbitrary principle of a geometrical twist which defines its oscillation coupling in two planes. The rotor hub is able to move in a plane of revolution owing to the elastic support deformability. Under anisotropy of the support elastic properties an equilibrium of such rotors oscillation modes in conjunction with the support is possible only under a polyharmonic nature of motion.

To compare structures of a support dynamic response vector $\vec{\Phi}$ and a rotor centre deflection vector $\vec{\delta}$ let us specify the latter vector for a rotary frame of axes as

$$\vec{\delta}_\omega = \vec{\delta}_p e^{i\omega t}, \quad \vec{\delta}_p = \begin{Bmatrix} X_k \\ Z_k \end{Bmatrix}$$

The vector transformation into a stationary frame of axes gives the following expression:

$$\vec{\delta} = \Delta_{\omega}^{-1} \vec{\delta}_{\omega} = (G e^{-i\omega t} + G' e^{i\omega t}) \vec{\delta}_{\omega}$$

where the matrix G has a form

$$G = \begin{vmatrix} \frac{1}{2} & -\frac{1}{2i} \\ \frac{1}{2i} & \frac{1}{2} \end{vmatrix}$$

$\|G'\|$ is a transposition matrix, and matrix Δ_{ω}^{-1} is a coordinate transformations.

The elastic support dynamic response vector to a given deflection has a form

$$\vec{\Phi} = \|C\| \vec{\delta},$$

$$C = \begin{vmatrix} A(p) & H(p) \\ H(p) & B(p) \end{vmatrix}$$

Matrix $\|C\|$ is a support dynamic stiffness coefficients matrix which elements are the functions of frequency p .

Vector $\vec{\Phi}$ transformation into the rotary frame of axes gives the following form of the support dynamic response vector:

$$\begin{aligned} \vec{\Phi}_\omega &= \Delta_\omega \vec{\Phi} = \Delta_\omega \|C\| \Delta_\omega^{-1} \vec{\delta}_\omega = \\ &= \left\{ [G \|C(p_1)\| G + G' \|C(p_2)\| G'] e^{ipt} + \right. \\ &\quad + [G \|C(p_2)\| G'] e^{i(p+2\omega)t} + \\ &\quad \left. + [G' \|C(p_1)\| G] e^{i(p-2\omega)t} \right\} \vec{\delta}_p \end{aligned}$$

where $p_1 = p - \omega$, $p_2 = p + \omega$.

The stated above provides that the dynamic response of the anisotropic support contains combinative harmonics in addition to a component having a frequency of the given deflection.

For the case of an anisotropic support the two components of the dynamic response vector with combinative frequencies $p \pm 2\omega$ are reduced to zero, and this restricts the probable equilibrium state of the system to frequency p only.

Taking into account the particular condition of combinative harmonics formation with the frequency shift by $\pm 2\omega$ it is advisable to present the hub centre deflection vector structure in a form of harmonic series with a frequency step 2ω .

Moreover if the frequencies multiple to rotor revolutions only are of interest one can get two series comprised of even and odd harmonics:

$$\vec{\delta}_\omega = \sum_{p=k\omega} (\vec{\delta}_p e^{ipt}) \quad \begin{aligned} \pm k &= 0, 2, 4, \dots \\ \pm k &= 1, 3, 5, \dots \end{aligned}$$

When considering the equilibrium of the rotor combined with the support for the adopted structure of the vector $\vec{\delta}_\omega$ under the action of external forces affecting the hub in the revolution plane, we have:

$$\vec{\Phi}_\omega + \vec{R}_\omega = \vec{F}$$

where \vec{F} is an external load vector,

$\vec{R}_\omega = \|D_\omega\| \vec{\delta}_\omega$ is a dynamic response vector of the rotor blades, and

$\|D_\omega\|$ is a dynamic stiffness matrix for the rotary frame of axes;

and providing the equilibrium conditions for an every harmonic force component on the hub, we can get a set of algebraical equations for amplitude components $\vec{\delta}_p$ of every even and odd harmonics series.

The mentioned equilibrium is satisfied with an accuracy up to the value of two omitted items in the support response with frequencies beyond the harmonic range $k_{min} \rightarrow k_{max}$ under consideration, that is $(k_{min} - 2)$ and $(k_{max} + 2)$.

This circumstance should be taken into consideration when choicing the amount of series items (frequency range) and positions of k_{max} or k_{min} with respect to the particular number of a harmonic under consideration, which enables to acquire the desired accuracy of the solution for practical application.

The system of equations in a generalized form may be written as

$$\|Q\| \cdot \vec{\delta}_k = \vec{f}_k$$

where $\vec{\delta}_k$ is a vector of deformation harmonic amplitudes, and \vec{f}_k is a vector of load harmonic amplitudes, the matrix $\|Q\|$ is comprised of three diagonals with 2×2 -assemblies arising from $\|C\|$ and $\|D\|$ matrix elements and takes the following form

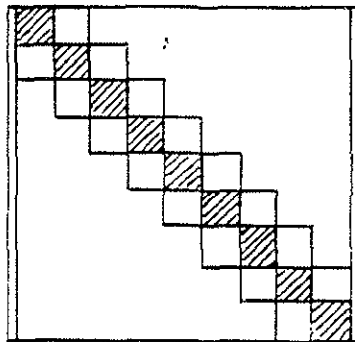

The part of the matrix for even harmonics, for 4 particularly, takes the form:

$G C(3\omega) G'$	$G C(3\omega) G +$ $+ G' C(5\omega) G' +$ $+ D\omega(4\omega)$	$G' C(5\omega) G$
-------------------	--	-------------------

The matrix $D_\omega(p)$ takes the form

$$D_\omega = \begin{vmatrix} 2(p^2 + \omega^2)\Delta m_x & -4i\omega p \Delta m_x \\ 4i\omega p \Delta m_x & 2\left[(M_B + \Delta m_x)\frac{4\omega^2 p^2}{p^2 + \omega^2} - (p^2 + \omega^2)M_B\right] \end{vmatrix}$$

where M_B is a blade mass.

$\Delta m_x(p)$ is an additional mass determined by a solution of the problem on natural oscillation of a blade for a model shown in fig.1.

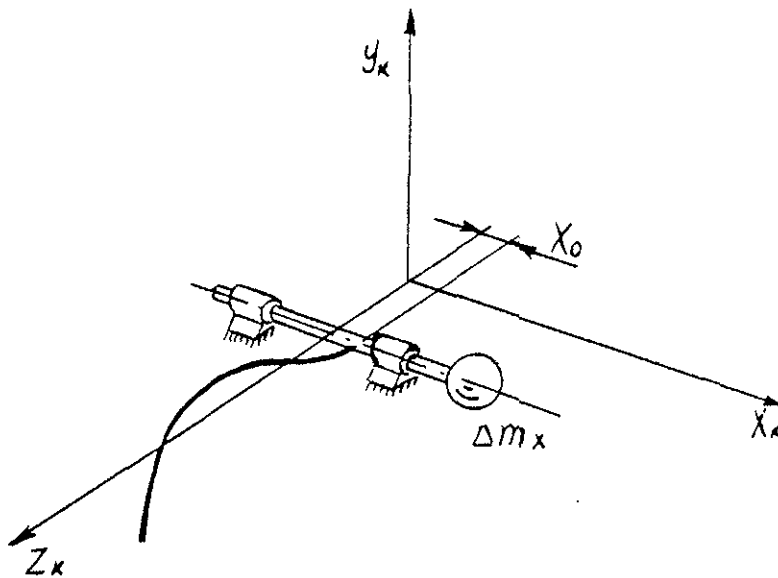

Fig.1.

The stated method was applied to study the resonance properties of a two-bladed rotor. The results are presented as relationship between an amplitude spectrum of deformation harmonics and an angular speed of rotation (fig.2) and in the form of the traditional resonance diagrams (fig. 3,4). The load on the hub was specified as normalized vectors of diverse orientation. The obtained relationships allow to evaluate the resonance states of the system as well as the oscillation modes.

The oscillations with frequencies of some harmonics distinguished by 2ω and 4ω from the frequency of external load and from frequency of the dominant component were arised in such resonance states. Resonance peaks on components adjacent to the dominant one are named here echo-resonances. Among the cross excited oscillations of interest also are oscillations with the frequency of 2ω , excited by a constant load due to mass or aerodynamic disbalances.

The resonance diagrams on fig.3 and 4 correspond to two values of the support anisotropy level and the equal mean value of stiffness.

$$\Delta \bar{C} = \frac{\Delta C}{2C_0} = 0,15 \text{ and } 0,65$$

The difference between a low anisotropy case and an isotropy case shows itself basicly in two diverse oscillation modes with frequencies of $p \pm \omega$ corresponding to minimum and maximum of support stiffness. The echo-resonances are practically lacking and can be exposed only by means of particular diagnostics.

For a high anisotropy case, $C = 0.65$ (fig.4), the echo-resonances become commensurable with the main ones, and some oscillation modes combine three and even four harmonics. The points corresponding to the resonance peaks are grouped along

directions of combinative harmonics and produce a developed system (net) of resonance states. At these points ellipses representing the mechanical trajectory of the rotor centre in a normalized form at a given frequency are shown. The orthogonality between load mode and motion (trajectory) mode belonging to the particular oscillation tone may result in the "absence" of some resonance peak. This fact should be remembered when an analytical study and full scale diagnostics of rotor dynamics are carried out.

It should be noted also the appearance of an additional blade oscillation tone located between two combinative harmonics of $(p_{\min} + \omega)$ and $(p_{\max} + \omega)$. For this tone the ellipse orientation of the rotor centre trajectory is opposite to the orientation of the main tone.

The results of analytic investigations on resonance conditions occurring in so-called X-shaped rotor constructed as two coaxial two-bladed rotors with an angle in plan between them taken to be arbitrary are presented here as an example of similar research in anisotropy rotor dynamic properties. The support properties are considered to be isotropic to make the perception easier.

In this case the matrix $\|D_x\|$ of dynamic stiffness was derived by similitude transformation of the matrix $\|D_\omega\|$ into rotor symmetry axes with rotating through the angle of $\alpha/2$ and followed by summation.

$$D_x = \sum \Delta \cdot D_\omega(\rho) \cdot \Delta^{-1}$$

Fig. 5 shows a resonance diagram for the particular case of $\alpha = 90$ degrees, when the rotor becomes isotropic.

The two of the oscillation modes under consideration are based primarily on the blade bending at different signs of deflection occurring in the tip blade and the hub (blade tone) and the other two modes are based primarily on the deformability of the support with bending in the direction of the hub deflection. The frequency of the lower oscillation mode decreases up to zero and this manifests the critical rotation speed. For all the oscillation modes the trajectories of the rotor centre are circular, but one of each couple has precession direction coinciding with the rotor rotation direction and the other two are directed oppositly (shown by a

dotted line). As mentioned above the diverse load form is required for their excitation.

Fig. 6 shows the generalized resonance diagram which displays a family of curves corresponding to a gradual altering of the angle α between blades from described position of $\alpha = 90$ degrees up to the value of $\alpha = 0$ degrees, when rotor becomes two-bladed. For simplification the ellipses are not shown. The significant change in resonance frequencies depending on the angle value is observed. The motion trajectories for the both blade tones are elliptic with opposite orientation of principal axes. The mentioned tones are excited almost identically by loading modes being typical for the full-scale conditions. This fact arises additional difficulties when designing.

Conclusions

The solution of the problems dealing with an oscillation conditions in a rotor on a support possessing anisotropic properties is realised provided the trajectory of a rotor centre be presented as a polyharmonic series with a step in frequency equal to 2ω . Such an approach enables to reduce the problem solution to a system of a linear algebraic equations. The choice of the amount of the items in series provides the desired accuracy demanded for a practical application. The due regard for anisotropic properties of the rotor and the support results in significantly more precise location of the resonance frequencies and specify more accurately the motion character.

$$\underline{\Delta\bar{c} = 0,65}$$

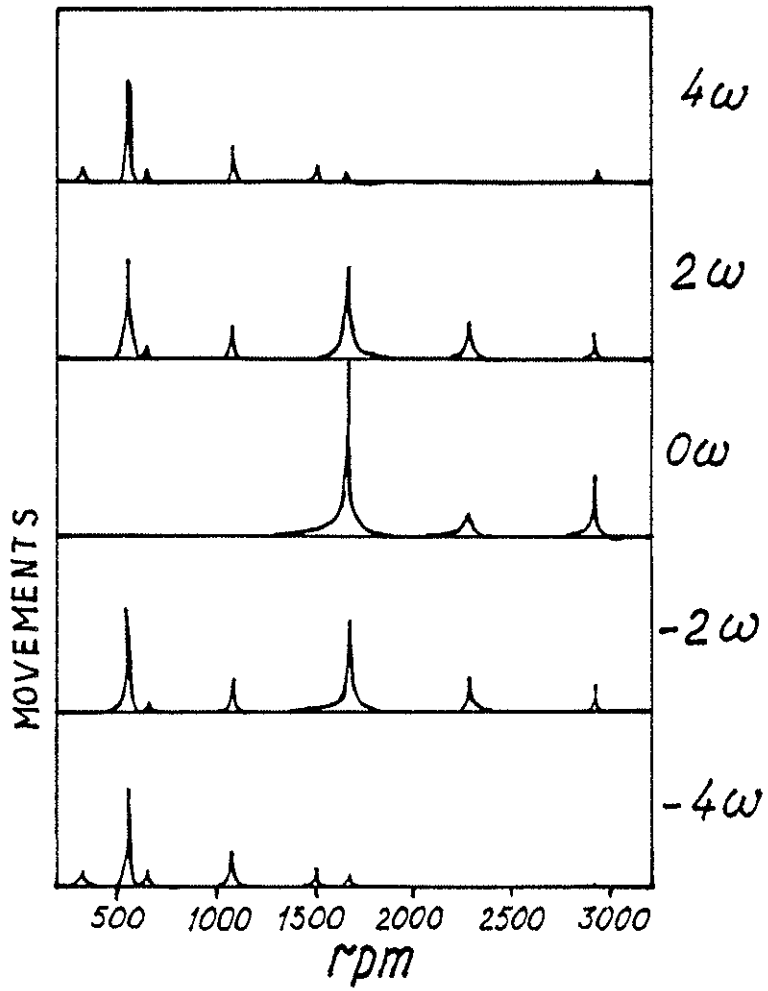

Fig. 2

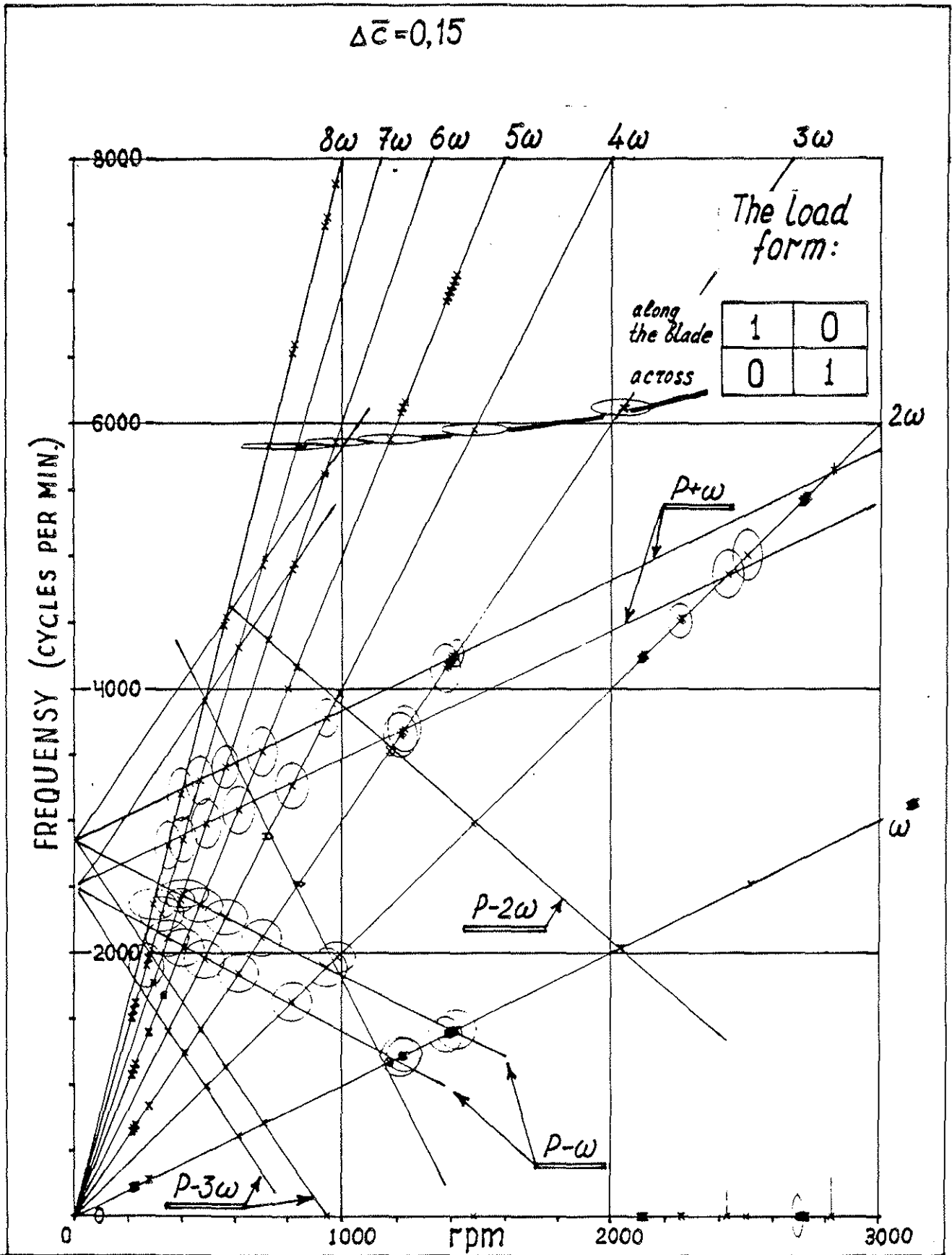

Fig. 3

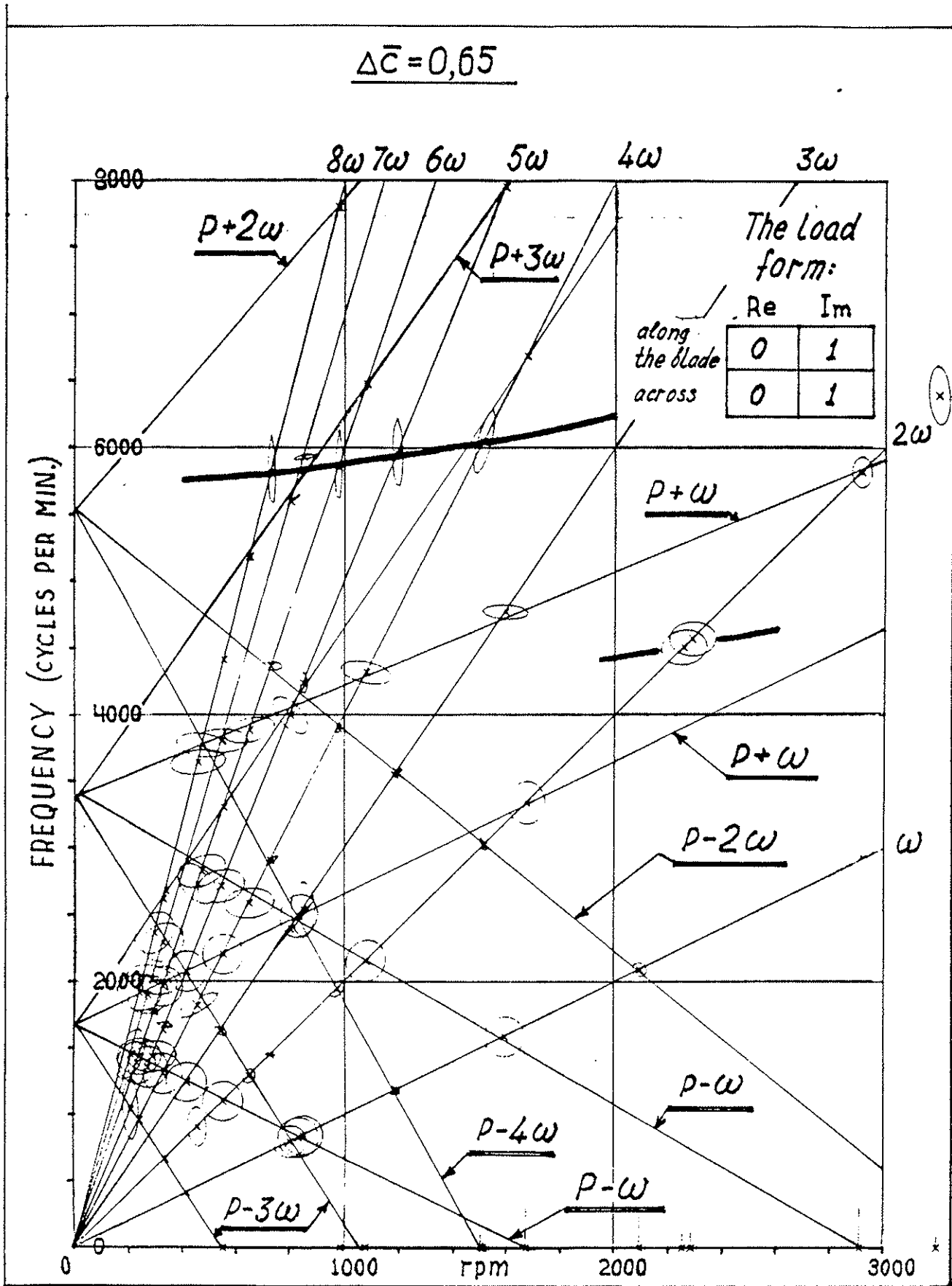

Fig. 4

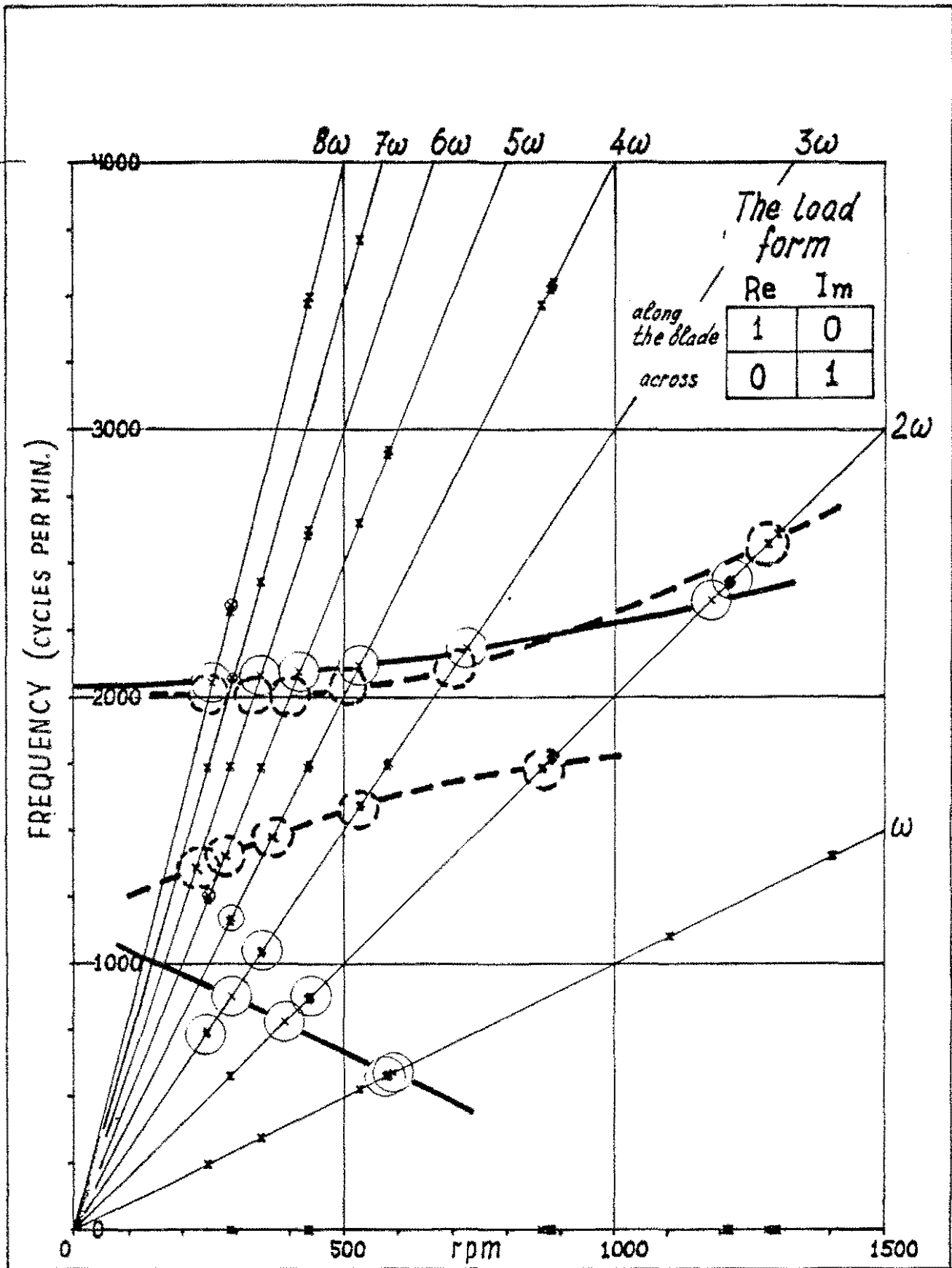

Fig. 5

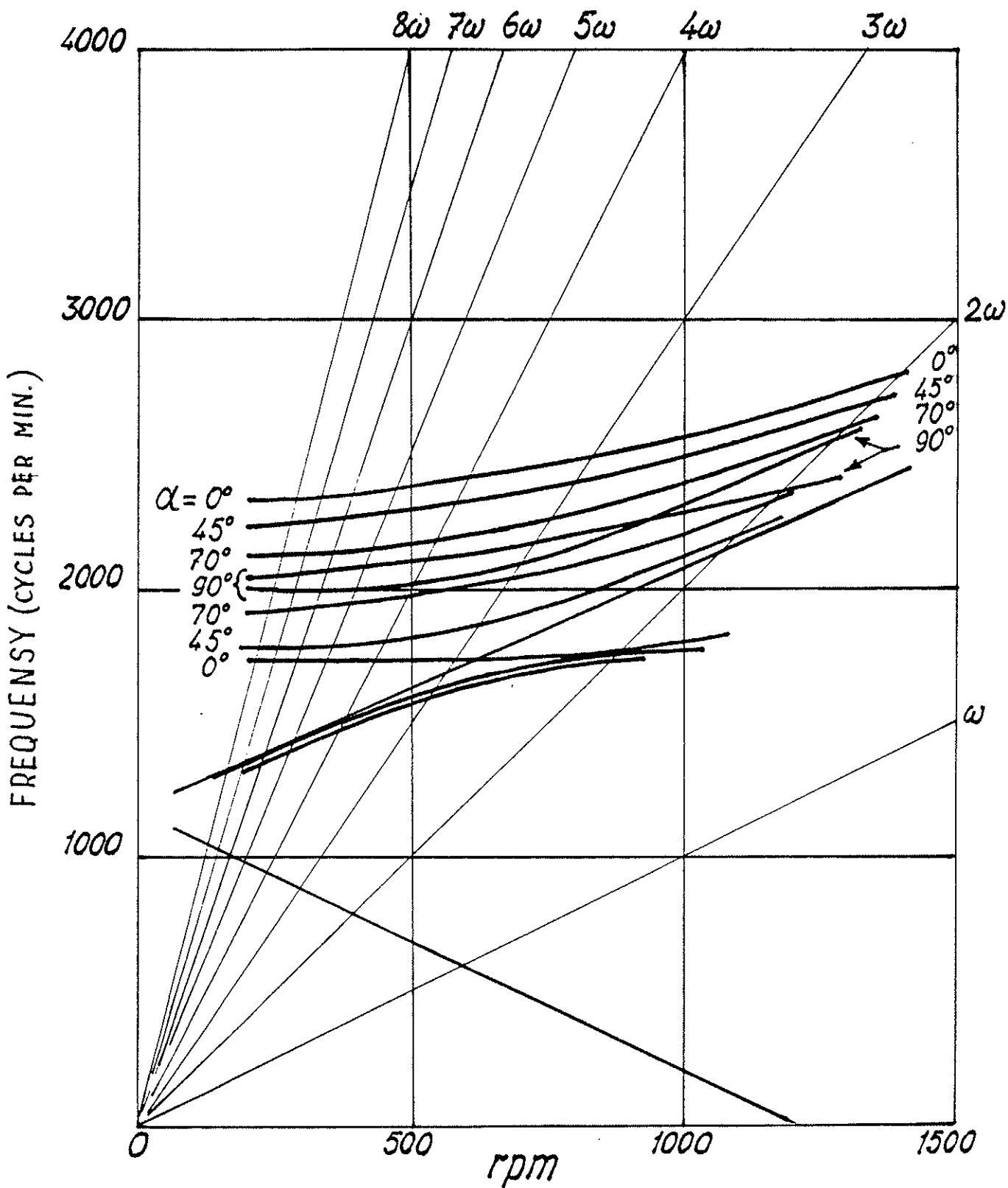

Fig. 6