

A FIXED FREQUENCY ROTOR HEAD  
VIBRATION ABSORBER BASED UPON G.F.R.P. SPRINGS

by

R W WHITE  
WESTLAND HELICOPTERS LTD  
YEOVIL SOMERSET ENGLAND

FIFTH EUROPEAN ROTORCRAFT AND POWERED LIFT AIRCRAFT FORUM  
SEPTEMBER 4 - 7 TH 1979 - AMSTERDAM, THE NETHERLANDS

A Fixed Frequency Rotor Head Vibration  
Absorber based upon G.F.R.P. Springs

R.W. White  
Westland Helicopters Limited

SUMMARY

Rotor induced vibration is a major environmental factor in helicopter operations. Whilst efforts are made at the design stage to overcome the problem with careful design of rotor and fuselage it is sometimes necessary to fit parasitic devices such as vibration absorbers.

An attractive place to fit a vibration absorber is the main rotor head. There are no C of G problems and the absorber is virtually 'at source'. The most popular form of rotor head vibration absorber is the bifilar but whilst such devices are effective they have disadvantage in that a large proportion of installed weight is ineffective. Furthermore operation relies on sliding or rolling of metal surfaces which is particularly unacceptable where maintainability and reliability are paramount considerations. What is required is a device with no maintenance requirement.

Westland have tackled the problem with a spring mass absorber possessing polar symmetry, the spring arms of which consist of spirally-wrapped G.F.R.P. arms. The major factors in the design were installed weight, absorber bandwidth, spring strength, extraneous motions and load limits set by existing fatigue data. The absorber has undergone an extensive flight test evaluation on a Lynx and has behaved well through the flight envelope. Significant vibration reduction has been obtained throughout the airframe (and on external stores) and spring life should be such that the absorber will be a 'fit and forget' item.

Plans are well advanced to productionise the device.

## 1. INTRODUCTION

It is an unfortunate fact of life that parasitic devices are still, in general, required to control helicopter vibration in spite of advances made in rotor system and fuselage design. The choice of the controlling mechanism depends upon the details of the problems at hand and upon the degree of control built into the initial design.

Apart from the fundamental areas of design such as rotor system and fuselage the most obvious ways to control vibration are by isolation or absorption.

It may well be that when all things are considered that the total effect in terms of vibration control is similar regardless of what system is chosen; the major decision is whether vibration control is built in to existing structural design (isolation) or whether some limited compromise is made at the outset in that fixing places for absorbers are added to be used as and when required.

This paper is concerned with the design and evaluation of a vibration absorber which can be mounted at the main rotor.

## 2. BASIS OF DESIGN

An especially attractive place to fit a vibration absorber is at the main rotor head. Two major advantages are proximity to source and minimal C of G effect. The most interesting choice is whether it should be self-tuning or fixed frequency. The use of self-tuning centrifugal types of absorbers such as the bifilar is well established. More recent devices cope with both  $(n + 1)$  and  $(n - 1)$  rotating co-ordinate vibrations although this increases the maintenance requirement which appears in any case to be a disadvantage.

Westland first looked at a fixed-frequency absorber as a means of overcoming any potential reliability and maintenance problems. This was for use in Lynx which has a particularly simple rotor system which requires little maintenance.

What was sought was a device that was relatively light, compact, no maintenance requirement and capable of dealing with both  $(n + 1)$  and  $(n - 1)$  vibrations.

The general case of a vibration absorber attached to a structure is shown in figure 1. The response at a point  $X_3$  is given by

$$X_3 = F.A_{13} + \left( \frac{F.A_{12}}{S_{12} + A_{12}} \right) A_{23}$$

Where  $F$  is the externally applied 'force' and  $x_3$  is the response at  $x$  due to the force at  $y$ . For the absorber to have any effect it is necessary for there to be finite receptances between the point of force application and absorber attachment and between absorber attachment and the point of interest.

The predominant 4R forces exciting the Lynx fuselage are pitch and roll moment excitations. Clearly, to have any effect it is necessary for these moments to induce in-plane movements which are in turn nullified by the absorber, which is simply an 'in plane' device.

It was assumed that the forces required to nullify these displacements would be around 1400 lbf and it was decided to design a device generating 20g, giving an absorbing mass of 70 lb. and a total spring stiffness of around 3500 lb/in to tune the absorber to around 22 Hz (4R on Lynx).

At first sight it was not clear on what basis the absorber tuning should be based. A comprehensive analysis of the general problem of a spring-mass absorber rotating with the rotor showed that the fixed-frequency tuning should indeed be  $n/\text{rev}$ . The analysis also showed that the motion of the absorber would be very complicated and the first attempt to deal with these motions, based upon the use of crude coil springs, whilst effective, did not meet the 'fit and forget' requirement so further investigations based upon wrapped springs was undertaken.

Figure 2 shows the motion to be catered for, in the rotating axes.

#### Overall Geometry

An envelope and primary structural concept was established within which the absorber was to be designed (Figure 3). Centre-line height was fixed by maximum permissible bending moments at the rotor head attachment. The aim was to clear the attachment using existing fatigue test data. Minimum height was fixed by maximum absorber excursions under heavy landing conditions whilst outer diameter was fixed by minimum wall thickness considerations.

#### Spring Design

A most important consideration in spring design, once the geometry is chosen, is weight and material. Relative weight can be estimated from the equation  $\omega \propto \rho E / \sigma^2$  where  $\rho$  is material density, E is Elastic Modulus and  $\sigma$  is allowable stress.

From a consideration of simple bending we find for the present application the following material weights:

Steel	59 lb.
Titanium	24 lb.
G.F.R.P. ('E' Glass)	8 lb.

and so E Glass was chosen as the best material.

A finite-element analysis of the bending stresses and stiffness of a spirally-wrapped spring taking the form  $\rho : a \phi$  was performed, and from this an initial sizing was carried out. At the same time methods of hub/spring attachment were being considered and that initially adopted is shown in figure 4,

together with the spring geometries required to give a stiffness of 1750 lb/inch per layer of springs and an unfactored bending stress of 17000 lb./square inch. It is seen that the spring arms are wrapped to give a continuous lay-up through the hub, this being a particularly attractive concept.

Spring manufacture is covered in a later section.

#### Preliminary Experiments and Refinement of Design

Initial experiments were designed to establish the natural frequencies of the absorber and its behaviour at maximum vibration amplitude. The device as originally conceived had the whole of the effective mass on the outer ring and in this condition it was found that whilst the in-plane natural frequencies were nearly equal and similar to that predicted, the natural frequencies in pitch/roll were very near 2R and to avoid the possibility of sub-harmonic excitation it was decided to re-distribute the mass so as to significantly lower pitch/roll inertia and therefore increase the relevant natural frequencies. This was done by creating a 'top cover' which was also used to introduce a positive snubbing arrangement. Further trials showed that whilst the frequencies were moved significantly the re-distributed mass caused the absorber to pitch as well as translate and so to bring the C of G back to the centre of action of the springs a bottom cover was devised.

These steps are shown in figure 5 together with the final arrangement which has been largely unchanged through subsequent development. It is noted that fine-tuning is achieved by the addition of weights to top and/or bottom of absorber, as required.

The absorber hub is mounted on a steel spigot 'A' which is, in turn, attached to the main rotor head via existing lifting-eye attachment holes. The absorber is located in the radial sense by spacer plates B whilst rotational location of the absorber relative to the spigot is by a small dowel.

At the top of the spigot is assembled a snubbing and captive arrangement 'C'. The idea here is that should catastrophic failure of the springs occur, (unlikely as there are 8 independent load paths from hub to absorber body), the main body of the absorber will not leave the rotor. Snubbing is arranged by impact of top and bottom covers on rubber sleeves. This would happen under only the most extreme conditions.

The absorber mass is distributed broadly as follows:

Outer ring D	38%
Top Cover E	21%
Bottom Cover F	21%
Tuning Weights G	15%
Effective mass of arms	4%

It is noted that there are 2 layers of springs, giving 8 independent load paths from absorber body to hub.

### 3. SPRING DEVELOPMENT

The initial spring design was very attractive from the point of view of hub fixing although the stress analyses undertaken were very very simple in nature and did not take into account the complicated stress fields within the hub.

In the event it was found that after limited endurance testing at the design amplitude of  $\pm 0.4$ " delamination of several springs at the hub centre occurred. Crack propagation was very slow and change in natural frequency minimal.

Because flight clearance of the springs was based upon the 'fail-safe' principle, i.e. if all the springs broke the absorber would not leave the rotor, it was decided to carry out initial flight evaluation with the delaminated springs. This was done successfully and initial flight experiments were concluded after basic tuning investigations had taken place.

In the meantime a more thorough analysis of hub attachment stresses had been undertaken and this indicated that the problems were originating within the hub centre itself causing failure in transverse shear. A re-designed centre, based upon the individual attachment of each arm was put in hand, the outcome of which is shown in figure 5. This has formed the basis of all further development testing and is a feature of the design shown in figure 5. Fatigue testing of hub attachments indicate infinite mean spring life. It is noted that the stiffness of the 'bolted' springs were somewhat higher than anticipated, resulting in an absorber with an effective mass of around 100 lb.

Figure 6 shows the tooling for the 'bolted' springs. Each spring is manufactured from pre-impregnated 0.25 mm 'E' glass. Strips of the material 2" wide are successively vacuum consolidated onto a slave lay-up tool and the finished preform is then placed into a press tool for consolidation and curing. The volume fraction finally arrived at is (nominally) 52 $\frac{1}{2}$ %. Small variations in volume fraction (and hence stiffness) can be catered for by small tuning weights attached to the top of the absorber.

### 4. FLIGHT TESTING

Exhaustive flight tests have been conducted on the Flexispring vibration absorber over the past year.

Examination of equation 1 would indicate that there is no obvious reason why a vibration absorber should work at all and it will be interesting to see the effect at a number of airframe stations. The other two unknowns were absorber bandwidth and total absorber excursion.

The basic tuning properties of an absorber are shown in figure 7. The location and number of resonant peaks in close proximity to antiresonance depends upon the proximity and number of normal modes in relation to the excitation frequency. Except for the particular case of a resonance, the absorber at frequencies around the excitation frequency will drive into an impedance that looks like a mass or a spring. The bandwidth is defined as

$$Z = \left( 1 + \frac{\bar{X}\mu}{(1-\bar{X})} \right)^{1/2}$$

where  $Z$  is the bandwidth,  $\bar{X}$  is displacement (absorber fitted)/displacement (no absorber) and  $\mu$  is the effective mass ratio  $m/m_0$  or spring ratio  $K/K_0$ .

Figure 8 shows, at one forward flight speed, the effect of varying rotor speed at a number of locations. It can be seen that optimum tuning is a compromise. In the case of the Lynx trials it was decided to optimise the effectiveness at maximum forward speed and figures 9, 10 and 11 show the effect of the absorber, at optimum tuning, at a number of stations.

It is noted that whilst in general the absorber is very effective, at one location there is no improvement at all. It is believed that the asymmetry of absorber behaviour is due primarily to superposition of vertical/pitch loads with lateral/roll loads.

Figure 12 shows absorber displacement (measured using a piezo-electric accelerometer mounted on the body of the absorber) as a function of forward speed and it is seen that the maximum design amplitude of  $\pm 0.4$ " was not exceeded during the trials in question. Interpretation of accelerometer response was, in itself, an interesting mathematical exercise.

Over 50 or 60 hours of flight testing, pilots have reported no adverse handling behaviour at all; on the contrary, reduced vibration in turns, max. power climbs etc. enhance the overall feel of the helicopter.

## 5. CONCLUSIONS

- (1) A fixed-frequency main rotor head vibration absorber based upon GFRP springs capable of absorbing around 2000 lb. shear force, has proved to be effective throughout the flight envelope of a Lynx helicopter.
- (2) A fixed-frequency absorber is most effective when used with a rotor system having minimal droop characteristics.

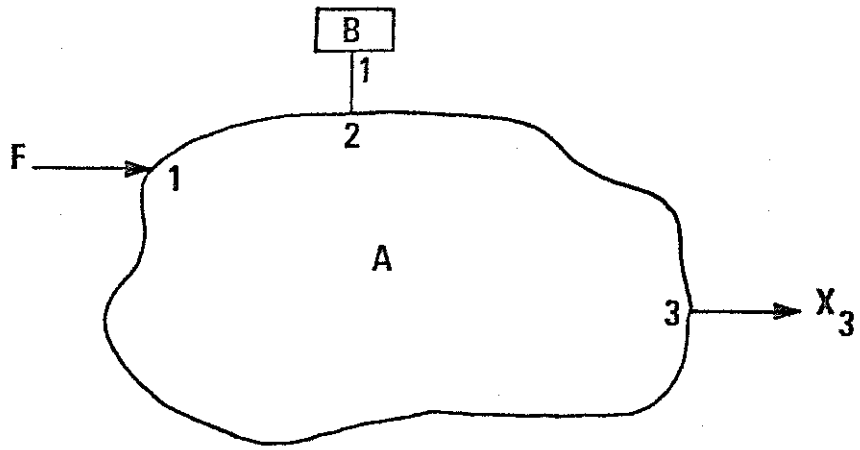

$$X_3 = FA_{13} + \left( -\frac{FA_{12}}{B_{11} + A_{22}} \right) A_{23}$$

$A_{ij}, B_{ij}$  = response at  $i$  due to force at  $j$

FIGURE 1

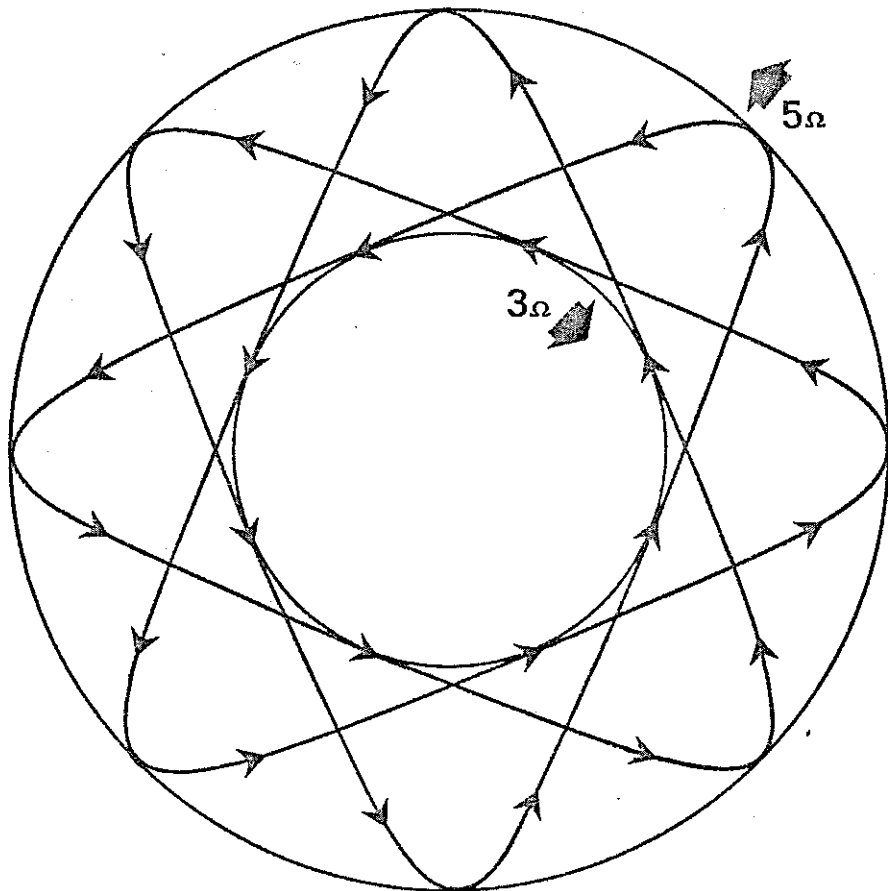

FIGURE 2



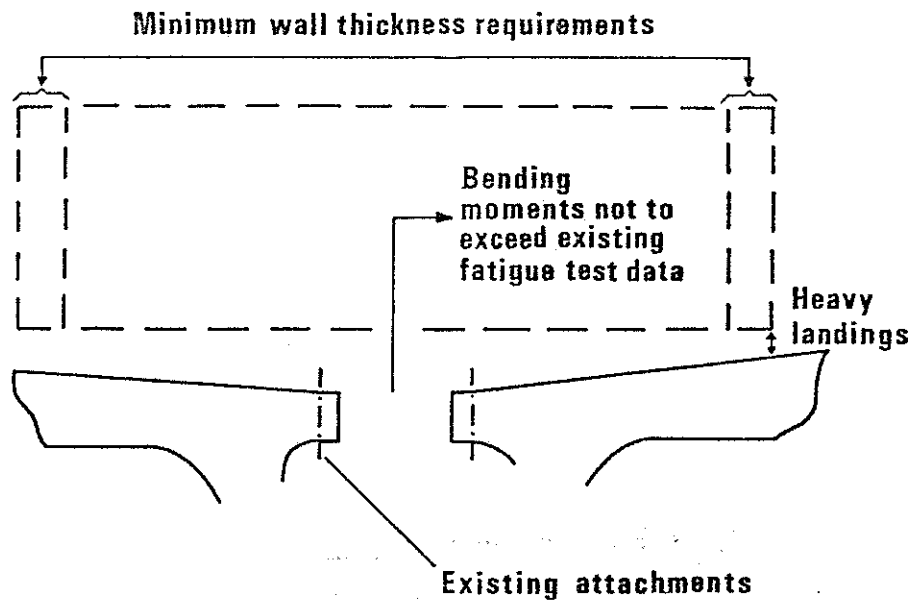

FIGURE 3

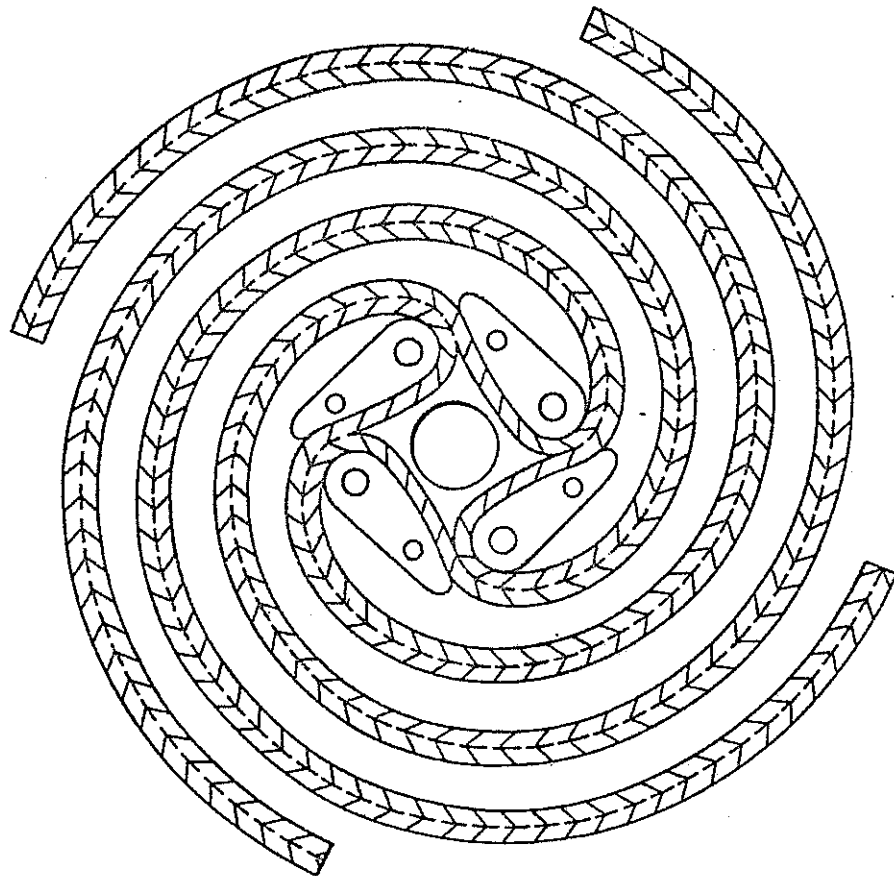

FIGURE 4

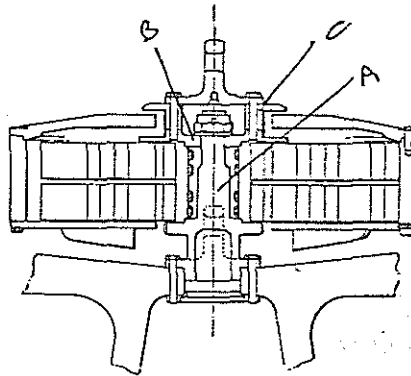
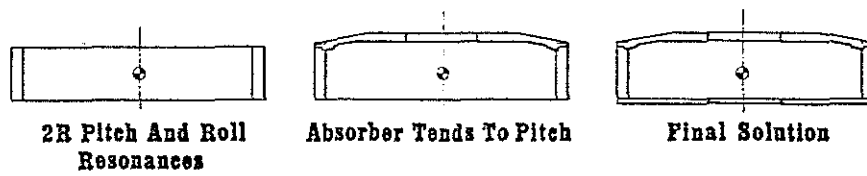

FIGURE 5

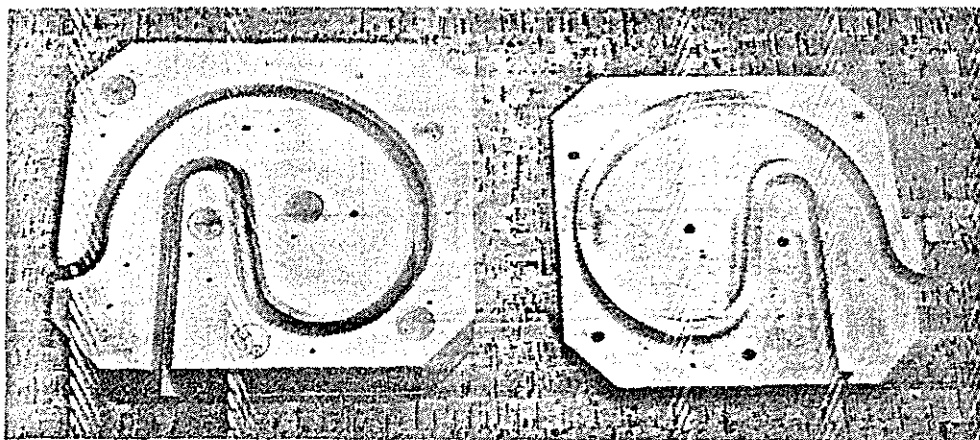
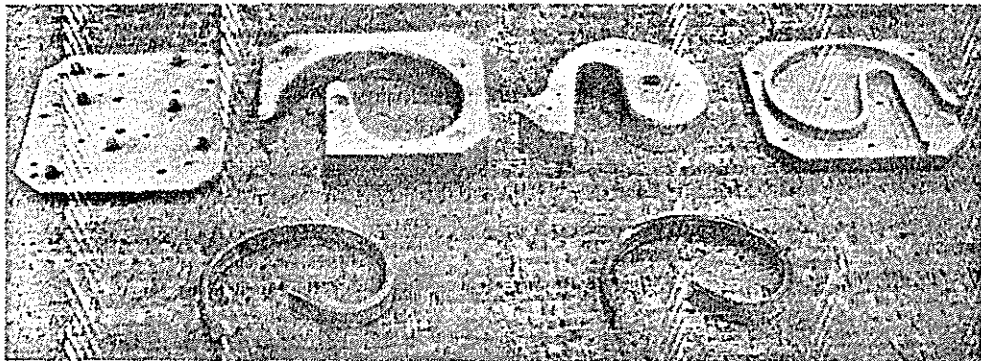

FIGURE 6

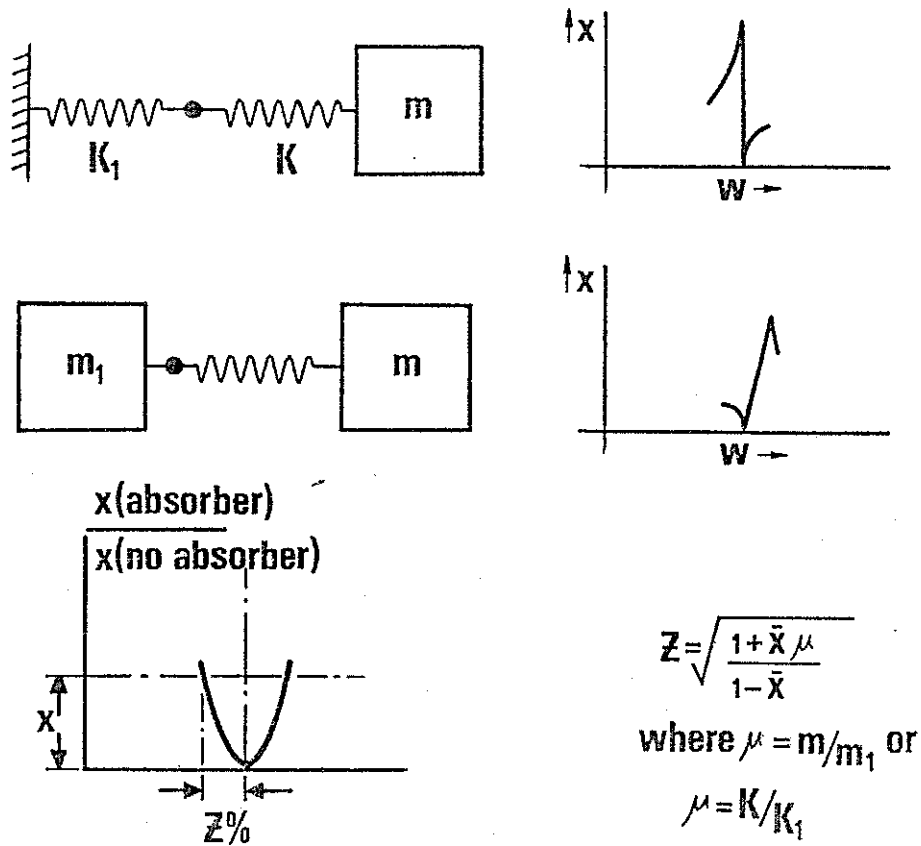

FIGURE 7

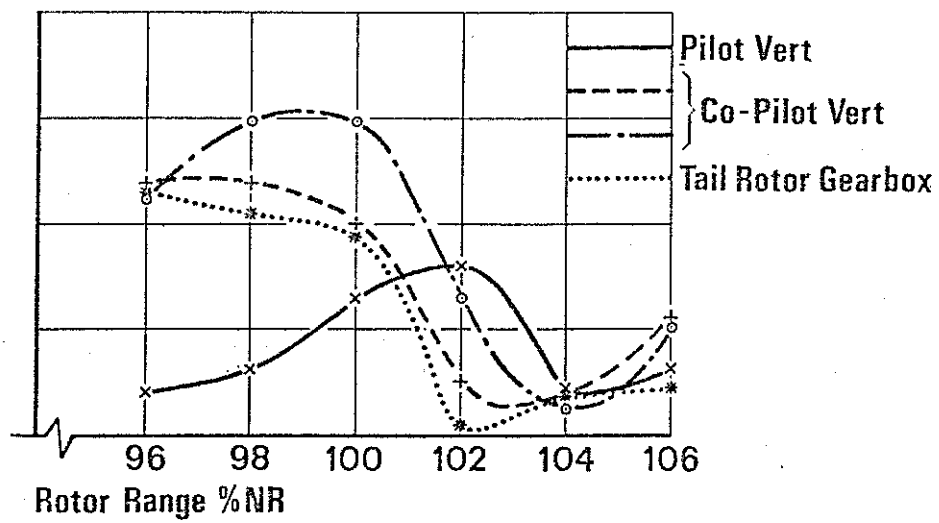

FIGURE 8

**EFFECT OF ABSORBER  
CO-PILOTS POSITION**

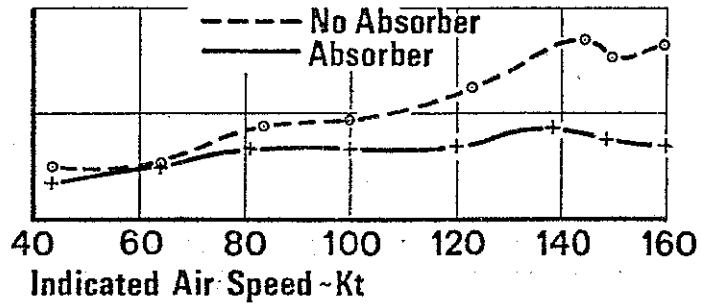

FIGURE 9

**EFFECT OF ABSORBER  
CONTROL FRAME LATERAL**

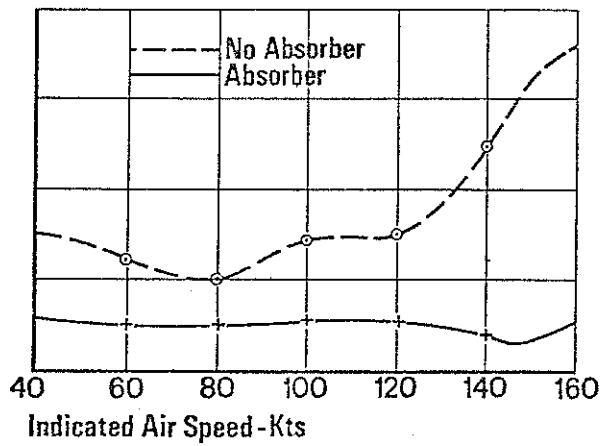
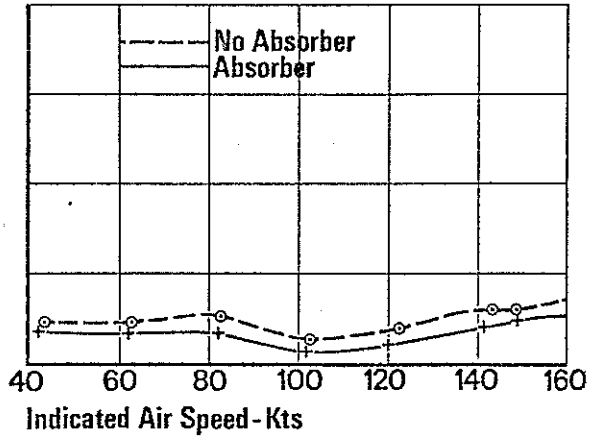

FIGURE 10

**EFFECT OF ABSORBER  
CABIN FLOOR LATERAL**



**FIGURE 11**

x-----x FLT. 118 (9750)  
 o-----o FLT. 120 (8150)

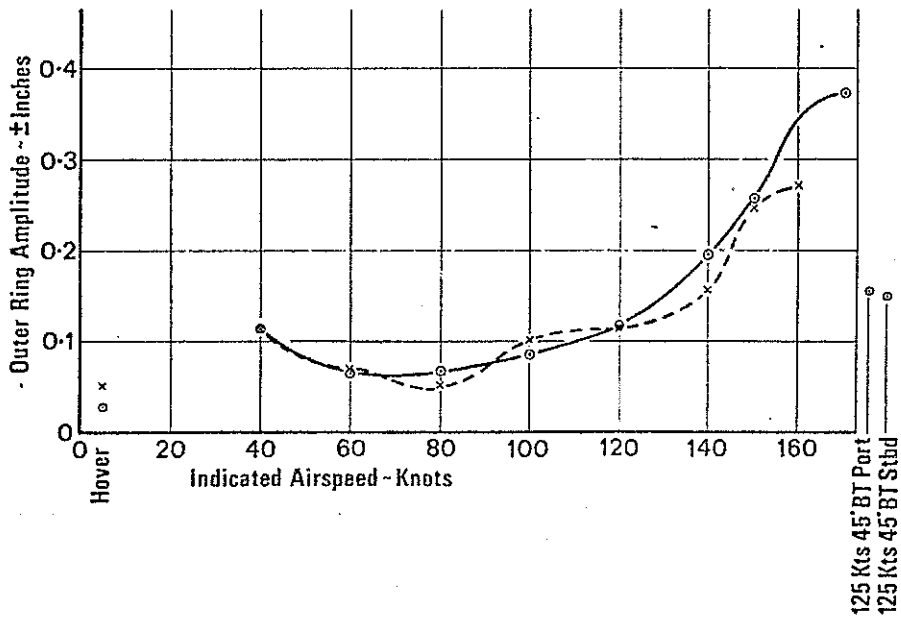

**FIGURE 12**