

TWELFTH EUROPEAN

ROTORCRAFT FORUM

(Garmisch-Partenkirchen - September 22/25 1986)

THE TILT-ROTOR AIRCRAFT :
A RESPONSE TO THE FUTURE ?
FROM EUROPEAN INTERROGATIONS
TO EUROFAR ACTIONS

(Paper already presented at Helicopter Manufacturer's Seminar for UK00A
ABERDEEN - September 1986)

J. ANDRES AEROSPATIALE *

H. HUBER M.B.B. **

J. RENAUD AEROSPATIALE ***

* Chief Engineer - Helicopter Division Programme Management

** Helicopter Division - Director of Preliminary Design

*** Helicopter Division Research Co-ordinator

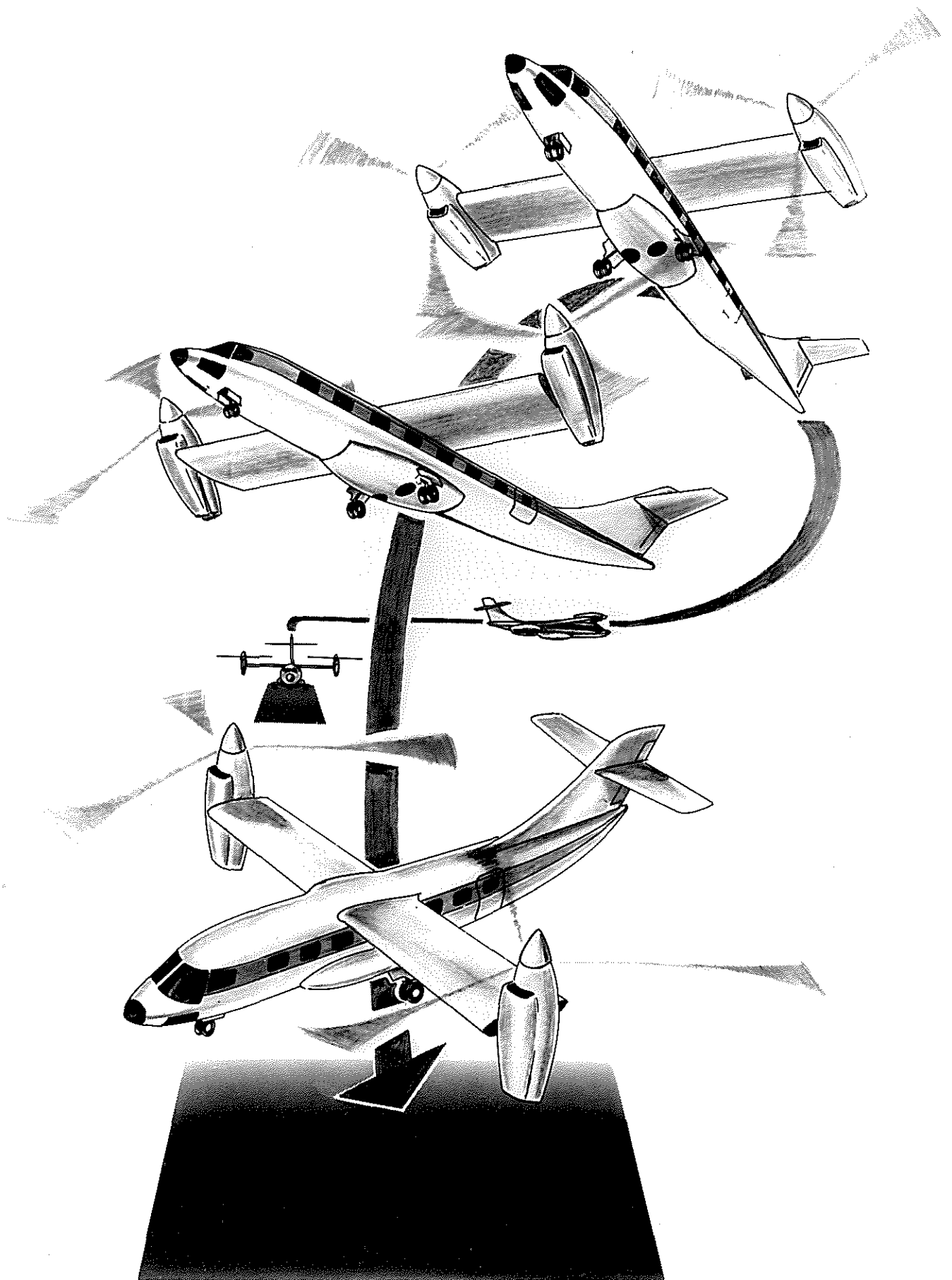

1 - THE HELICOPTER : A MAJOR AIRCRAFT

During the last five decades, emerging from its early ages, the helicopter became a major aircraft in the worldwide aeronautics. Solving the initial problems of piloting, handling qualities, vibrations, designers have patiently transformed it, after World War II, into an industrial product, completing its evolution by the utilization of lighter structures and powerful engines.

Achieving its maturity through the last development of computational aeronautics and practical technologies, taking advantage of an increasing level of knowledge in the field of new materials, aerodynamics, dynamics, avionics, the helicopter is now considered as a safe, reliable and efficient aircraft. In fact, it is at present time, one of the aeronautical tools for the civil commercial effectiveness and military readiness.

It is obvious that its large rotary wings and its original control system give it a unique flight capability in hover or at low speed, combining good power efficiency and handling qualities.

But, due to its fundamental architecture, high speeds are a serious limitation for this aircraft, with a decreasing practical interest of this formula for long-range missions.

2 - THE HELICOPTER LIMITATIONS

As the helicopter speed increases, the main rotor experiences a more and more non-axisymmetrical behaviour (fig. 1). At higher forward flight speeds, transonic problems with the occurrence of shock waves cause a limitation for the high-Mach operating advancing blade, whereas the retreating blade enters deeper stall conditions.

These natural limitations for highly three-dimensional interactional unsteady aerodynamics, cause a gradual loss of lift and propulsive forces, with an increased power requirement.

Furthermore, these alternate aerodynamic forces, strongly coupled with blades and hub dynamics, generate a forced response of this three-degree-of-freedom (flap, lead-lag and torsion) system. As we know, acting forces and moments for flap and lead-lag in rotational axis have frequencies depending on the number of blades and rotor rotational frequency. They act through the rotor head to give, in fixed axis, vertical motion to the cabin and stresses and moments to the shaft.

Whatever their origin, the general trend of these alternate loads is to increase with speed (fig. 2).

The problem of forced responses is a very important problem since :

- It induces, at high speeds, a significant cabin vibratory level, reducing the comfort and limiting the practical utilization of the helicopter.
- It introduces, in some vital components, alternate loads, which are the origin of fatigue phenomena defining the aircraft limitations and the service life of these components. Once again, higher speeds have an undesirable effect in a field which is one of the keys to safety (fig. 3).

Furthermore, tail rotors experience hard aerodynamic and dynamic problems.

Lastly, the high helicopter fuselage drag generates, at very high speeds, an important power need, with a dramatic fuel consumption.

All these physical boundaries give a clear explanation of the helicopter performance limitations, with, for example, a very smooth approach towards the "200 Knots barrier" (fig. 4).

3 - THE HELICOPTER EVOLUTION

Despite these hard limitations, designers have been utilizing, during the last decade, the most advanced scientific methodology and the highest technological issues, to imagine an expanded future for the helicopter (Ref. 1 to 7).

The latest remarkable milestone for this fruitful trends has been the recent speed record held by Westland Helicopter flying at 216 Knots.

The main ways to extend the helicopter limitations and to increase its operational efficiency could be :

- A more accurate main rotor design, using advanced airfoils, adapted twist, proper tips, selected blade dynamic properties, in order to achieve, through new computational methods, a better aerodynamic optimization and to reduce dynamic excitation and aeroacoustic sources.
- The utilization of new hubs combining lighter weight and smaller drag with reduced manufacturing and maintenance cost, through a reduction of the number of components, a modular design, an increased service life and an easier maintenance.
- The improvement of tail-rotors (Ref. 8) or the adoption of advanced anti-torque concepts, like the Fenestron Fan-in-Fin, which provides, in its last versions, high hover efficiency, with a good acoustic behaviour, needing less power at fast cruise speed, and providing a high level of safety for crew and ground personnel (Ref. 9).

- The design of new airframes, combining reduced weight, smaller drag and improved crashworthiness, through the adoption of new materials, and the utilization of advanced aerodynamic and structural computational methods and tests (Ref. 10 to 13).
- The improvement of transmissions, in terms of weight, service life, internal noise (Ref. 14).
- The improvement of filtering systems, leading, in the future, to the utilization of higher harmonic control systems (Ref. 15).
- The definition of advanced cockpits, with a pilot workload reduction and the definition of new flight mechanics laws through fly-by-wire systems, and more generally a system integration during the design (Ref. 16 and 17).
- Lastly, the utilization of advanced engines, with higher performance, reduced specific consumption, and improved maintenance through the use of modular design and monitoring systems.

4 - ADVANCED AIRCRAFT HISTORY : TOWARDS THE TILT ROTOR SELECTION

There is a gap between present conventional helicopters and fixed-wing aircraft, and it will remain, in spite of the extended capabilities of future helicopters. To fill this gap, considerable research efforts have been directed towards new V/STOL concepts during the last thirty years and, at least, fifty different kinds of research aircraft have been flown, mainly in U.S.A.

Most of them obtained bad evaluation conclusions, and many crashed.

To understand such poor results, it is advisable to classify these concepts according to (Ref. 18) :

- The type of lift generators (Hovering) :
 - . Rotors
 - . Free Propellers
 - . Ducted Fans
 - . Turbo Jets
- The methods to perform the transition :
 - . Separate propulsion
 - . Thrust deflection
 - . Thrust tilting
 - . Aircraft tilting

The type of problems raised by this advanced formula depends on their positions in this classification. But the most common reasons to explain so poor flight results were :

- The bad handling qualities in hover, during the transition and also near the ground, due to weak control, couplings, and bad behaviour prediction.
- Specific hovering problems depending on aircraft characteristics, related to high fuel consumption and poor efficiency, vibrations, noise, ground erosion and debris ingestion.
- The insufficiency of engines and transmissions reliability, as confirmed by several prototype crashes.

In fact, after so many years, if we except the "Harrier type aircraft", with a very specific military application, the only remaining solutions are rotary-wing aircraft :

- The Compound-Helicopter, despite few design problems, seems now out of date. In the future, its speed advantage over the conventional helicopter will gradually decrease, with important empty weight, and large fuel consumption at high speed.
- The ABC Concept, with two contro-rotative rotors, need also a propulsive auxiliary unit to really take advantage of the concept. Due to large drag, high consumption and vibratory level it exhibits a lowered interest.
- The X-WING, a "not yet born solution", since its highly complex command system, based on a blade blowing device, has not been flight tested. The in-flight rotor stoppage will need a lot of practical research and an important technological jump. In fact, if its speed capacities are very attractive, that will be done through a high fuel consumption and with a small payload. If its first flight tests are successful, its utilization could concern very limited military applications, in a far away future.

In fact, the Tilt-Rotor aircraft seems to be, today, the most attractive Advanced Formula.

5 - THE TILT-ROTOR : A WELL ESTABLISHED PROMISING CONCEPT

Following U.S. and European theoretical and ground tests evaluations, the U.S. XV15 Program has been one of the latest most fruitful prove-to-concept in the world aeronautical history (Ref. 19).

So, due to its suitable architecture, the tilt-rotor has yet demonstrated its ability to overcome the above mentioned problems.

- Its moderate disc loading provides honest hovering performances, not very far away from helicopter's (Fig. 5).
Furthermore, it does not experience specific problems in helicopter mode, in terms of vibration, ground erosion, debris ingestion. XV15 flight-tests proved a noise level comparable to quieter helicopters of the same class (Fig. 6) and acceptable for surrounding community (Fig. 7 derived from Ref. 20).
- A well-shaped fuselage, with a drag coefficient intermediate between clean helicopters and clean fixed-wing aircraft (Fig. 8 derived from Ref. 21), allows good cruise performances and takes advantage of the installed power for hover flight.
- Its "helicopter-type" cyclic control system is the key to its favourable handling qualities in helicopter mode, and provides good behaviour during the conversion (Fig. 9).
- At least, one of the most important feature of the tilt-rotor should be an appreciable cost-efficiency.
It is obvious, through available results and restricted European market surveys, that the quasi-totality of tilt-rotor potential missions time is performed in aircraft mode, for which the rotor aerodynamic behaviour is axi-symmetric (Fig. 10).
The resulting decrease in alternate loads induces a diminution of fatigue phenomena. Consequently, as well known for rotary-wing aircraft, spare and maintenance part of D.O.C. decreases as the service life increases (Fig. 11).

A rough evaluation of the 10 Tons class tilt-rotor and helicopter, using to-day technology, and based on conventional civil operation, has been performed (Fig. 12).

With the following main assumptions :

- Relative purchase cost (Tilt/Hel.) = 1.15
equal to U.S. evaluations for V.22 OSPREY (Ref. 22)
- Relative Service-life for major components (Tilt/Hel.) = 2

the Total relative D.O.C. (Tilt/Hel.) per hour is = 0.84

With a tilt-rotor speed twice that of the helicopter, the total relative D.O.C. per km is 0.42, and is consistent with evaluations for a fleet of 20 Tons class aircraft (Ref. 23).

So, twice the speed, twice the range, half the cost, that is the tilt-rotor challenge !

At least, always for the 10 T class aircraft, the results of the previous analysis show that, in spite of a tilt-rotor unit purchase cost estimated at 1.15 that of the helicopter, this cost is entirely recovered after about ten years (Fig. 13).

6 - THE TILT-ROTOR EMERGENCE : FROM EUROPEAN INTERROGATIONS TO EUROFAR ACTIONS

During the last ten years, much consideration was given to Advanced Aircraft, and more precisely to tilt-rotor by the European Rotary-Wing World. This fascinating challenge has been discussed, through companies prospectives, and in the framework of bilateral contacts, or larger organizations, including manufacturers and/or government agencies, dealing with research and/or industry, for military as well as for civil purposes.

The main common conclusions were the following :

- All European Helicopters Companies have sufficient technical level to solve the tilt-rotor problems. Furthermore, some of them have performed activities on this subject (see for example Ref. 24).
- With the development of V-22 Osprey, European Rotorcraft Industries will be soon facing a new situation, with the next delivery of the first Free-World military tilt-rotor (expected about 1992) probably followed by civil derivatives (expected about 1995).
- The tilt-rotor imminent emergence could eventually :
 - . Create new markets
 - . Modify the present helicopter world-wide market equilibrium
 - . Have a marginal interest for fixed-wing aircraft community.
- No European Company has, at the present time, the capability to launch important actions in this area.
So, cooperation is the only way to preserve the chance of European effectiveness in the field of Advanced Aircraft.

That will need the conjunction of largest European Companies efforts, and the support of their relevant National Authorities, eventually sustained by the various European organizations.

- There is no commercial competition between European companies in this area. Nevertheless, in any common action, these companies will have to take account of their own product policy and priorities, as well as European helicopters programs already launched or under discussions.
- Any important action will have to be subdued to the most accurate evaluation of the scientific, technological, industrial and commercial needs and risks.
- Any main industrial cooperation will have to be sustained by coordinate actions of the major National Research Agencies.

Taking account of this large concensus, Aerospatiale took the initiative, at the beginning of 1986, to call other companies to joint in Eurofar Program.

The following companies (Fig. 14) :

AERITALIA
AEROSPATIALE
AGUSTA
BRITISH AEROSPACE
CASA
MBB
WESTLAND

who are among the most advanced aeronautical firms from (Fig. 15) :

FEDERAL REPUBLIC OF GERMANY
FRANCE
ITALY
SPAIN
UNITED KINGDOM

with the possible assistance of European Companies and Agencies (Fig. 16) decided to joint the EUROFAR Program (European Future Advanced Rotorcraft).

Eurofar, which program will be briefly described in following sections, is :

- An opportunity for the integration of European manufacturers in the future main scientific trends.
- A project to effectively start up a program intended to complement conventional helicopters by the end of the century.

It has been envisaged as a new coherent transportation system, offering a very wide field of application, and composed of the following sub-elements :

- The vehicle, which will be a tilt-rotor aircraft.
- The sub-elements besides aircraft :
 - . infrastructures
 - . Air traffic control
 - . Certification and regulation

The analysis process from the aircraft concept to the industrial product could be achieved according to the diagram shown (Fig. 17).

It will also be necessary to evaluate both civil and military transport systems and relevant commonality (Fig. 18).

The "mirror-type" organization to be set-up will be constituted of :

- The manufacturers, assisted by Research Agencies, and dealing with the vehicle.
- The concerned Government Agencies, having in charge the sub-elements beside aircraft (with strong well defined relations between the two above groups).

The main operational goals assigned to the vehicle are :

- Operational costs reduction
- Safety improvement
- Speed and range increase
- Piloting and operations simplification
- Operational limits extension
- Air traffic insertion and downtown penetration capacity

It has been decided that a Preliminary Phase was necessary to :

- Perform a market study and choose a segment
- Perform a general definition of the demonstrator
- Identify the foreseeable technical problems and pre-study the critical points
- Carry out a detailed development program and cost evaluation
- Set up the industrial organization

As this Preliminary Phase fulfils the main goals of Eureka Charter :

- Improvement of European productivity and competitiveness in advanced technology fields offering a world potential market.
- Cooperation reinforcement between companies and research organizations.

it has been decided to submit this preliminary phase to the agreement of the relevant Eureka authorities and to ask for the corresponding support (Fig. 19), according to the following schedule (Fig. 20).

7 - AN EUROFAR WORKING-THEME : THE 10-TONS CLASS AIRCRAFT

To start the parametric studies and the first step of pre-project and technical evaluations, the 10-Tons class aircraft seems to be a good first working theme for EUROFAR, taking account of :

- Past European studies
- Expected potential missions
- Present state of international fleet, regarding mass and speed range (Fig. 21)

This segment will have, of course, to be confirmed by market study.

The first evaluations performed on this class of aircraft shows that such a tilt-rotor could satisfy the following basic mission :

- Transport of 19 passengers over 1000 km
- Average speed of 580 km/h
- "Category A" requirements satisfaction (Fig. 22)

From a structural standpoint, the tilt-rotor consists of an airplane fuselage with a fixed wing having a low aspect ratio and wing-tip mounted tilting rotors. The 3-view drawing (Fig. 23) shows the general features of such an aircraft top-winged, with tilting engines mounted at wing-tips with the rotors, and moderate disc loading, leading to a rotor diameter of 10 metres approximately. It will be noted that the geometrical characteristics of the wing (dihedral and sweep angles...) and rotor mounting (mast length...) are shown for information only.

A first estimated weight breakdown (Fig. 24) leads to :

- A basic version with a total weight of 10.200 kg, and a useful load of 4.010 kg, corresponding to a "empty-to-gross weight ratio" of 0.607.
- A maximum take-off weight of 13.000 kg, with a useful load of 6.800 kg.

It appears, obviously, that one of the most important goals is to maintain the empty weight as low as possible.

A possible commuter internal layout, compatible with external sizing previously shown (Fig. 23) could feature three front seat rows, with one aisle, providing, in addition, a compatibility with current military requirements (Fig. 25).

The main performances of such an aircraft are the following :

- A useful load/range diagram satisfying the basic mission requirements (Fig. 22) with vertical take-off, and showing the long range/low consumption characteristics of the tilt-rotor (Fig. 26).
The ultimate range can be extended to 6.000 km with a rolled take-off.
- The consumption per kilometer is halved if we take advantage of tilt-rotor high level flight capabilities (7500 m) as compared to ground level consumption (Fig. 27). At these altitudes, its consumption is 50 % that of the equivalent helicopter at ground level.

The high engine power imposed by "Category A" requirements confers very good performance in oblique climb flight (Fig. 28) as well as in hovering ceiling O.G.E. (3.400 m I.S.A. for the basic version) (Fig. 29).

The flight envelope covers that of a helicopter and of a twin-turboprop aircraft, while retaining good characteristics with one engine inoperative (Fig. 30).

8 - EUROFAR PROGRAM SCHEDULE

The above mentioned communication system, using a tilt-rotor as hereabove described, could be developed during an overall program divided into three phases and leading to the series production of an aircraft (Fig. 31).

- Phase 1 : Preliminary studies

This phase will allow gathering all scientific, technological, industrial, environmental and marketing elements necessary to decide the launching of further phases of the program.

- Phase 2 : Technological development and demonstration phase

This phase should allow demonstrating operational in-flight effectiveness of the tilt-rotor concept in the missions identified.

- Phase 3 : Industrial development

This phase should allow developing and certifying the production tilt-rotor aircraft.

The three years-long preliminary Phase 1 (Fig. 32), under final discussions, would be submitted, after companies definitive agreement, to the examination of Eureka's Authorities, for a final decision by European Minister Council in November 1986.

9 - CONCLUDING REMARKS

In spite of progress that will be induced by modern sciences and advanced technology for helicopter, the tilt-rotor aircraft is now well established as the most promising aircraft to fill the gap between conventional helicopter and fixed-wing aircraft.

Its unique operational capabilities offer the potential of an entirely new transportation system, with a wide scope of applications.

This fact must not be ignored by the European countries and, their active collaboration within the framework of Eurofar Program is a chance for Europe to advance the level of VTOL Aircraft Technology and to maintain European competitiveness.

REFERENCES

- [REF. 1] : M.V. LOWSON D.E.H. BALMFORD
(WESTLAND HELICOPTERS Ltd)
Future advanced technology rotorcraft
(American Institute of Aeronautics and Astronautics 1979)
- [REF. 2] : G. BEZIAC
(AEROSPATIALE)
Perspectives d'évolution technologique de l'hélicoptère
(l'Aéronautique et l'Astronautique 1979-4)
- [REF. 3] : R. MOUILLE
(AEROSPATIALE)
Future helicopters and new technologies
(37th AHS Forum Manufacturers' Panel - New-Orleans 1981)
- [REF. 4] : Richard B. LEWIS II
(AVRADCOM)
Future Helicopter Technology
(Vertiflite, March-April 1982)
- [REF. 5] : J.P. ROGERS, R.A. SHINN, R.C. SMITH
(U.S. Army Aviation Systems Command)
Impact of advanced technology on future helicopter preliminary
design
(Tenth European rotorcraft and powered lift aircraft forum -
The HAGUE 1984)
- [REF. 6] : K. SCHYMANIETZ, C. SCHICK
(M.B.B.)
Modern technologies for future light helicopters
(Eleventh European rotorcraft forum - LONDON 1985)
- [REF. 7] : R. MOUILLE
(AEROSPATIALE)
L'évolution prévisible des appareils à voilure tournante
(Académie de l'Air et de l'Espace - FRANCE 1986)
- [REF. 8] : G. BLACHERE, F. D'AMBRA
(AEROSPATIALE)
Tail rotors studies for satisfactory performance strength and
dynamic behaviour
(Seventh European rotorcraft and powered lift aircraft forum,
GARMISCH - PARTENKIRCHEN 1981)

REFERENCES (cont'd)

- [REF. 9] : R. MOUILLE - F. D'AMBRA
(AEROSPATIALE)
The "Fenestron" : A shrouded tail rotor concept for helicopters
(42th AHS Annual Forum - WASHINGTON 1986)
- [REF. 10] : M. TORRES
(AEROSPATIALE)
Development of composite material helicopter structure
(37th AHS Annual Forum, NEW-ORLEANS 1981)
- [REF. 11] : G. BEZIAC
(AEROSPATIALE)
Les applications des matériaux composites dans la constitution des hélicoptères
(l'Aéronautique et l'Astronautique N° 98 - 1983)
- [REF. 12] : F. GAMBARO - F. NATALIZIA
(AGUSTA)
Composite in the development of Agusta helicopters
(Tenth European rotorcraft and powered lift aircraft forum - THE HAGUE 1984)
- [REF. 13] : T.M.C.H. BARTLEY
(WESTLAND)
The advanced technology fuselage research programme
(Tenth European rotorcraft and powered lift aircraft forum - THE HAGUE 1984)
- [REF. 14] : DG. ASTRIDGE
(WESTLAND)
Health monitoring of helicopter gearboxes
(Eighth European rotorcraft and powered lift aircraft forum - AIX-EN-PROVENCE 1987)
- [REF. 15] : M. POLYCHRONIADIS - M. ACHACHE
(AEROSPATIALE)
Higher harmonic control : flight tests of an experimental system on the SA 349 research Gazelle
(42th AHS Annual Forum, WASHINGTON 1986)
- [REF. 16] : K. SCHYMANIETZ
(M.B.B.)
Impact of systems technology and integration on helicopter design
(Seventh European rotorcraft and powered lift aircraft forum, GARMISH- PARTENKIRCHEN 1981)

REFERENCES (cont'd)

- [REF. 17] : D. Von RETH
(M.B.B.)
Development of avionic systems for future helicopters
(39th AHS Annual Forum, ST LOUIS 1983)
- [REF. 18] : Ph. POISSON-QUINTON
(ONERA)
Introduction to V/STOL Aircraft concepts and categories
- [REF. 19] : Daniel C. DUGAN (NASA)
Ronald G. ERHART (BELL HELICOPTERS TEXTRON)
Laurel G. SCHROERS (U.S. ARMY)
The XV15 tilt-rotor research aircraft
(AVRADCOM Technical report 80A15)
- [REF. 20] : Ron REBER (BHTI)
Newt ROTHMAN (BVC)
A perspective on the commercial application of tilt rotor
(April 1986)
- [REF. 21] : J. GALLOT
(AEROSPATIALE)
Amélioration du bilan propulsif d'un hélicoptère
(17ème colloque d'Aérodynamique Appliquée - GRENOBLE 1980)
- [REF. 22] : BELL - BOEING
Tilt rotor team V22 OSPREY News Release
(Press - Conference Proceedings, 42th AHS Annual Forum,
WASHINGTON 1986)
- [REF. 23] : Standley MARTIN J.R.
(BELL HELICOPTER TEXTRON)
William B. PECK
(BOEING VERTOL COMPANY)
JVX Design update
(40th Annual Forum and technology display of the American
Helicopter Society - ARLINGTON, VIRGINIA 1984)
- [REF. 24] : G. BEZIAC
(AEROSPATIALE)
Composite blade for a five-meter diameter tilt-rotor
(4th European Rotorcraft and Powered Lift Aircraft Forum
STRESA 1978)

PROBLEM INHERENT IN HELICOPTER FORMULA: ASYMMETRICAL ROTOR OPERATION

aerospatiale

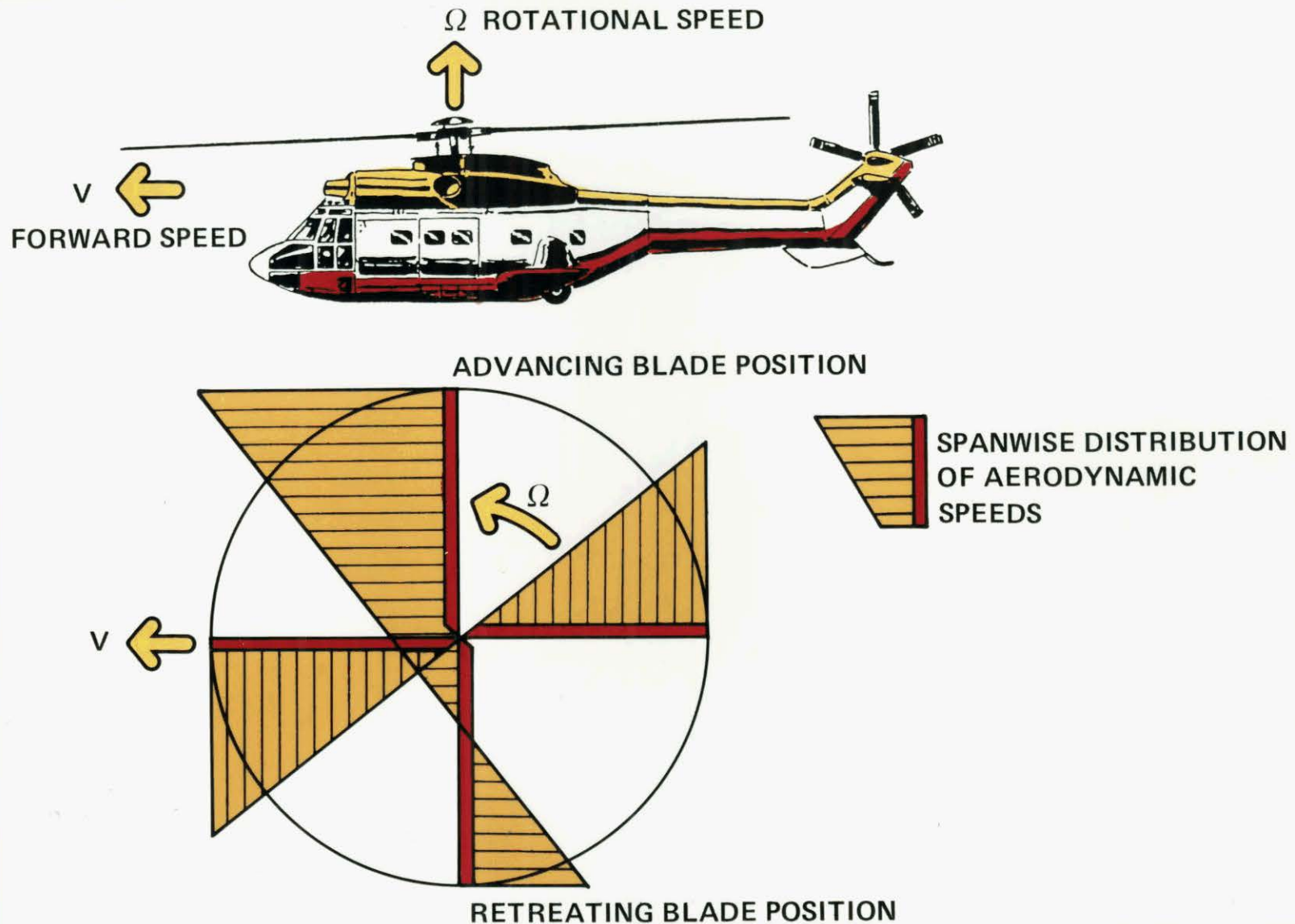

Fig. 1

**ALTERNATE LOADS ON ROTATING COMPONENTS IN 1/REV, 2/REV, 3/REV, ETC....
ALTERNATE LOADS ON FIXED COMPONENTS IN b/REV, 2b/REV, 3b/REV, ETC....**

aerospatiale

b = NUMBER OF BLADES

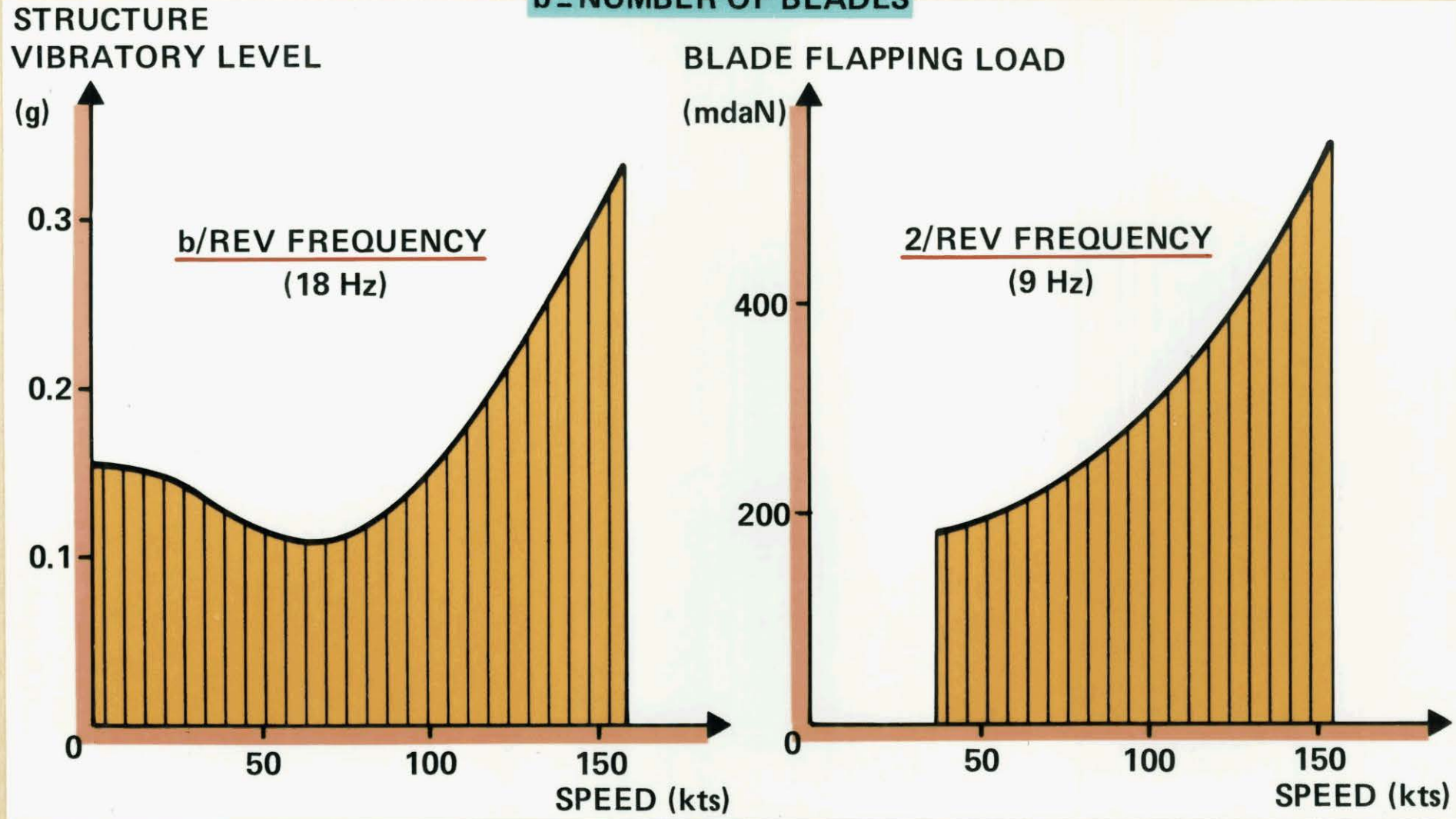

Fig. 2

NOTION OF SERVICE LIVES FOR VITAL COMPONENTS PERFORMANCES - SAFETY - COMFORT

aerospatiale

AS 332 AIRCRAFT – WEIGHT : 8350 kg

SA 342 AIRCRAFT – WEIGHT : 1900 kg

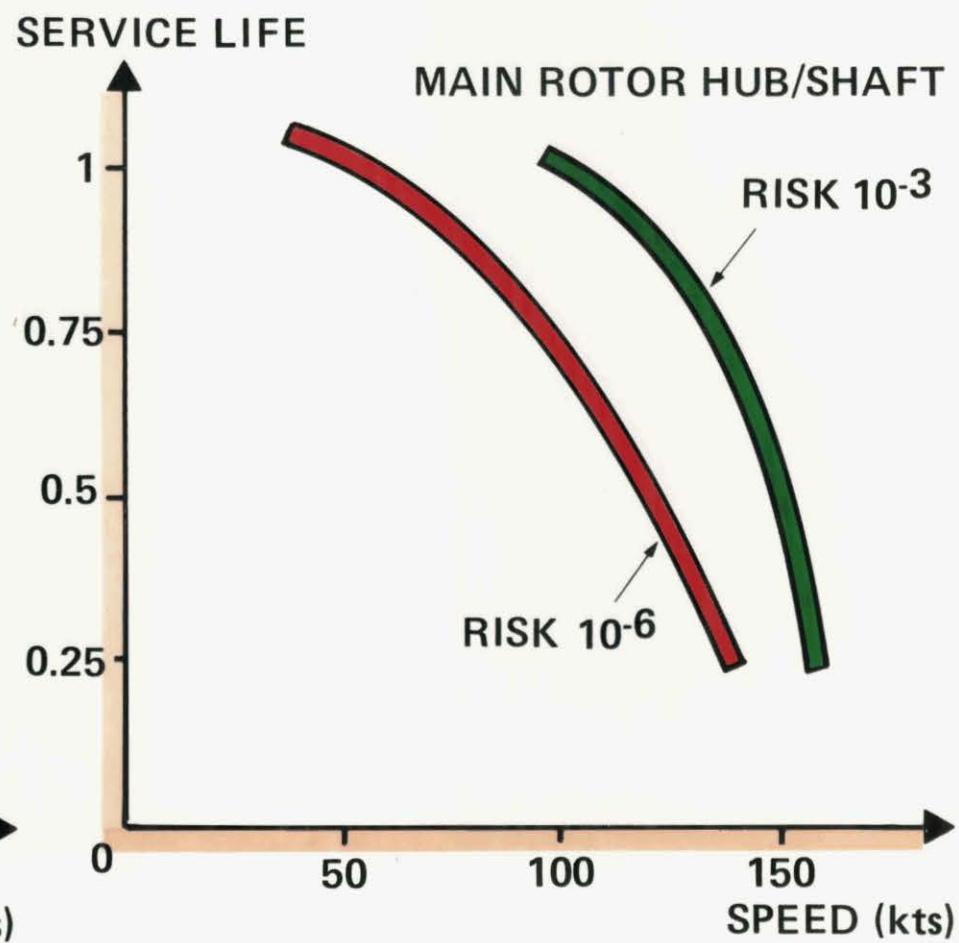
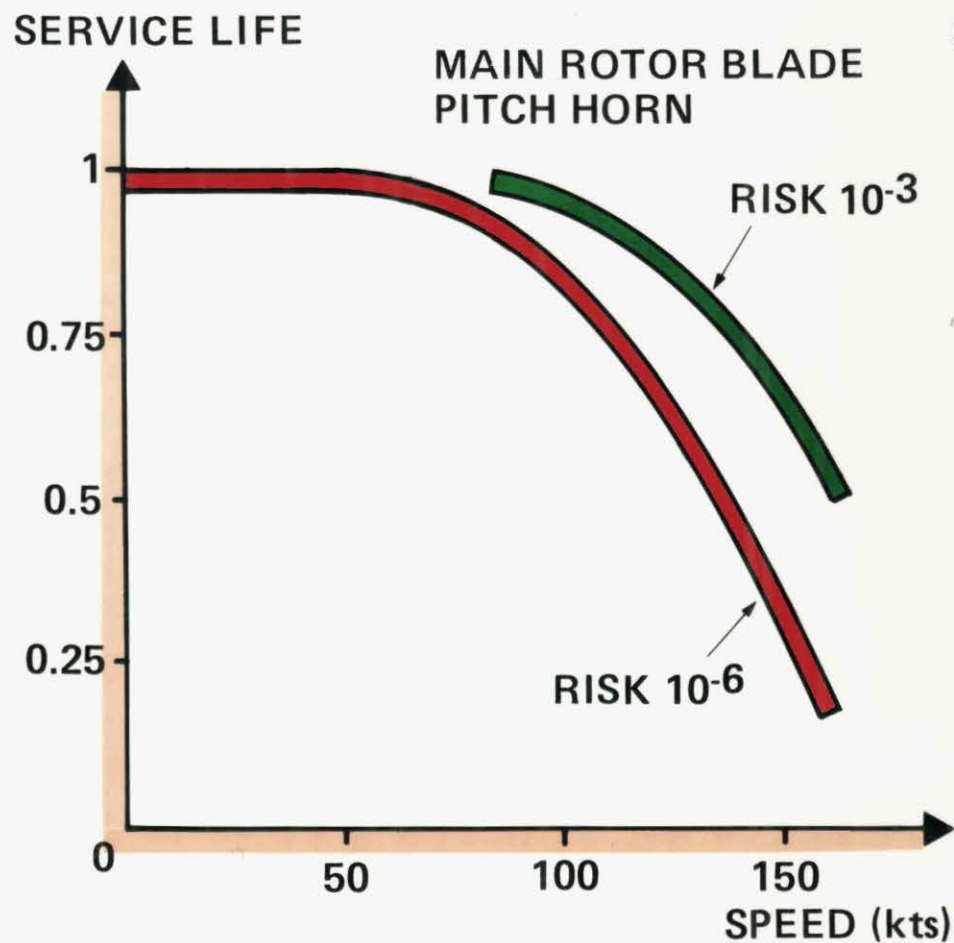

PERFORMANCE LIMITATION EVOLUTION OF SPEED RECORDS

aerospatiale

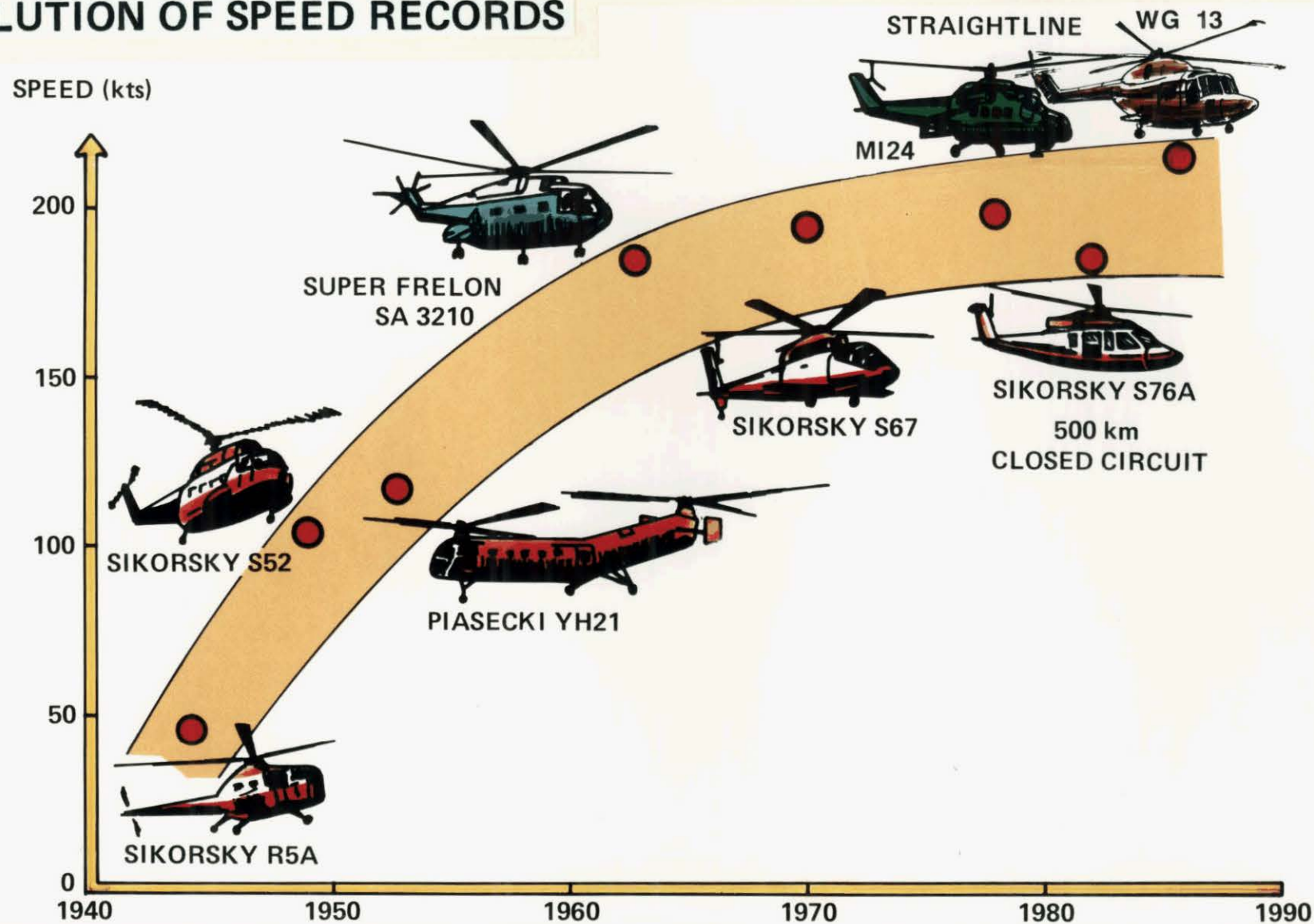

Fig. 4

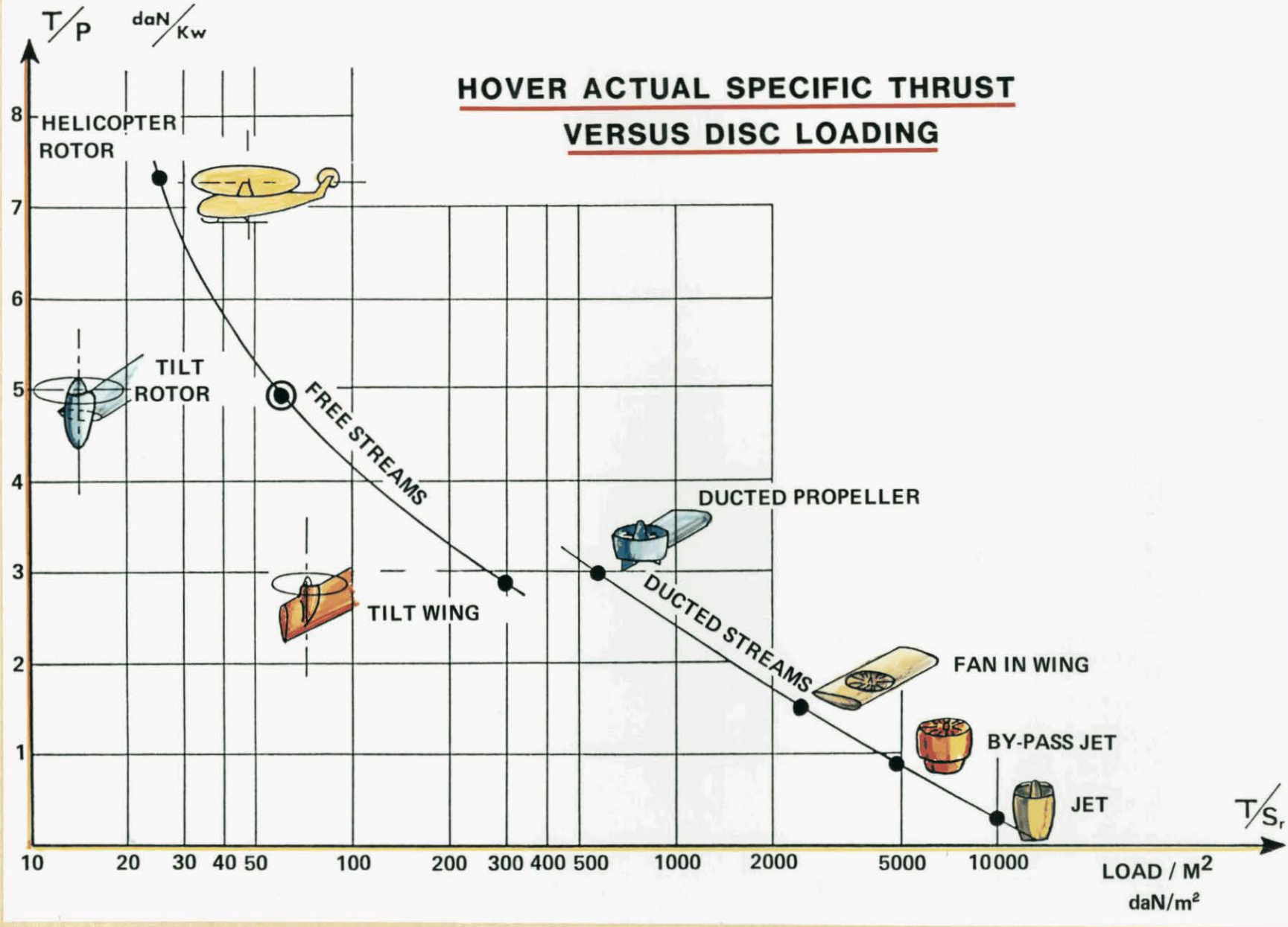

Fig. 5

ROTORCRAFT HOVER NOISE LEVELS

aerospatiale

500 ft SIDELINE PEAK HOVER
NOISE LEVEL. PNdB

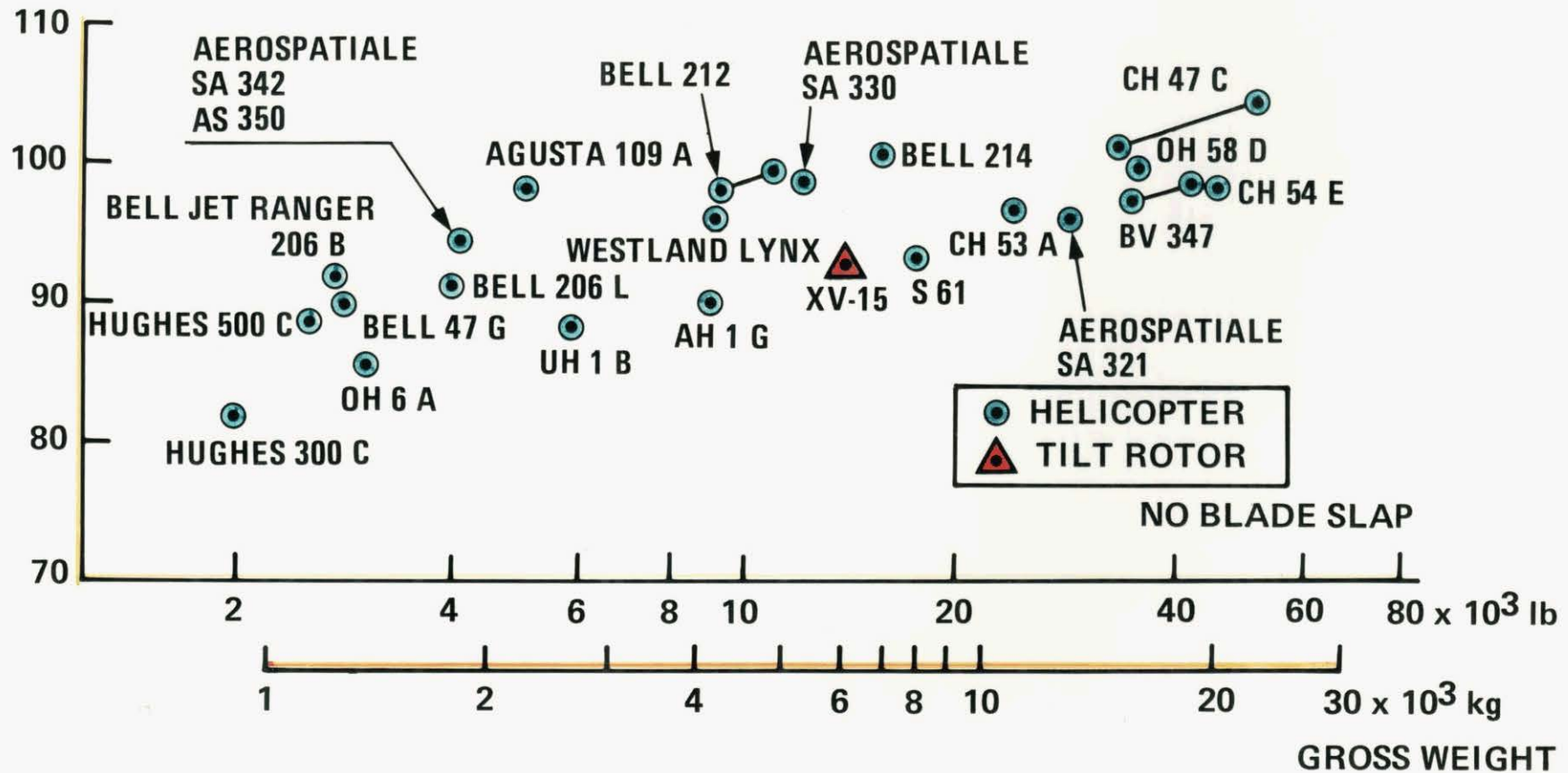

Fig. 6

TILT ROTOR NOISE LEVELS SAME AS SURROUNDING COMMUNITY

aerospatiale

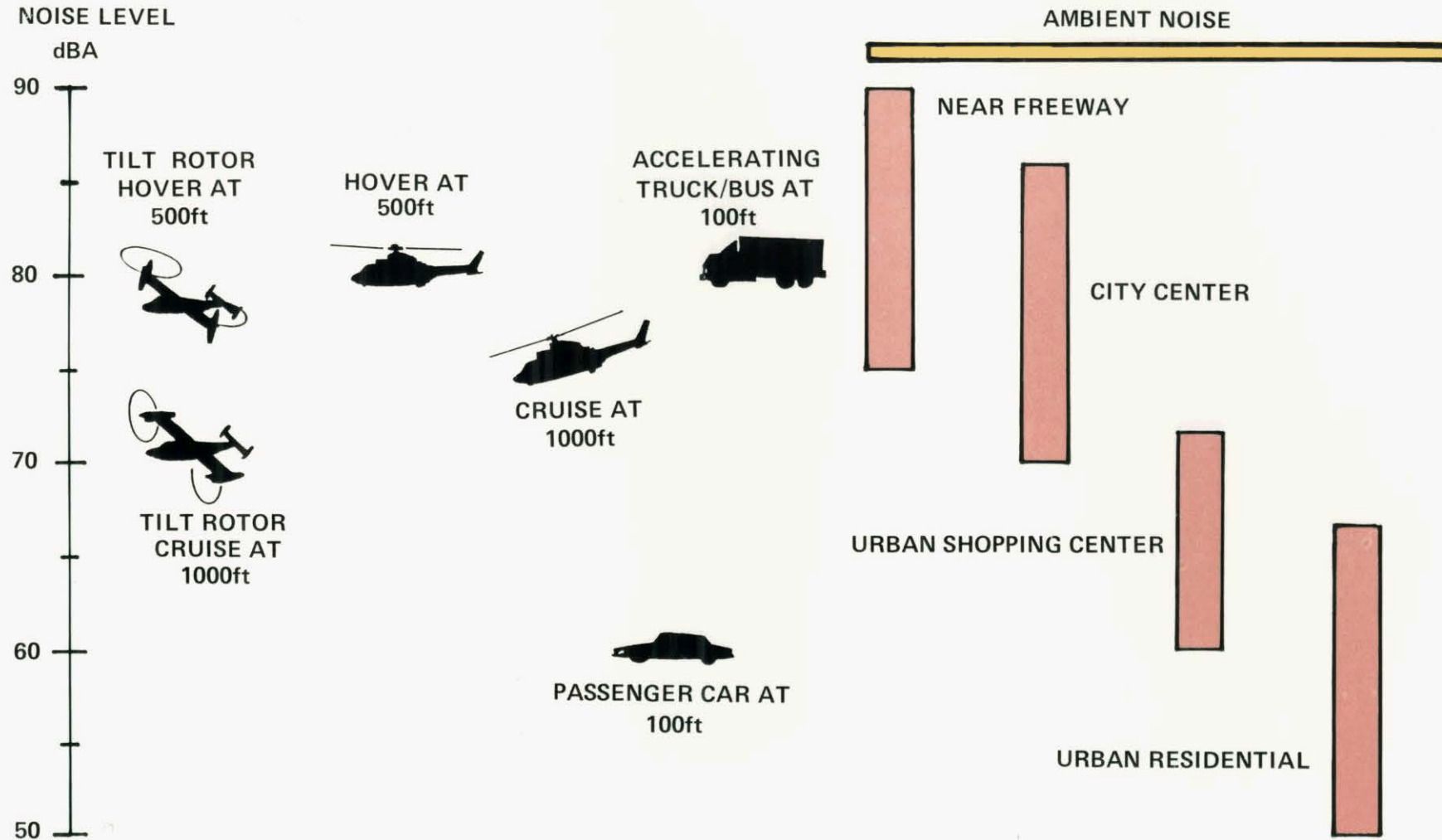

Fig. 7

AIRCRAFT PARASITE DRAG

aerospatale

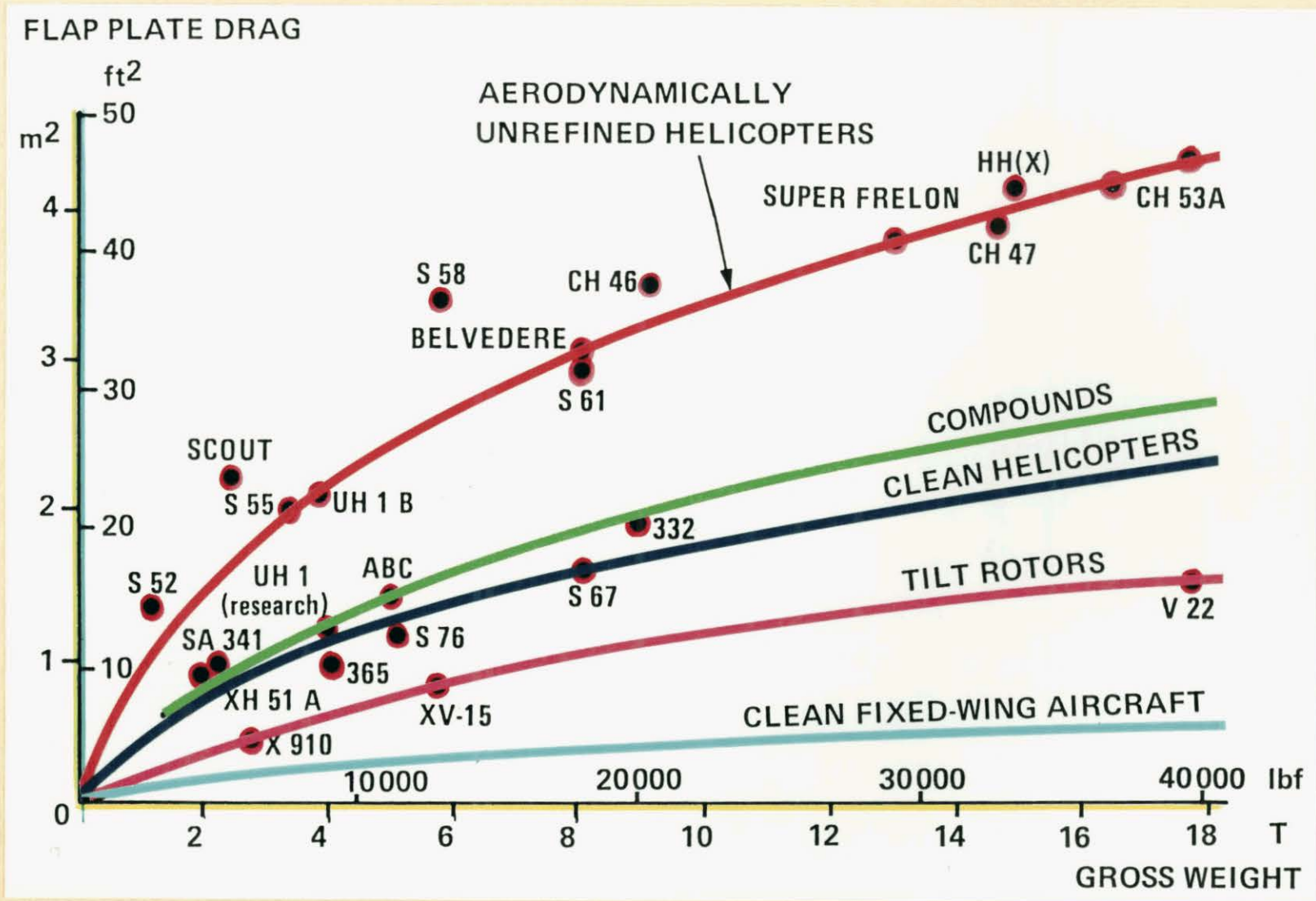
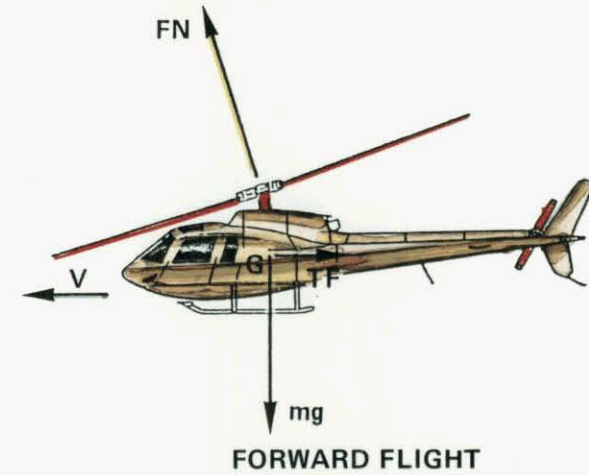

Fig. 8

OPERATING MODES

aerospatale

HELICOPTER



TILT-ROTOR AIRCRAFT

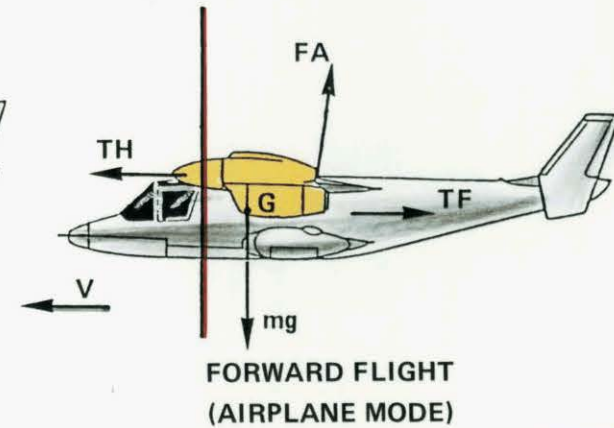
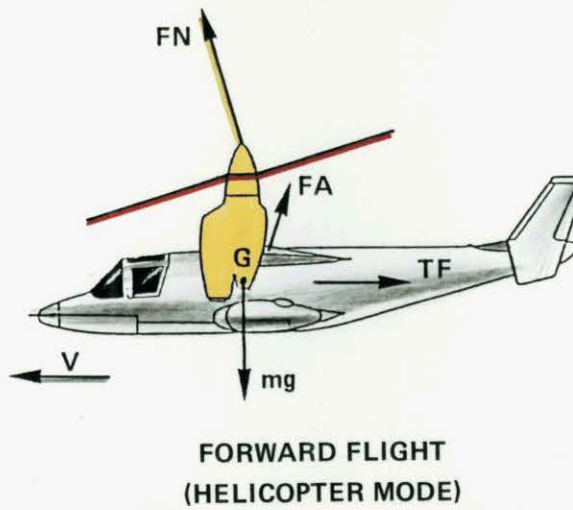
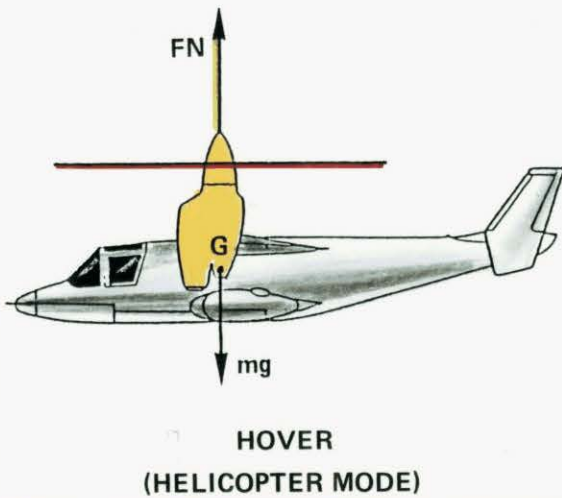

ADEQUATION OF TILT-ROTOR FORMULA TO FORWARD FLIGHT

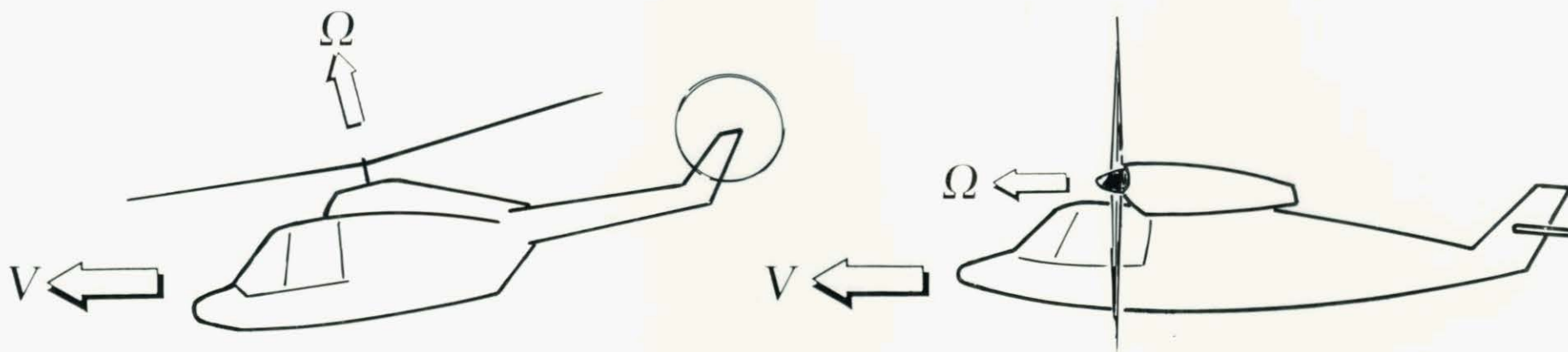

D.O.C. IS A FUNCTION OF SERVICE LIFE

aerospatiale

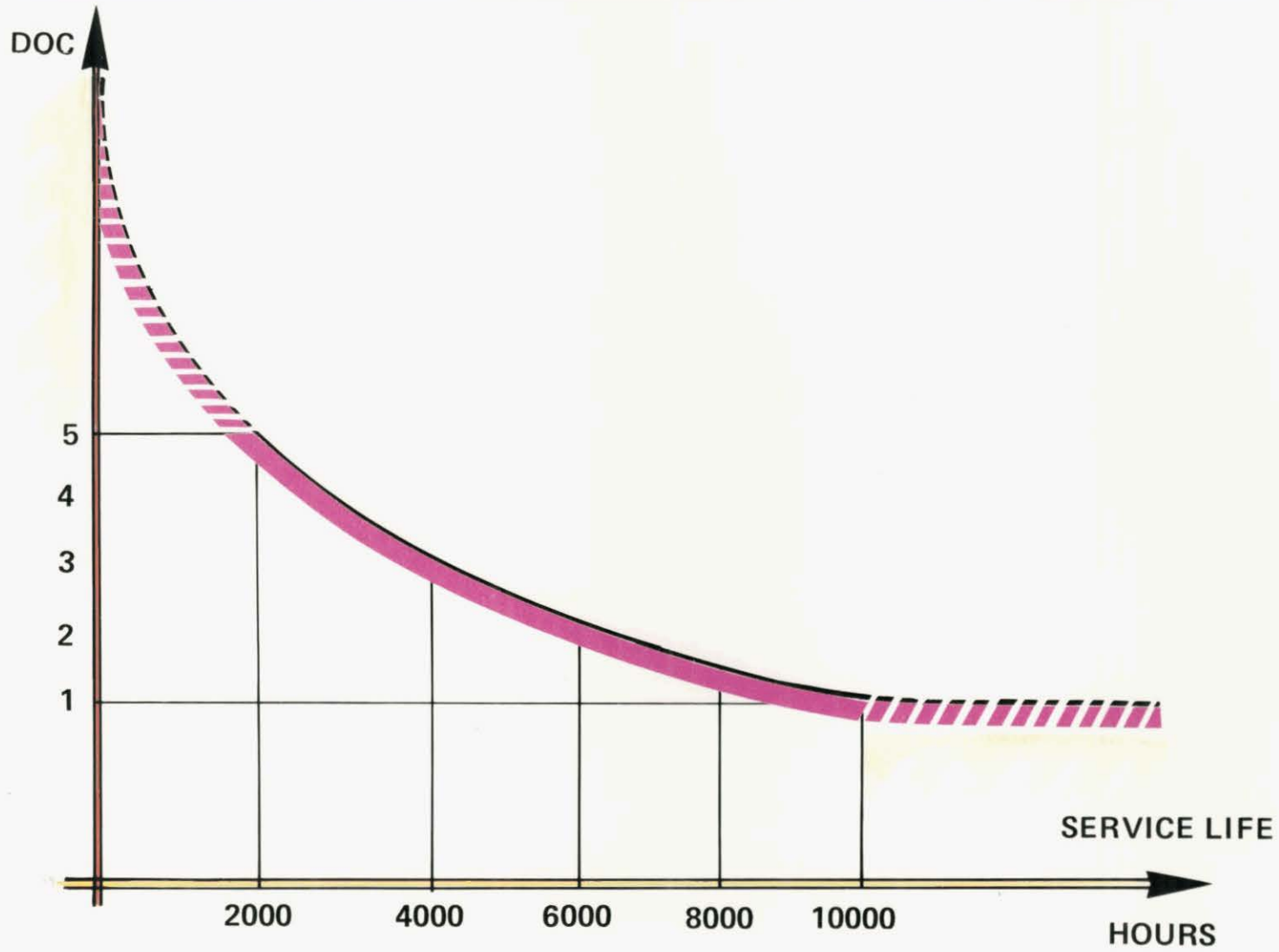
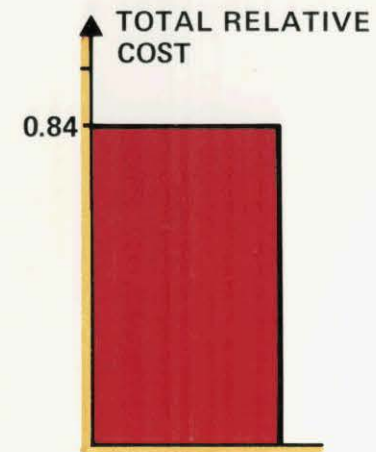
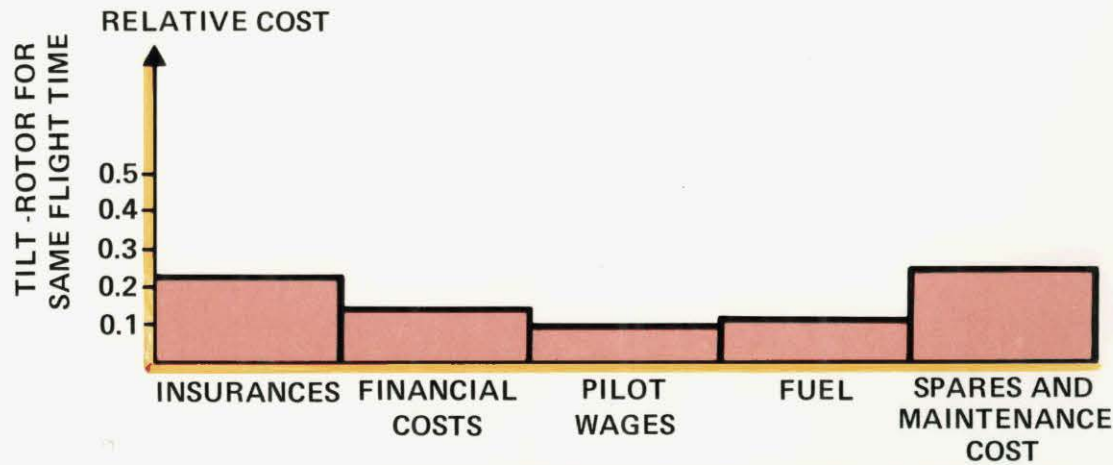
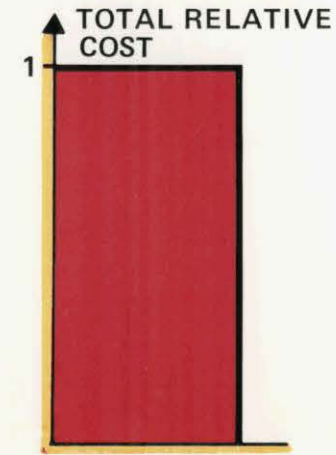
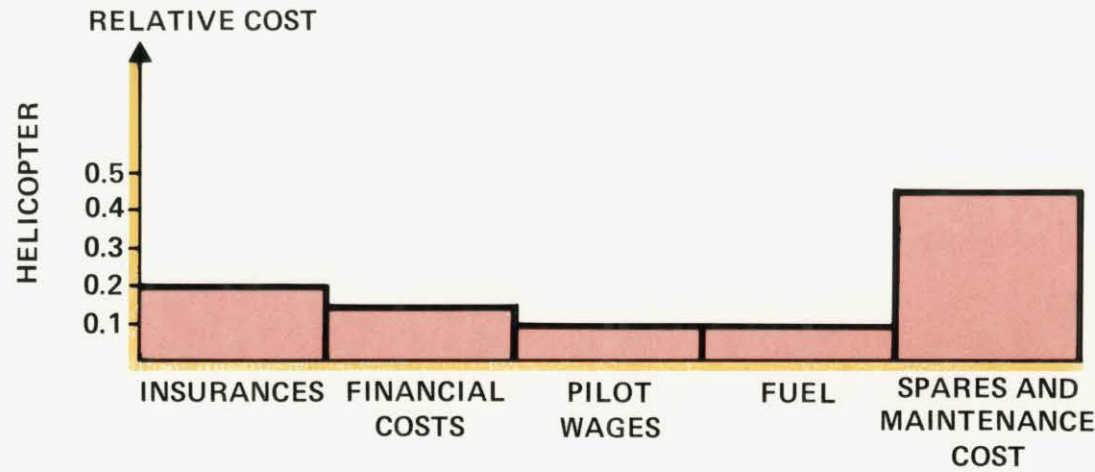

Fig. 11

DIRECT OPERATING COST EXCLUDING PURCHASE COST AMORTIZATION

aerospatiale



HENCE

TILT-ROTOR COST PER km = **0.42** HELICOPTER COST

DIRECT OPERATING COST

aerospatiale

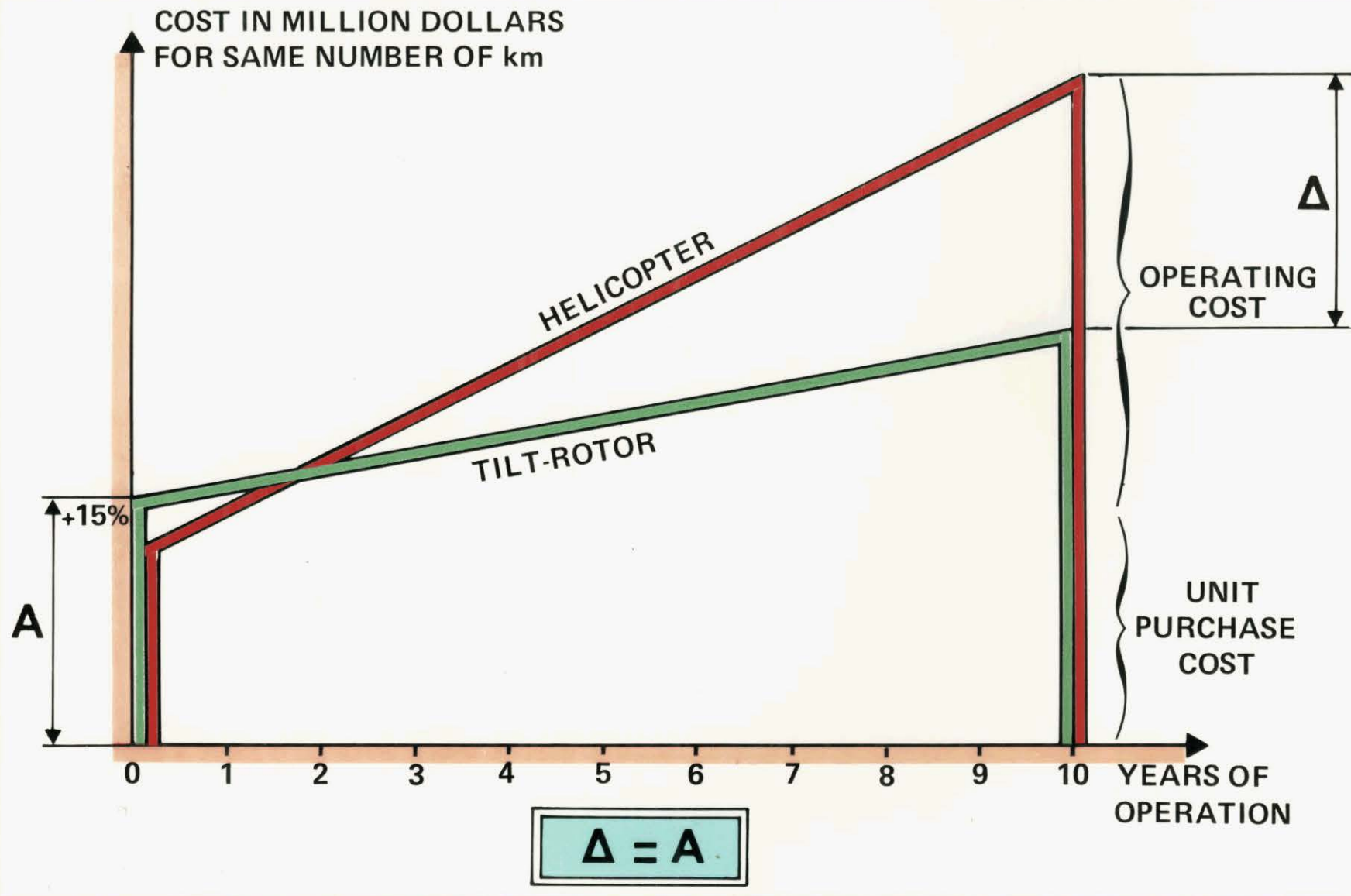
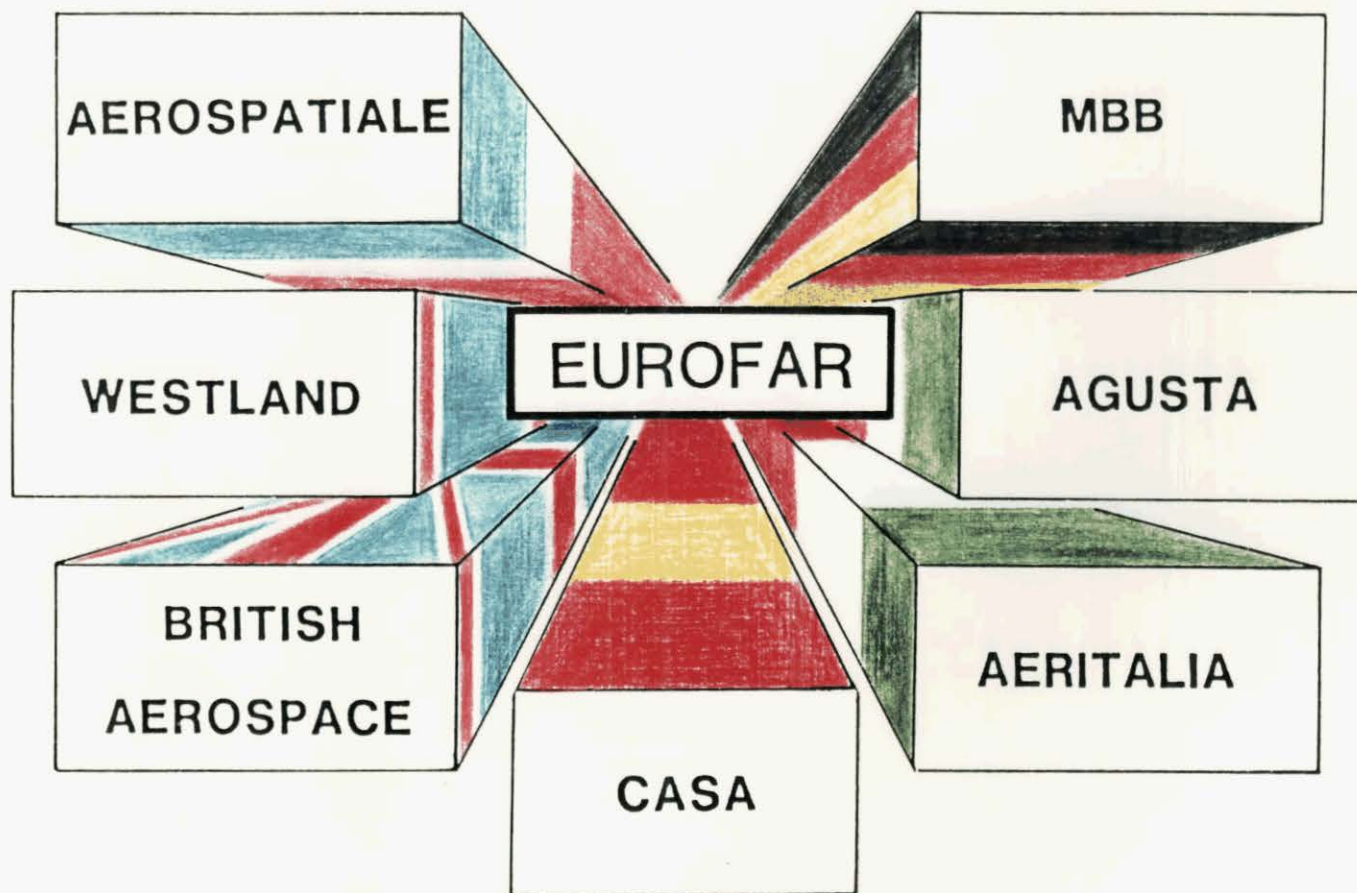

Fig. 13

PARTICIPATING COMPANIES



EUROPEAN CO-OPERATION

aerospatale

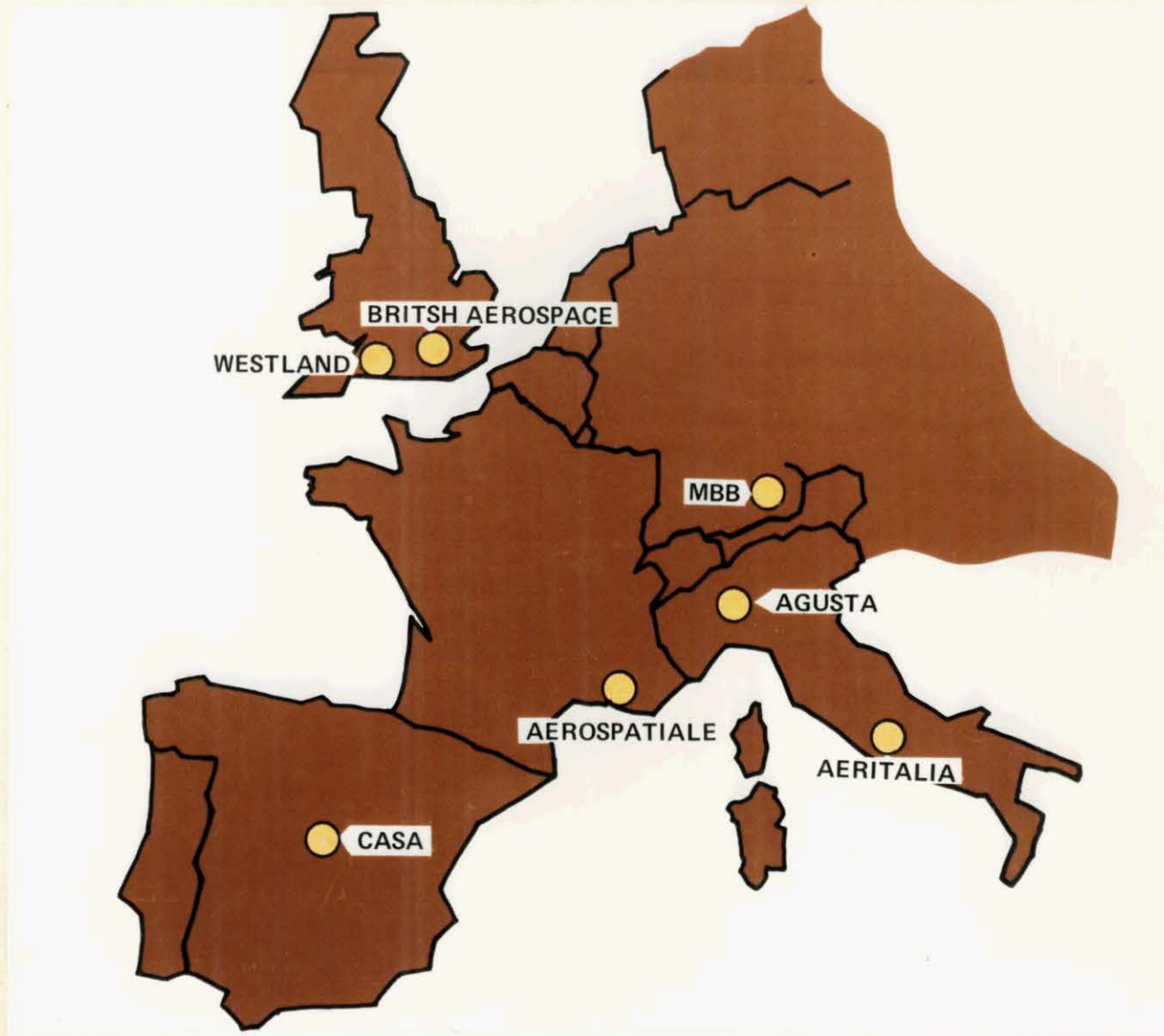

Fig. 15

EUROFAR

aerospatiale

POSSIBLE PARTICIPATION

- AIRCRAFT : AEROSPATIALE – AGUSTA – MBB – WHL
AERITALIA, BRITISH AEROSPACE, CASA...
- ENGINES : MTU – RR – TURBOMECA
- AVIONICS : «OPEN CHOICE»
- RESEARCH : DFVLR – ONERA – RAE – NLR

ANALYSIS GUIDE LINES (1)

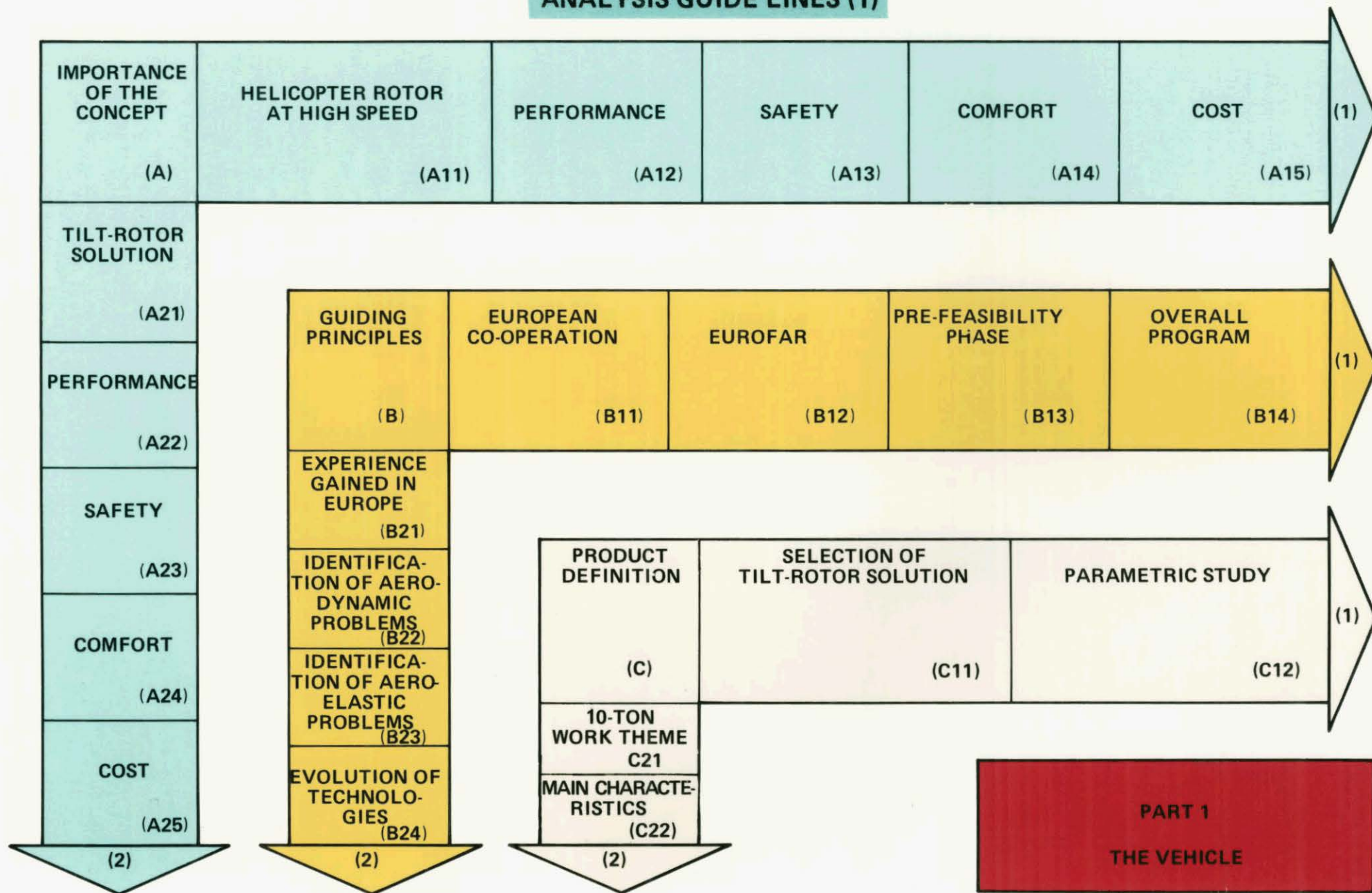

Fig. 17

ANALYSIS GUIDE LINES (2)

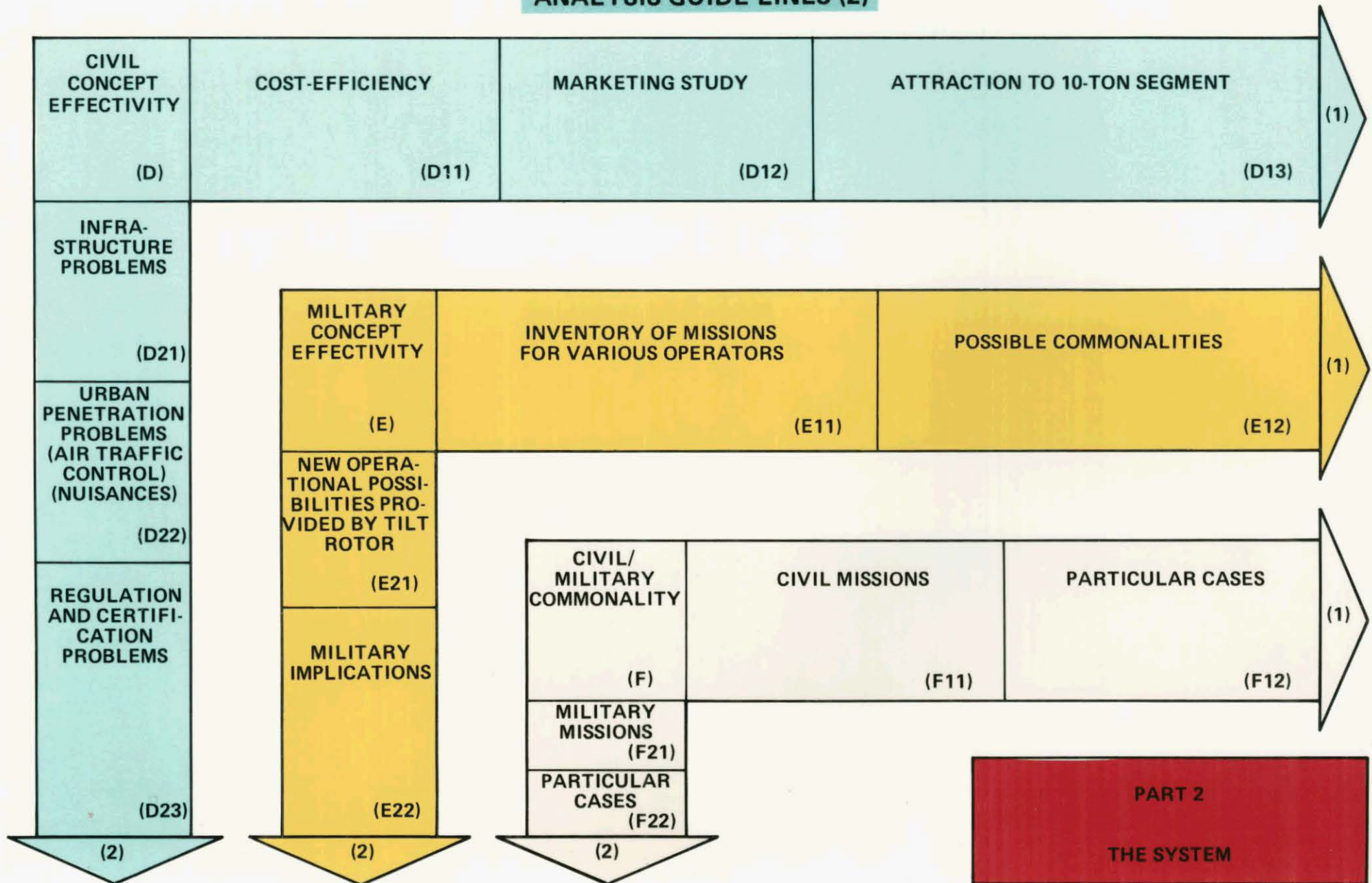

Fig. 18

EUROFAR

(European Future Advanced Rotorcraft)

MAIN PROPOSAL

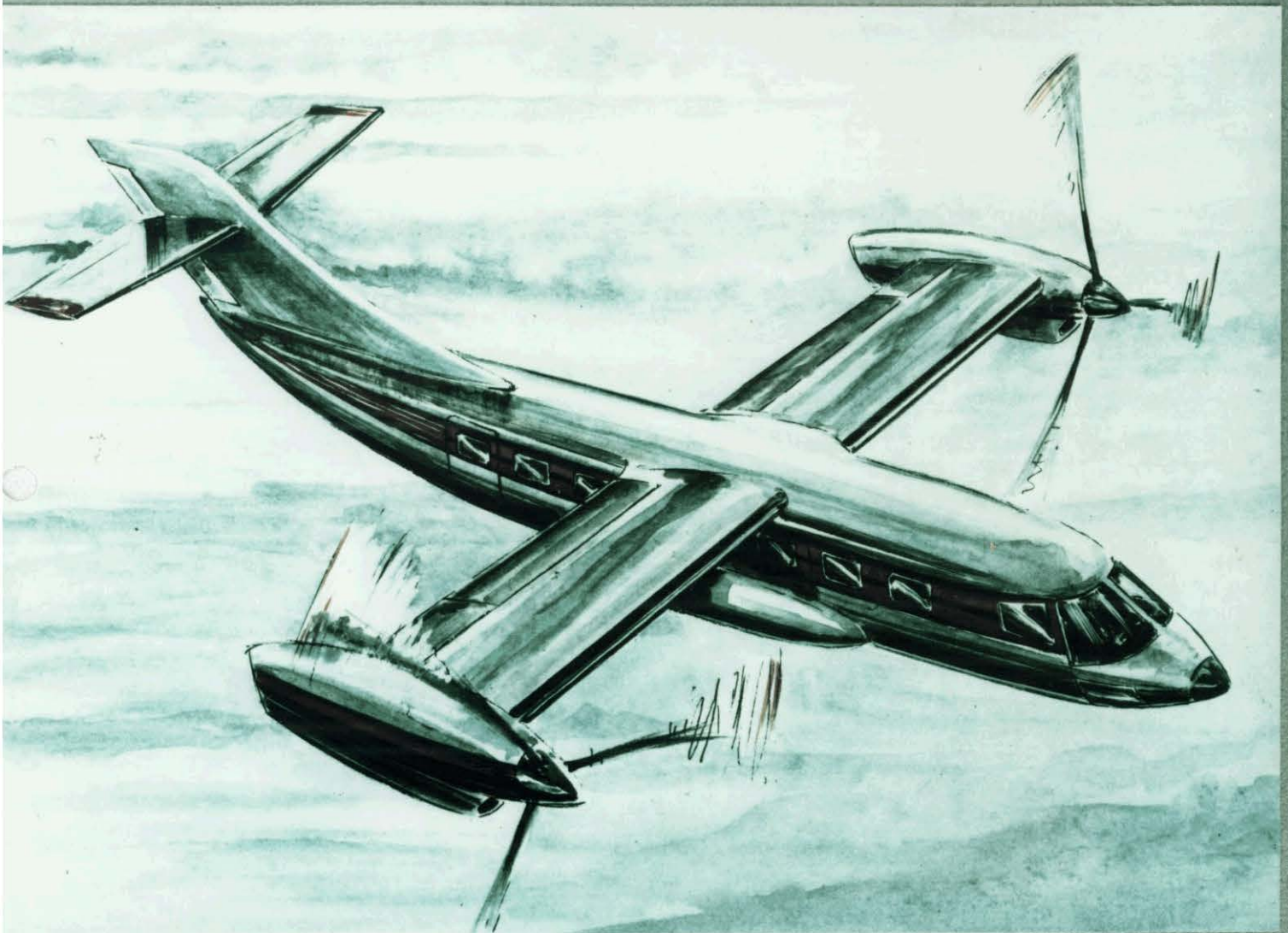

Fig. 19

EUROFAR SCHEDULE

aerospatiale

- * 18 DECEMBER 1985 : SUBMISSION OF AEROSPATIALE'S PROPOSAL TO FRENCH EUREKA SENIOR REPRESENTATIVE.
- * 27 FEBRUARY 1986 : FIRST MEETING OF EUROPEAN MANUFACTURERS
- * MARCH - JULY 1986 :
 - CONSTITUTION OF THE I.P.G (INDUSTRIAL PROJECT GROUP) AND THE I.M.C. (INDUSTRIAL MANAGEMENT COMMITTEE)
 - AGREEMENT ON A GENERAL COMMON APPROACH
 - DEFINITION BY I.P.G. OF THE ADMINISTRATIVE, FINANCIAL AND TECHNICAL COMPONENTS OF THE INDUSTRIAL ORGANIZATION TO BE SET UP FOR ACHIEVEMENT OF THE EUROFAR PROJECT PRELIMINARY PHASE. AGREEMENT BY I.M.C.
 - SET UP THE PROPOSAL
- * SEPTEMBER 1986 : TRANSMISSION OF COMMON PROJECT TO EUREKA'S SENIOR REPRESENTATIVES OF THE VARIOUS GOVERNMENTS CONCERNED.
- * NOVEMBER 1986 : PROJECT EXAMINATION BY THE EUROPEAN MINISTER CONFERENCE

19/24 - PASSENGER SEGMENT

aerospatiale

(* 1st PRODUCTION AIRCRAFT DELIVERY DATE)

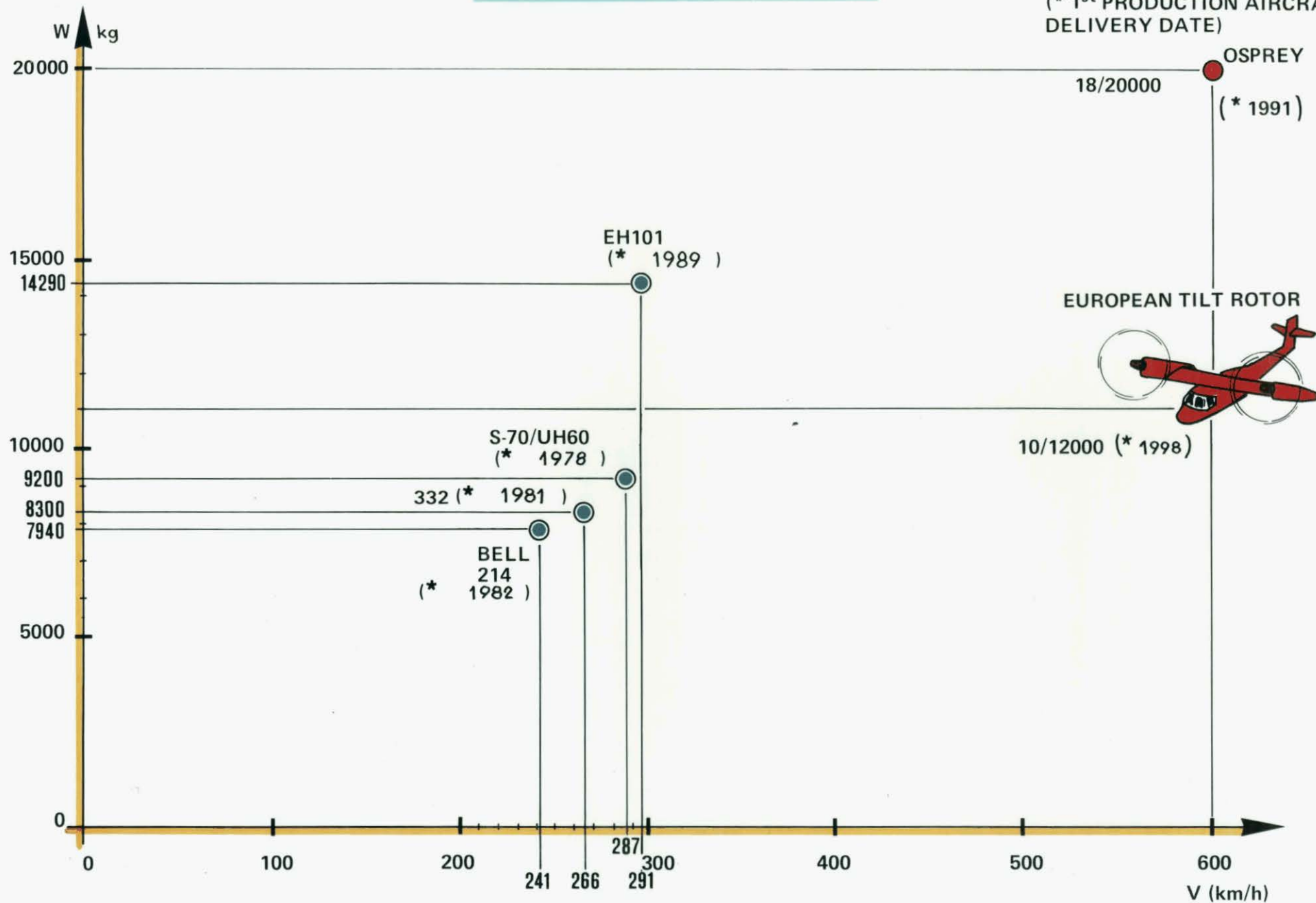

Fig. 21

SELECTED SEGMENT*

aerospatiale

BASIC MISSION : TRANSPORT OF 19 PASSENGERS
OVER 1000 km
AT 580 km/h AVERAGE SPEED
PRESSURIZED AIRCRAFT
AVERAGE CONSUMPTION : 1.2 kg/km
WITH 40 MINUTES RESERVE

MAXIMUM FERRY FLIGHT DISTANCE : 6000 km

TOTAL WEIGHT 10.200 kg*

ENGINES 2 x 2200 kW

* TO BE CONFIRMED BY MARKET STUDY

3 – VIEW DRAWING

aerospaziale

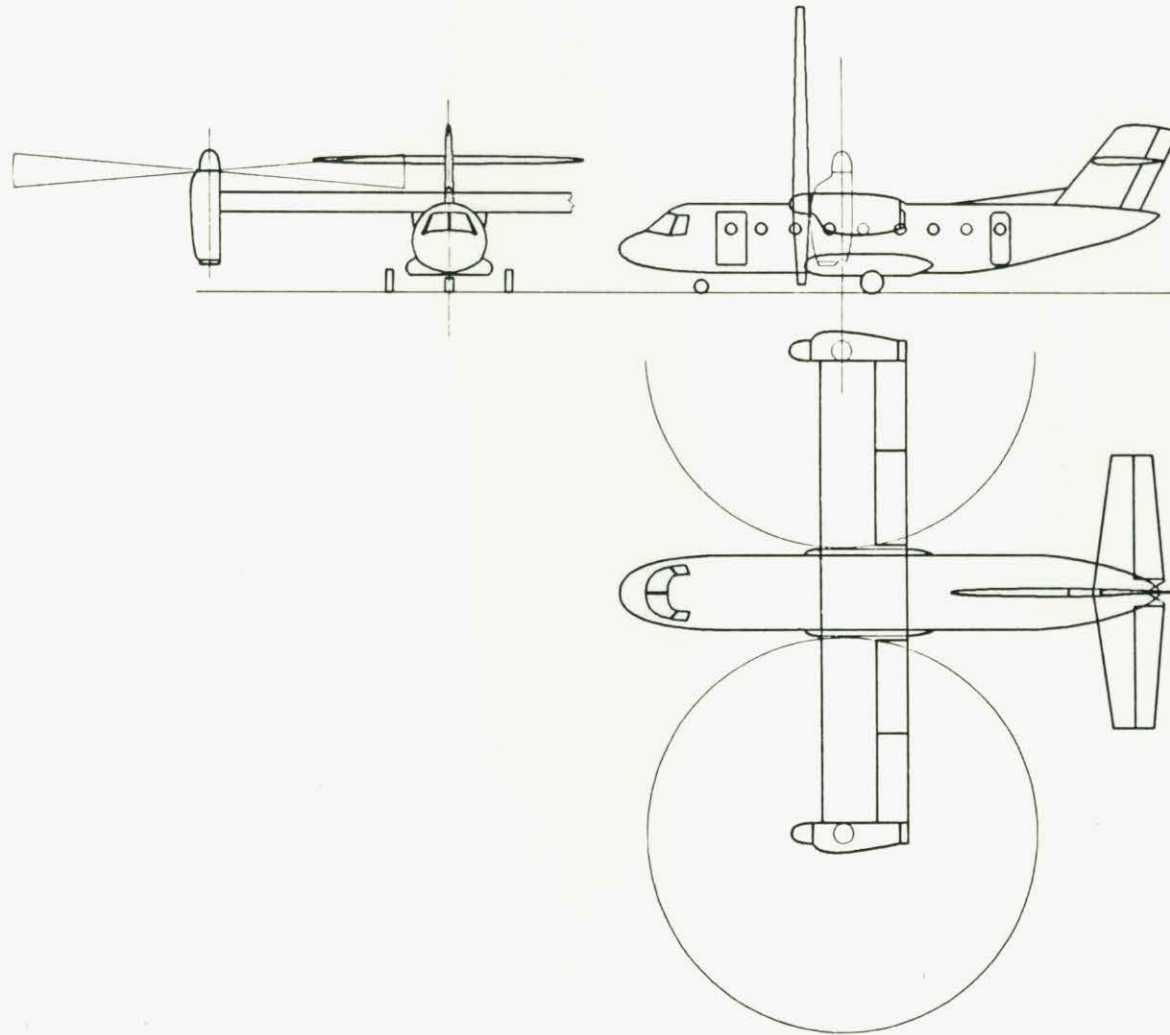

WEIGHT BREAK DOWN

aerospatiale

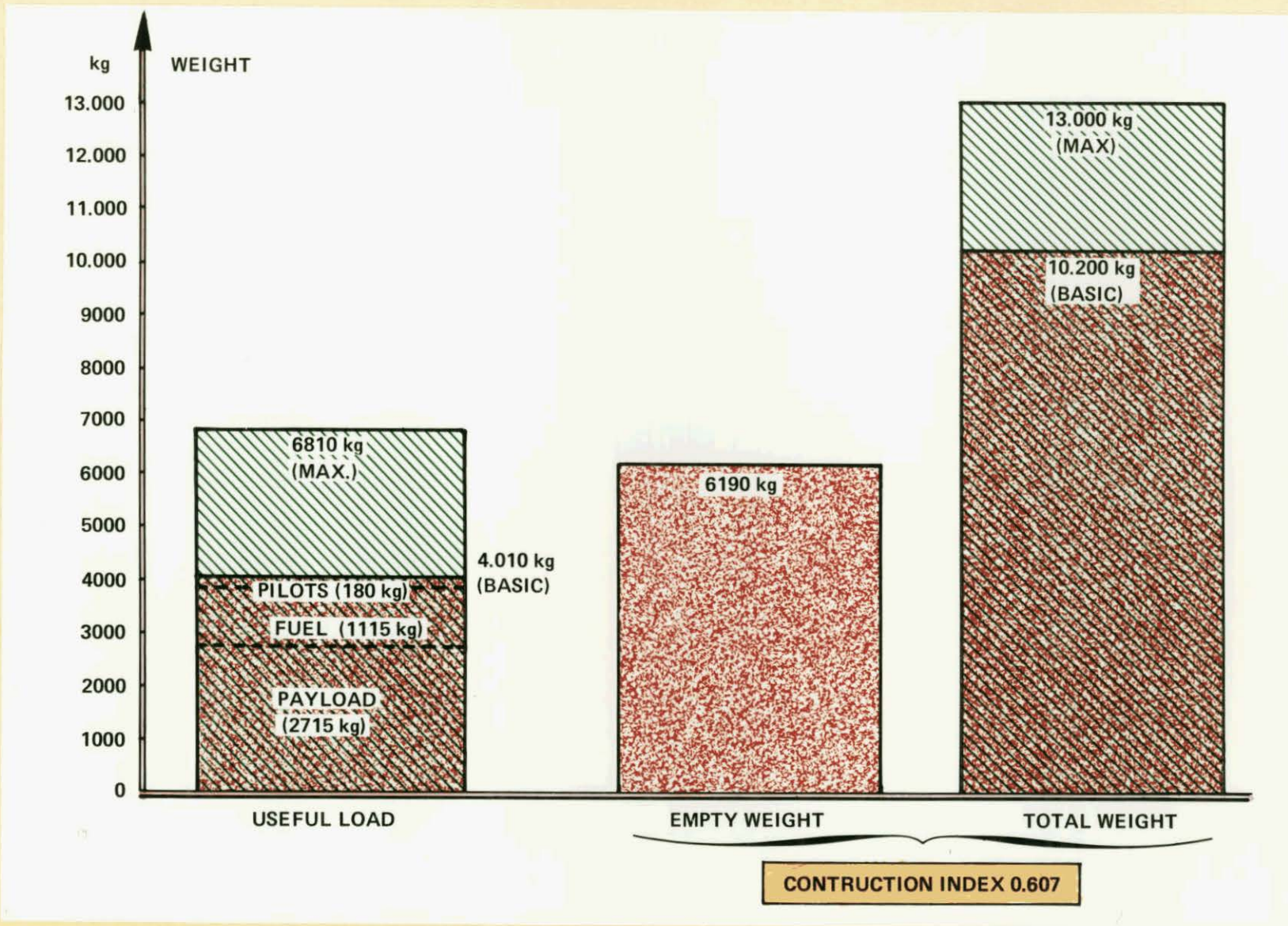

INTERNAL LAYOUT

aerospaciale

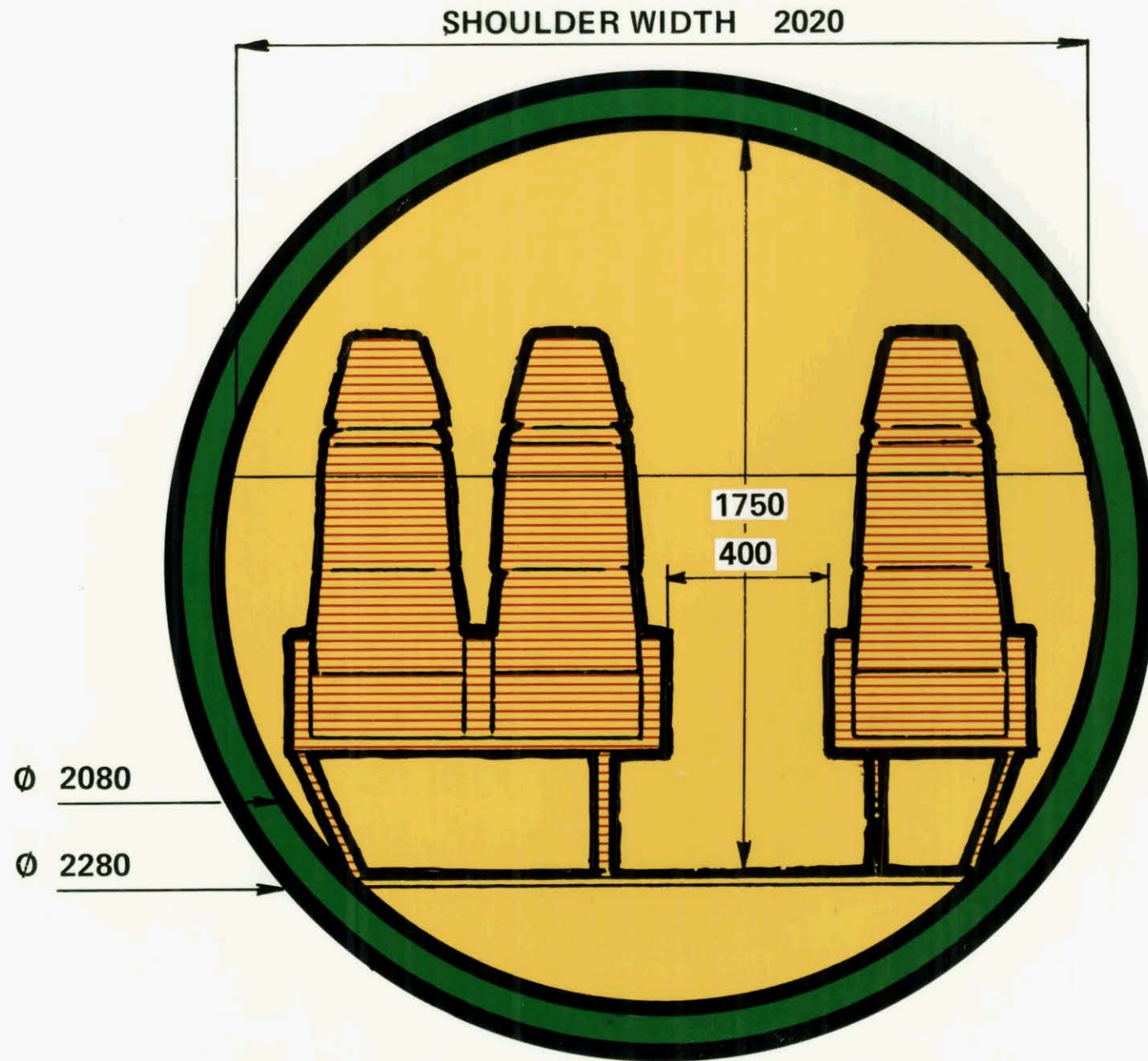

Fig. 25

USEFUL LOAD / RANGE CHART

aerospatiale

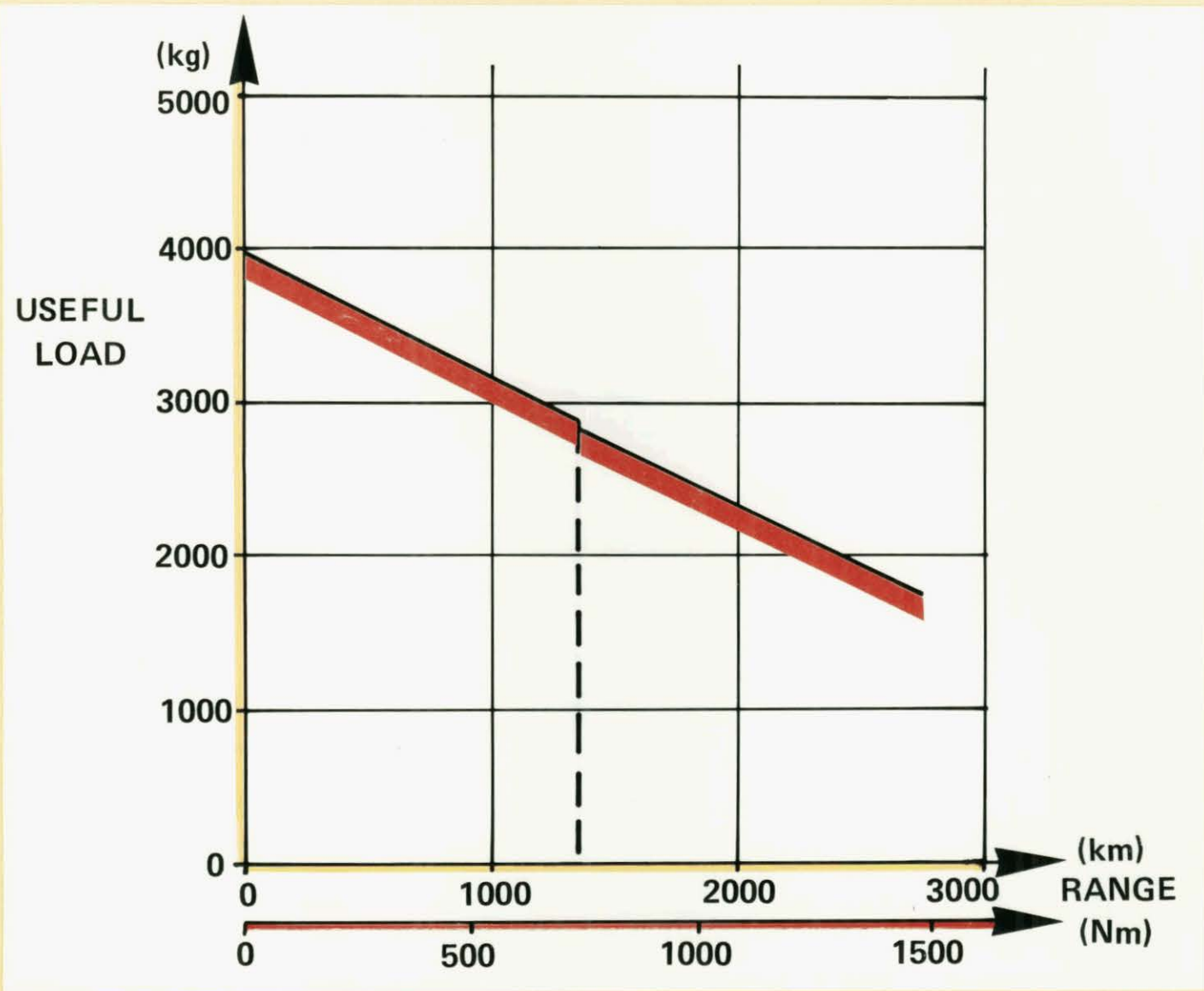

Fig. 26

CONSUMPTION PER KILOMETER

aerospatiale

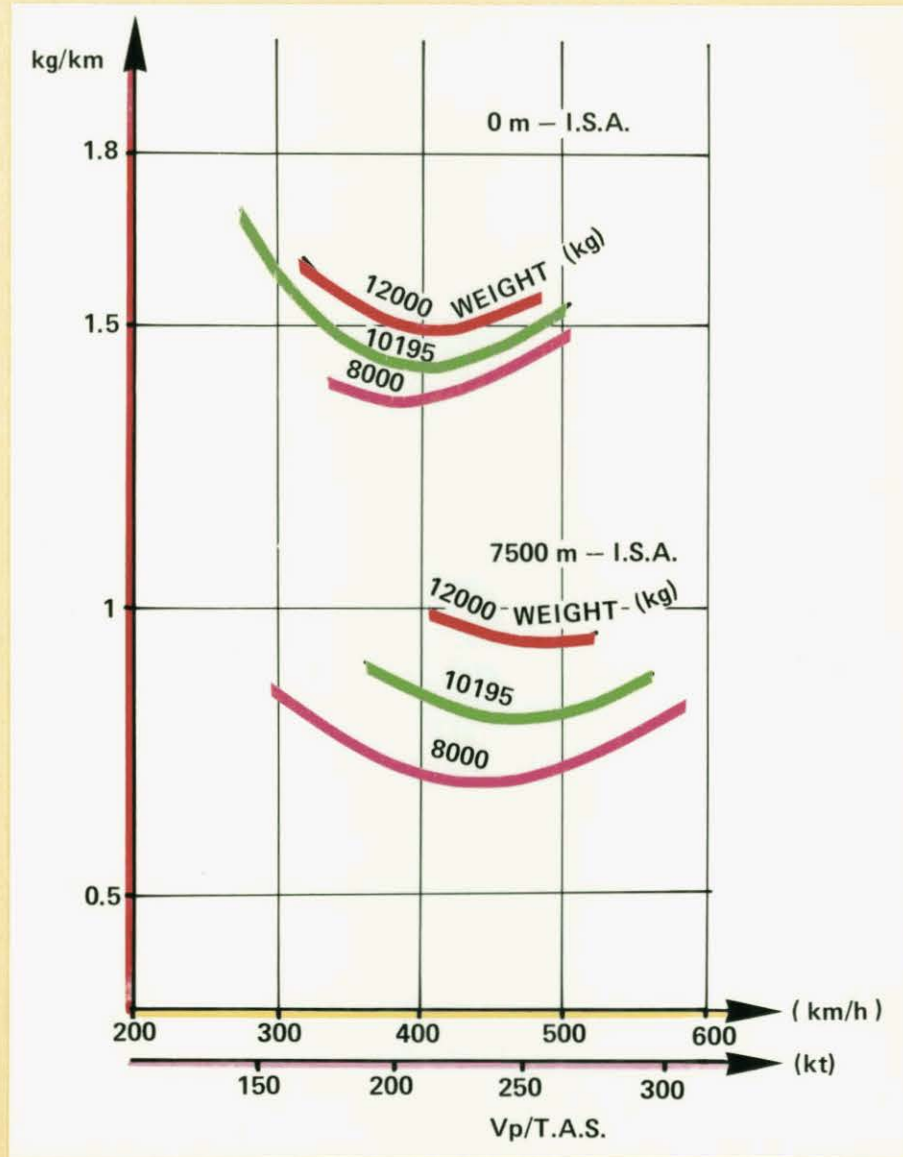

Fig. 27

AIRPLANE OBLIQUE CLIMB ON 1 OR 2 ENGINES

aerospatiale

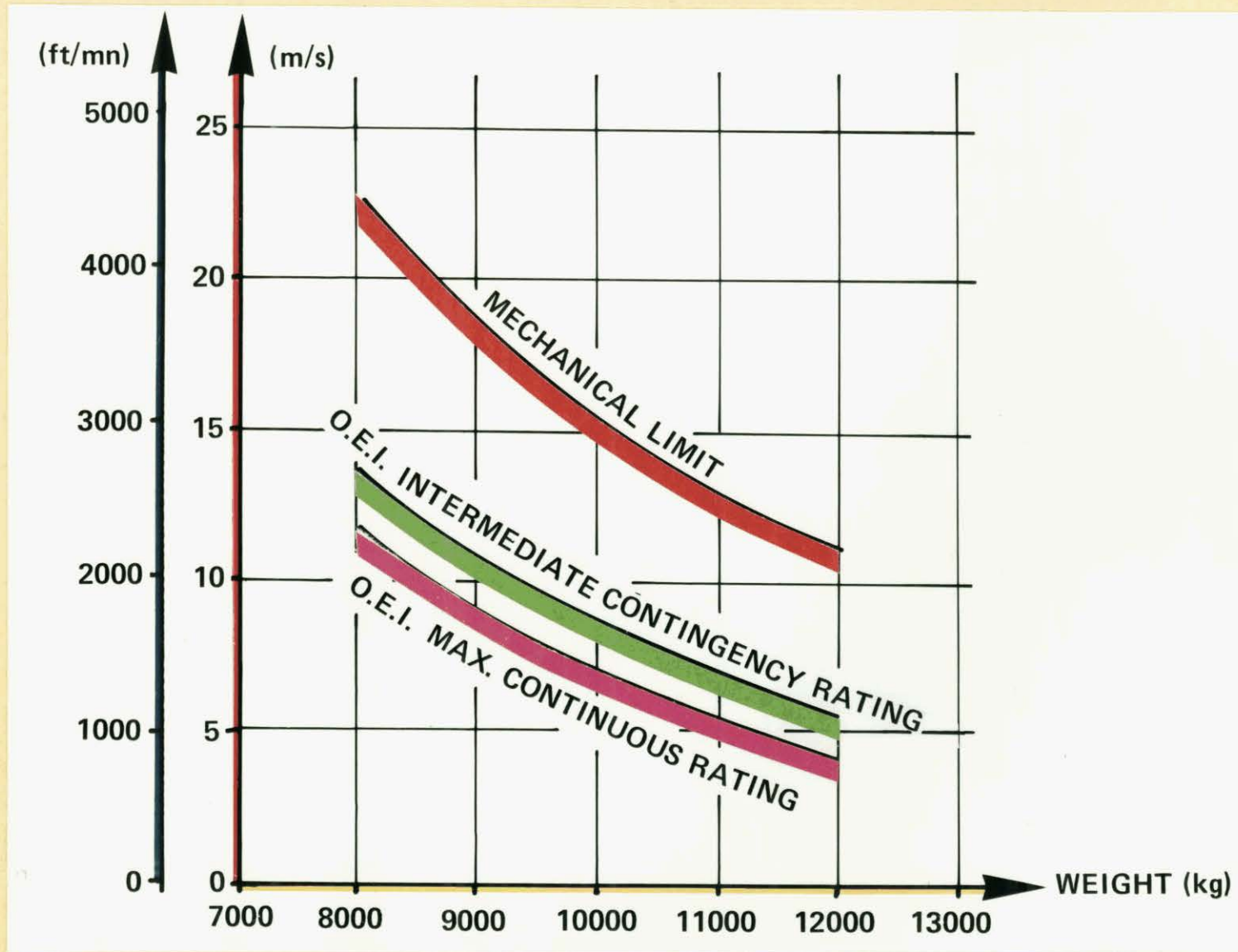

Fig. 28

HOVER CEILING O G E

aerospatiale



Fig. 29

FLIGHT ENVELOPE

aerospatiale

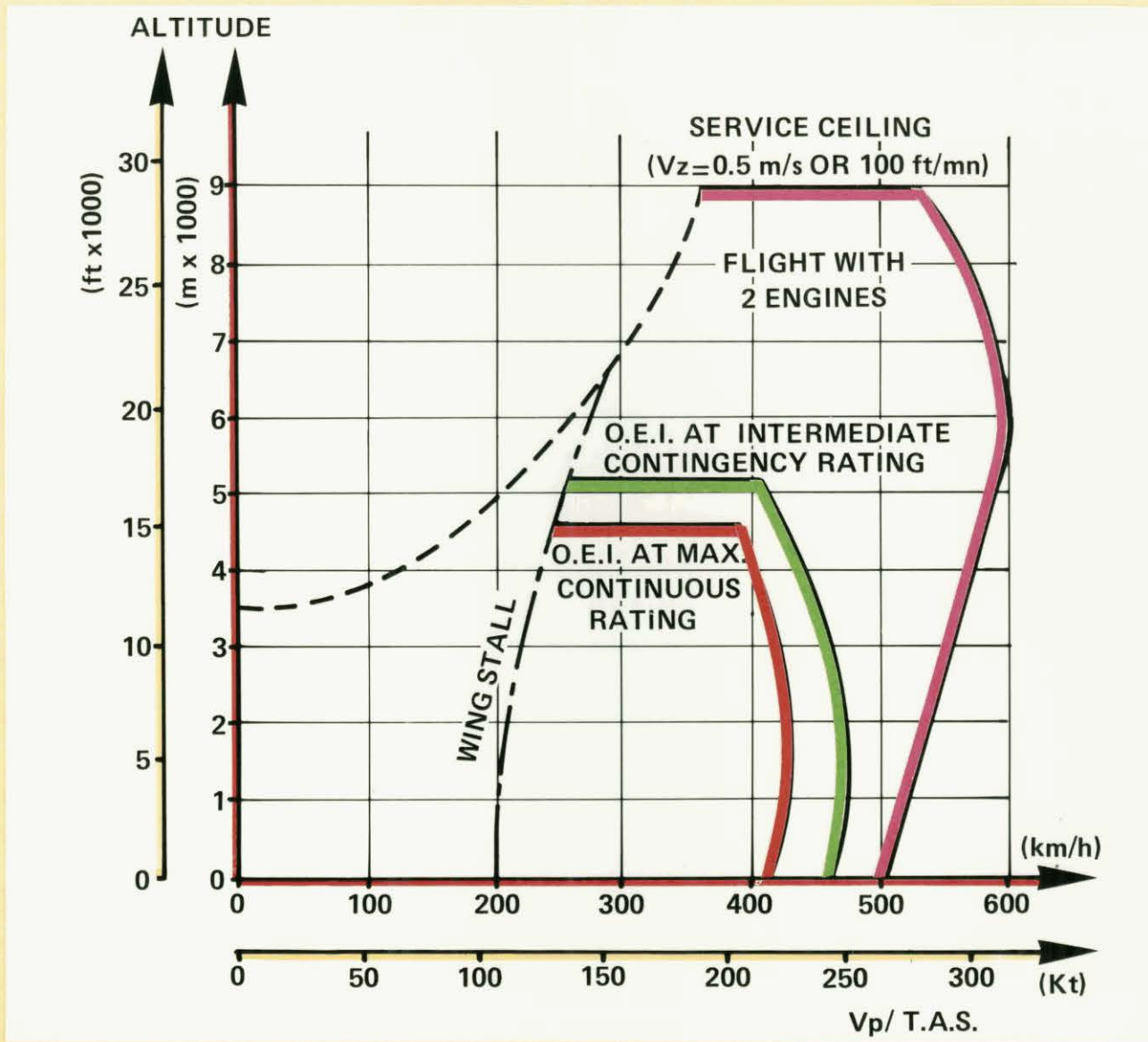

Fig. 30

OVERALL PROGRAM

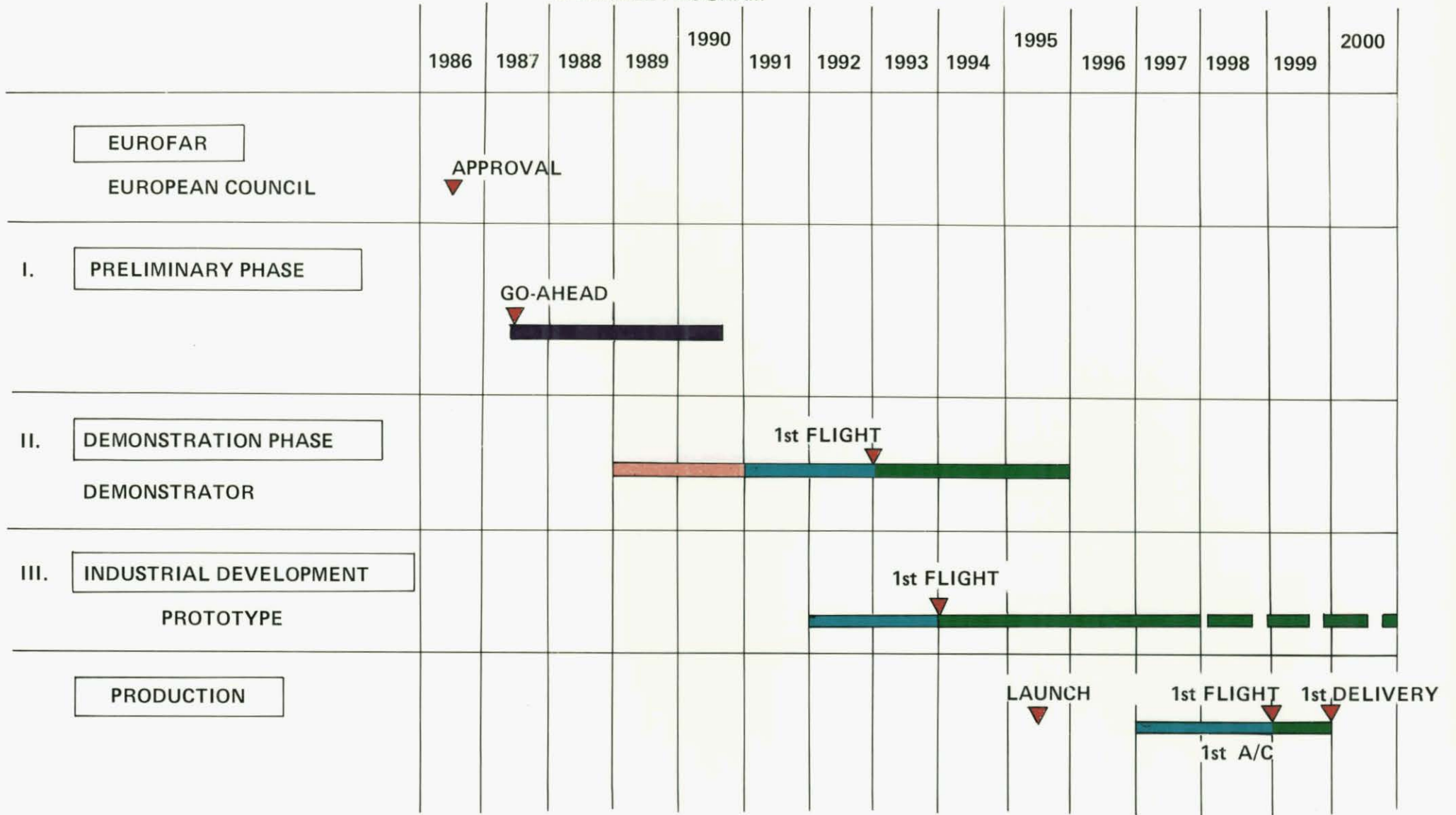

Fig. 31

EUROFAR

TIMETABLE FOR PRELIMINARY PHASE

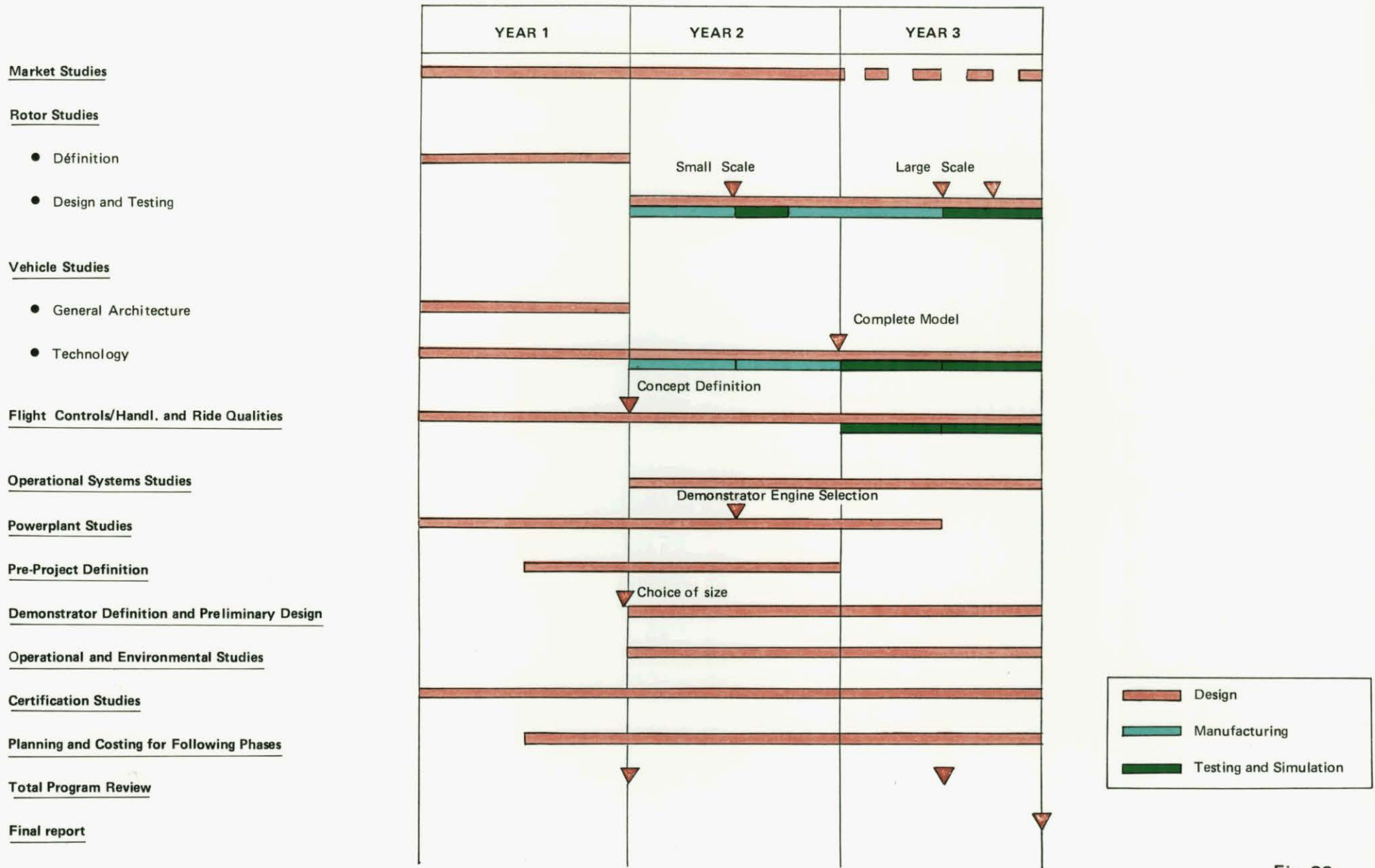

Fig. 32