

# Development of Mitsubishi MH2000 Helicopter

Takashi Kobayashi

Nagoya Aerospace Systems, Mitsubishi Heavy Industries, Ltd.

Kiyoshi Sakura

Nagoya Aerospace Systems, Mitsubishi Heavy Industries, Ltd.

## **Abstract**

The development of the MH2000 commercial helicopter was started in April 1995, following the long time experience on the licensed production for the Japanese Self Defense Force. This is the first purely Japanese-made commercial helicopter.

The paper presents the outline of the MH2000 development emphasizing its unique features for a short-term development. In addition to the short development period, MHI developed both the aircraft and its engine at the same time, which is the first case in the industry. To achieve the unique aspects of MH2000 development, we take some new approaches in design and manufacturing stages. Mitsubishi Heavy Industries, Ltd. (MHI) conducted a significant reduction of development period and development cost in order to minimize the risk of development with quick response to the market trends, introducing new features shown in this paper for the commercial helicopter in the twenty-first century.

## **Introduction**

After the long time experience on the licensed production for the Japanese Self Defense Force (JSDF) started from 1950's, MHI had another will to develop a commercial helicopter. For this purpose, element technologies have been accumulated in fundamental studies, while trial components have been manufactured to establish original technical basis. In addition, as a result of market research, along with promotion of operational deregulation and construction of heliports, it is expected that the demand in the Japanese domestic market will expand as the problems of noise, safety, ride quality and price are solved to establish operational advantages.

Element technologies have advanced to the level just before verification of an actual helicopter, and new technologies for solving the problems have been developed. Development of the RP1 prototype was started in July 1992 in order to avoid the risk of direct full development.

Throughout the manufacture of this RP1 prototype and various testing in ground and flight, the basic technologies for development of the helicopter and new techniques for realizing sales points have been proved. The technical background has been established, and methods of developing at lower cost and in a shorter time have been verified. The detail on the RP1 is described in the latter part of this paper.

On the basis of these achievements, the development of the first commercial helicopter, the MH2000, was started in April 1995.

## **Outline of MH2000**

The MH2000 is the first purely Japanese-made commercial helicopter (**Fig.1**). In addition, all of the most important dynamic components of the helicopter, namely, the rotor,



**Fig. 1** MH2000 Helicopter

transmission and airframe have been exclusively manufactured by MHI. In addition, the engine system for the MH2000 was developed by MHI at the same time. It was the first time in the world that a sole company developed a helicopter and its engine simultaneously.

Major technical features include the following, which are described in the next section.

- (1) Low noise
- (2) Ride quality
- (3) Safety
- (4) High performance
- (5) Economy

Development of MH2000 was started in April 1995 (Fig.2), and an application for the type certificate was submitted to the Civil Aviation Bureau, Ministry of Transport, on April 18. A preliminary T/C (Type Certification) board was held on May 10, and the type certification program was officially started. After the inspections and preflight T/C board on July 25-26, 1996, the maiden flight was successfully performed on July 29. The interim T/C board was held on March 27-28 and May 22-23, 1997, the final T/C board was held on June 11, and the type certificate was issued on June 26, 1997. During the certification program period, various and a number of flight tests are conducted with two prototype helicopters. The total amount of flight was about 300 flights and 500 flight hours. At the point of the T/C approval, MH2000 was opened to the public and sales activities started.

On the other hand, immediately after the Basic T/C is approved, an additional type certification program was started so as to improve

the operation capabilities, using the prototype helicopters. The type certificate amendment was issued on January 12, 1998.

While the Amendment T/C work was running, a design program for the production MH2000 has already started in the middle of 1997. Some additional procedures for certification including another flight tests are performed using both prototype and production-type aircraft through 1998 until middle of 1999, before the T/C for the production model was approved in September 1999. MHI had manufactured three production helicopter and the first one was delivered on October 1, 1999.

The engine, MG5-110, was simultaneously developed at MHI's aero-engine factory (Nagoya Guidance & Propulsion Systems), and its type approval was issued on June 9, 1997, in accordance with the Basic T/C of the aircraft.

As described above, MHI conducted a significant reduction of development period comparing with a traditional aircraft development. As a result of the short-term process, its development cost was minimized so as to correspond to the market trends, which minimized the risk of development at the same time.

For the first step of the business, after the Japanese type certificate was obtained, the MH2000 helicopter was delivered to the domestic market in a short period of time. The possible next step for the overseas market would be taken after well satisfactory results in the domestic market were confirmed and, from an engineering point of view, design feedback from the domestic customers has been done.

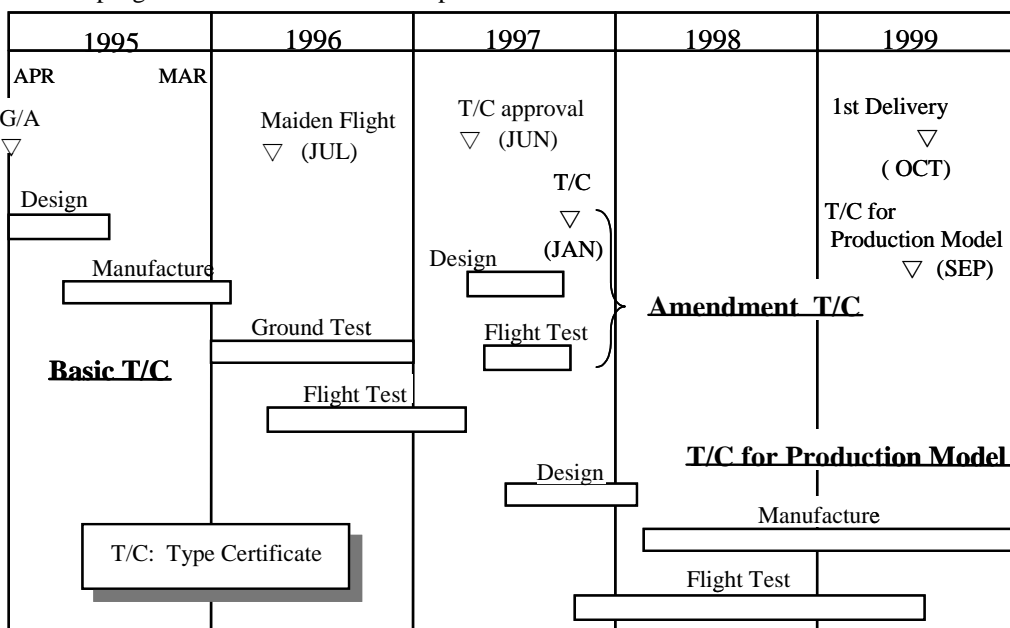

Fig. 2 MH2000 Development Schedule



glass fiber and carbon fiber (**Fig.7**). Its technology basis had been verified with the RP1 flight demonstrator. The main rotor head consists of a titanium hub, composite yokes and elastomeric bearings, and an elastomeric damper is applied. For the tail rotor system, the ducted fan type rotor was adopted mainly for the purpose of personal safety during operation. The fan consists of ten composite blades, an aluminum hub (**Fig.8**).

In addition, some unique features of MH2000 are summarized below. In its development, following items have been set as basic policy for the commercial helicopter business.

(1) Reduction of External Noise

- Newly designed main rotor blade with low noise and low vibration characteristics
- Two mode RPM operation with FADEC engine control

Incorporating two speed rotor system, the helicopter noise can be reduced with lower rotor speed combined with the use of low noise rotor when flying over the urban district. To attain this, it is necessary to control engine rpm by use of FADEC, as well as the optimum low vibration design for the blades having two rpm of operating speed.

(2) Comfortable cabin environment

- Spacious cabin
- Low noise and vibration level

Comfortable cabin environment can be attained by a high ceiling and spacious cabin with low noise and low vibration by changing the location of MGB from the directly above the cabin to rear to avoid the direct transmission of the high frequency gearbox noise. And the active noise control (ANC) is a possible option to suppress the main rotor high frequency noise effectively.



**Fig. 5 MG5-110 Engine**



**Fig. 6 Main Gear Box**

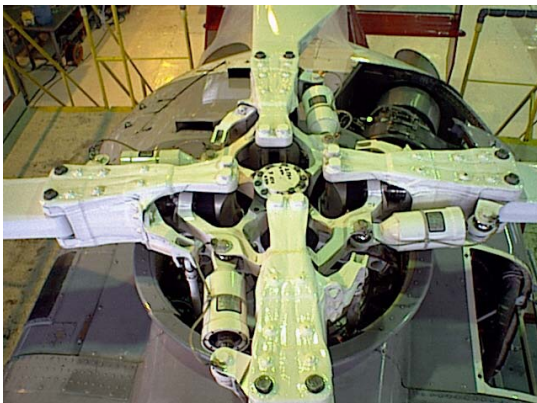

**Fig. 7 Main Rotor (Head)**

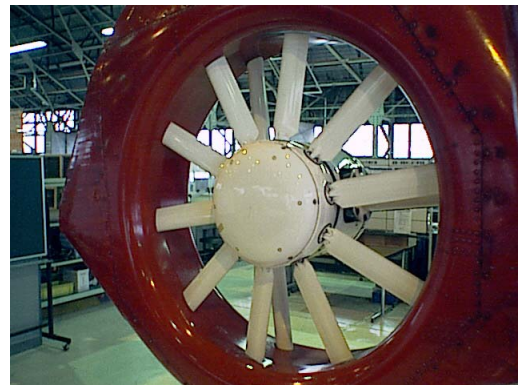

**Fig. 8 Tail Rotor**



(3) Safety features

- Twin engine and crashworthy design
- Map Display System (MDS) with GPS
- Automatic Flight Control System (AFCS)

Safety of operation can be enhanced and assured through use of dual engines, seats and fuel tanks that satisfy the latest crashworthiness requirements, MDS as an advanced collision avoidance system and AFCS. The MDS and the AFCS are made as the standard installation with due consideration to the cost reduction requirements. The MDS, developed by MHI, is a combined system of a map display. The AFCS is for limited function ( three axes SAS and pitch/roll attitude hold ) with the lowest possible cost.

(4) Superior performance

- Flight speed
- Range

An outstanding aircraft speed and range can be assured for various missions with high power engines and high performance rotor system.

(5) Operating economy

- Low price helicopter with low cost design
- Reduced Direct Operational Cost (DOC)

For economy of operation, an extremity will be pursued to achieve a low price helicopter. By concentrating electronic equipment into a single area at a rear avionics compartment, readily maintainable arrangement can be assured. A reduced DOC must be assured by use of high reliability components and equipments.

**Prototype Experiment : RP1** <sup>Ref.(1)</sup>

MHI has developed a proof-of-concept prototype helicopter prior to the MH2000 program, incorporating improved features which overcome the weak points of helicopters, e.g. noise, expense, lack of safety and comfort. In this part, some unique features of the prototype helicopter called "RP1" are mentioned. **Fig. 9** shows the photograph of RP1 flight test.



**Fig. 9 RP1 Flight Test**

The policy and the targets that MHI had planned to establish in developing the RP1 are as follows:

- (1) The airframe and the engine are to be developed simultaneously.
- (2) The first flight is to be made within two years of the go-ahead, and the required data is to be obtained within three years of the go-ahead.
- (3) Only one helicopter is to be manufactured. Therefore, no jigs are to be fabricated as a rule, and efforts are to be made to reduce the development cost through manufacturing by hand.
- (4) The components are to be categorized into those on which development efforts are concentrated and those on which no such efforts are focused.

The former are to be developed entirely anew by means of MHI's own technologies. The latter are to be made so as to minimize the development period and cost by such means as the use of components of other helicopter models.

- (5) The components on which development efforts are concentrated include the main rotor system, the main gear box, the engine, the vibration control device, etc.
- (6) The components on which no development efforts are focused include the landing gear, the fuel system, the hydraulic system, the electrical system, the tail rotor system, etc.

The outline of the helicopter designed and manufactured to meet such policy and targets is as follows. The major specifications of the helicopter are shown in **Table 1** and the arrangement of systems on board is illustrated in **Fig. 10**.

**Table 1 Major Specifications of RP1**

Main Rotor	Diameter :	12.2 m
	Number of blades :	4
Tail Rotor	Diameter :	2.43 m
	Number of blades :	4
Overall length :	15.0 m	
Overall height :	4.56 m	
Overall width :	12.2 m	
Maximum take-off weight :	3900 kg	
Number of crew :	6 including pilots	
Engines :	MHI MG-5 (2 units)	

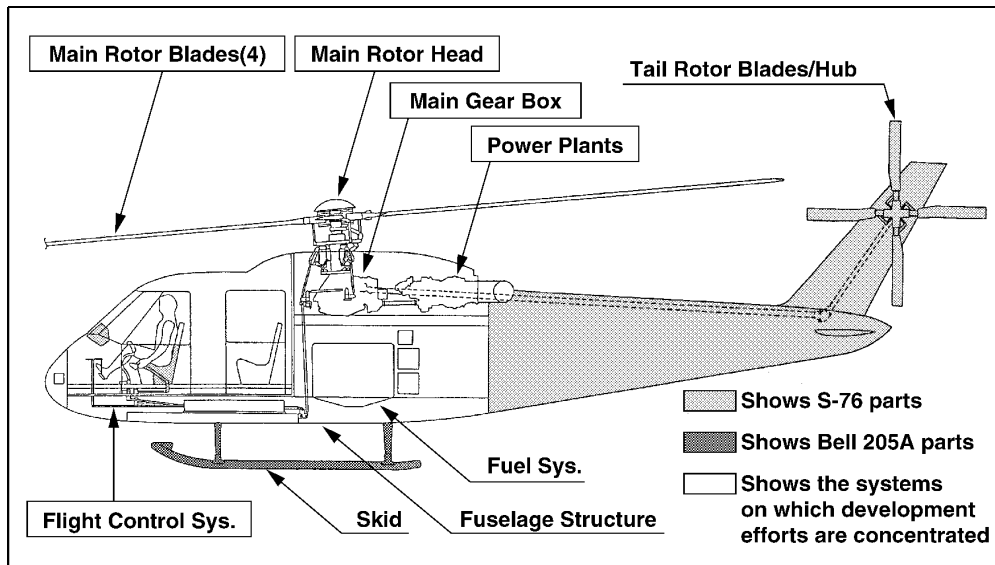

**Fig. 10 Arrangement of Systems**

To build the airframe, no jigs were fabricated and structures were hand-made. The airframe structures were designed in such a way to permit easy manufacturing by hand. For example, many trusses were used. The tail cone from another helicopter model was utilized with little modification.

The main rotor blades are all composite construction with glass fiber mainly used, in which a new airfoil developed by MHI is applied. The rotor head is fully articulated, and freedom of rotation in three axes is provided by means of an elastmeric bearing. A hydraulic damper is provided for the movement in the lead-lag direction. Because the helicopter is especially for experimental purpose, the hydraulic damper was chosen so as to change the viscosity coefficient easily. In the MH2000, an elastmeric damper is introduced as described before. As a result, almost same system is used for the MH2000 main rotor system except the damper.

The tail rotor system from another helicopter model was used in the RP1.

As regards the drive system, the main gear box was designed and developed by MHI especially for the RP1. Pertinent parts from another helicopter model were utilized for the intermediate and tail gear boxes, and some of the drive shafts.

As regards the flight control system, pertinent parts for the control sticks, the hydraulic servos, bell cranks and rods were utilized from another helicopter model. Meanwhile, the automatic flight control system (AFCS) and the

link mechanism were specifically developed for the RP1.

The fuel tank and the piping were manufactured to match this helicopter, while the pumps, the valves, etc. were utilized from another helicopter model.

Skid type landing gears from another helicopter model were installed.

For the twin engine system, the trial products of the MG-5 are used with the FADEC system also introduced. During the RP1 flight tests, a lot of useful data for the engine development were acquired as well as the helicopter itself. After some improvement was applied, the production MG-5 was adopted to the MH2000.

As regards the development tests, assuming approximately 200 hours flight testing, a great deal of efforts went into reducing the number of test items to the necessary and sufficient extent. As a result, the following tests are major examples which were conducted prior to the flight in the RP1 development.

Subsystem level

- Rotor system
  - Static and fatigue tests, Tower test
- Transmission system
  - Static, performance/durability tests of MGB, Functional test of lubrication system
- Engine
  - Functional/performance/durability tests on bench and aircraft
- Flight control and hydraulic systems
  - Static and functional tests
- Structures

Static test of critical areas

Complete helicopter level

- Static test (60% design limit load)
- Vibration test
- Complete helicopter ground functional test
- Tiedown test  
(50 hours with spectrum loading)
- Tethered hover test

After the tests shown above had been completed, the flight testing was started in September 1994.

In the course of flight testing, the flight envelope was being expanded step by step after obtaining data to confirm technical safety.

The go-ahead was given on the development at the end of July 1992, and large-sized parts were fabricated and assembled in approximately one year. The tethered hover test was conducted 21 months after the go-ahead, and the untethered flight tests had started 4 months after the hover. As the development period is concerned, the initial targets had been almost accomplished.

With the successful experience of the RP1, MHI had learned a lot about the short-term and low-cost development of the commercial helicopter, which led to the MH2000 program.

**Flight Tests for Type Certification of MH2000**

Various flight tests had been done during the certification process to verify the characteristics of the MH2000 for the regulation.

In the initial T/C phase, flight tests were

conducted using two helicopters, #1 and #2. And for the subsequent production T/C phase, additional flight tests were conducted using one production type helicopter #3.

The followings are typical examples of the initial “Basic” T/C test data.

As the MH2000 is fully new designed helicopter, great number of flights were conducted so as to acquire flight performance data. The helicopter #1 was mainly used for the purpose during the initial test phase. All data necessary to verify the design and certify the regulation were recorded in the air and analyzed on the ground after each flight was completed.

Fig. 11 is the chart for the required power to the airspeed, which is a typical result of the flight tests and described in the flight manual and so on.

The vibration level in flight is one of the most important characteristics for the helicopter development. Therefore, also in the MH2000 flight test, some flight tests were conducted to acquire vibration levels at various positions of the airframe, such as the pilot floor, the instrument panel and so on. In addition, several types of vibration reduction devices are tried during the initial flight test period. As a result of measurement and investigation of the flight data, a configuration for the vibration reduction is determined.

The following are some examples of the vibration reduction devices prepared for the flight tests of the MH2000. Each device was prepared prior to its first flight so that a ready-to-fit device would quickly be applied for any 4/rev

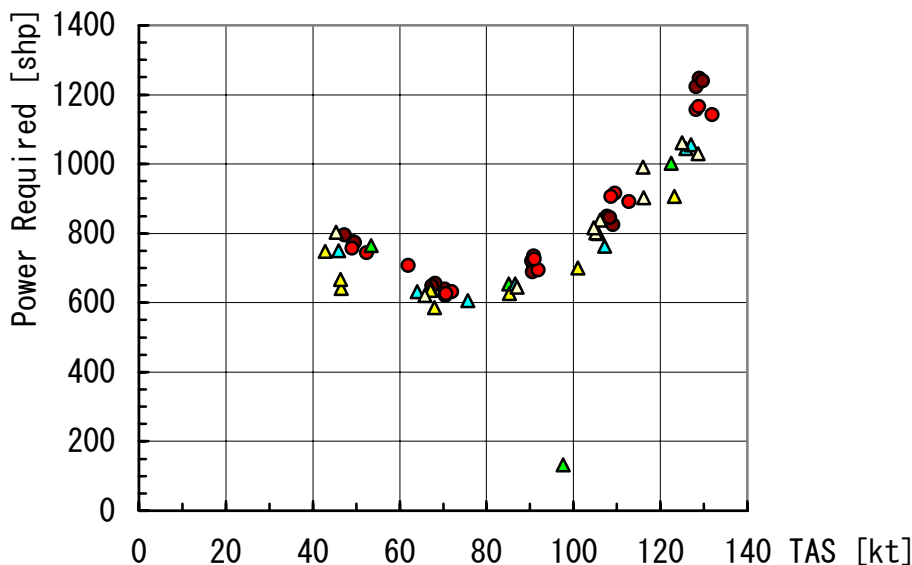

**Fig. 11 Required Power in Level Flight**

vibration problems encountered. Ref. (5)

- 4/rev vertical absorber
- 3/rev bifilar
- 5/rev bifilar

Fig. 12 shows the reduction level of 4/rev vibration in the vertical direction. From the figure the high effectiveness in 4/rev vibration reduction by the vertical absorber can be observed

The noise certification flight test was conducted in Hokkaido area through September to October 1997. The detail test procedure was according to the Japan Civil Aviation Regulation which is based on the ICAO Annex 16 Chapter 5.

Fig. 13 shows the typical result of the noise certification test and comparison with the other helicopters. In the figure, the measured noise level is below the limit for the flyover condition. Furthermore, the noise level also satisfies the new limit effective from 2002.

All data not only in the flyover case but also the take-off and the approach cases were proved to satisfy the ICAO limits.

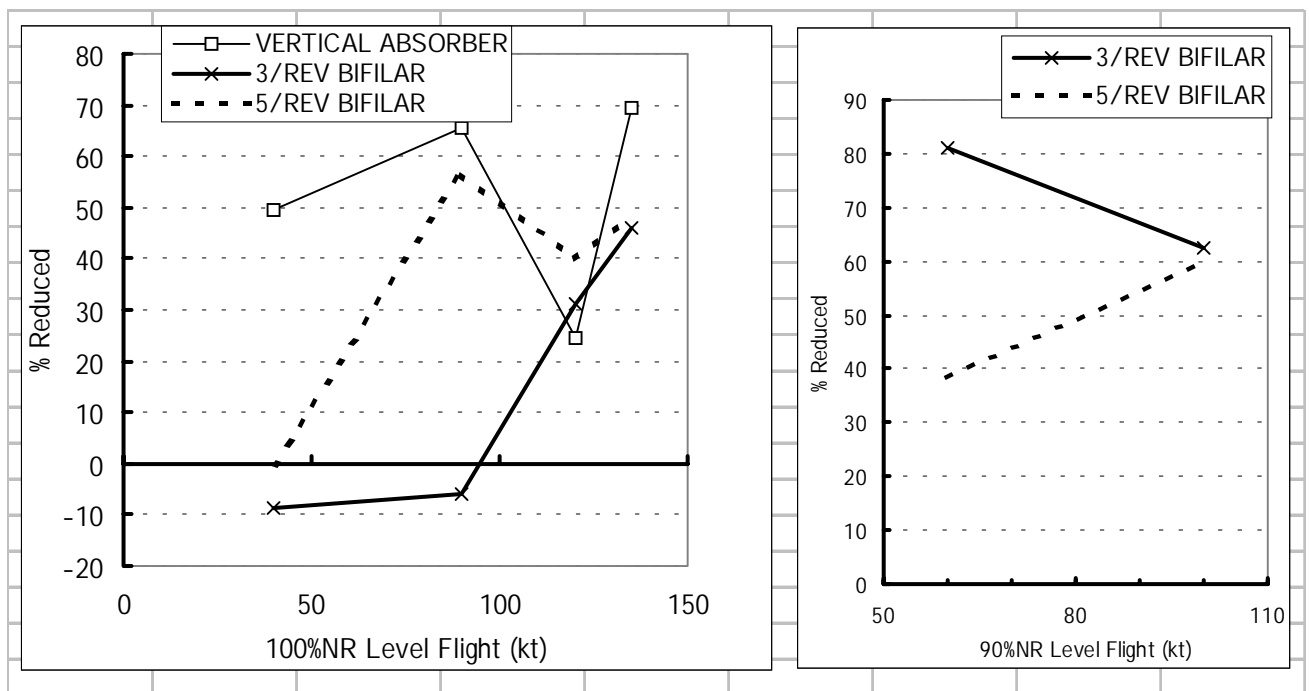

Fig. 12 Reduction in 4/rev Vertical Vibration

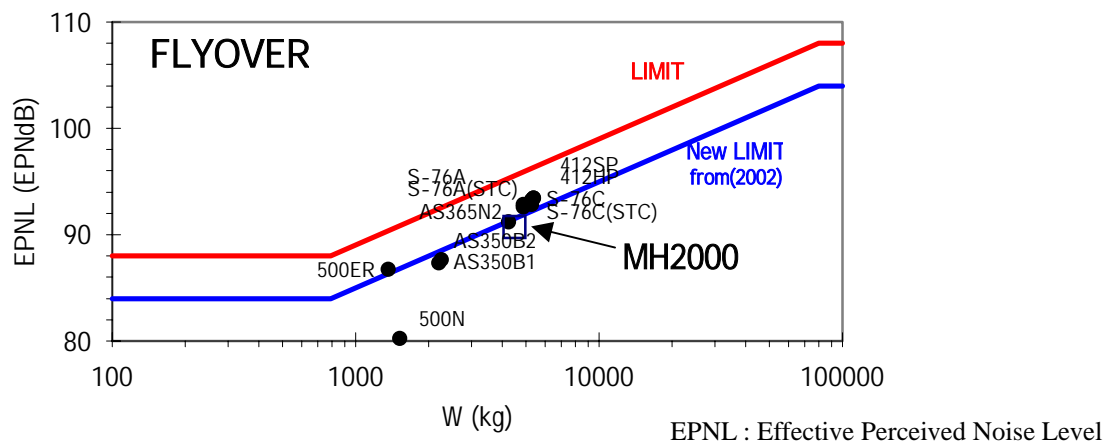

Fig. 13 External Noise Level



### **Future Plan of MH2000**

Helicopter is considered one of the best fit transportation media for the Japanese local situation. Approximately 1000 commercial helicopters are in service in Japan to date and this number is almost a half of the total Japanese general aviation. Therefore, MHI expects considerable expansion of market demands for helicopters if the appropriate hardware and the framework of society are provided.

With the recognition of this situation, MHI plans to continue the commercial helicopter business with enhancing the performance of the MH2000.

- More comfortable cabin : low vibration and noise
- More silent external noise
- High quality cabin interior
- Enhanced autopilot (AFCS)
- IFR (Instrument Flight Rules) operation
- High flight performance : higher cruise speed
- Much easier maintenance

Realizing such advanced features, the MH2000 can be used for more versatile use such as EMS, rescue, broadcasting and offshore not only in a domestic area but also an international field.

### **Conclusions**

- (1) Mitsubishi Heavy Industries, Ltd. (MHI) has started the development of the MH2000 helicopter in order to extend its business in the Japanese commercial helicopter market.
- (2) As a development of an entirely new commercial helicopter, MHI introduced the short-term process in design and manufacture fields and some unique technical features are applied to the helicopter, following the experience of the prototype RP1.

- (3) By the acquisition of a type certificate (basic, amendment and for the production model), the MH2000 began to fly in the skies of Japan as a commercial helicopter. This was the first step for the commercial production of the MH2000.
- (4) The production design was promoted in parallel with type certification work. MHI had manufactured three helicopters as the first lot of production MH2000 to date, which had been delivered for the customers.
- (5) It is further planned to promote the production project while enhancing the performance of the MH2000 in various aspects so that the helicopter can be operated for versatile use.

### **References**

- (1) Toda, N., Harada, T., and Sato, A., "Rapid Prototype Development of the Mitsubishi RP1 Helicopter", American Helicopter Society 55<sup>th</sup> Annual Forum, Montreal, Canada, May 1999.
- (2) Toda, N., "Review of MHI Helicopter Development", Heli Japan 98, Gifu, Japan, April 1998.
- (3) Toda, N., Kobayashi, T. et al., "Application of MH2000 Commercial Helicopter", MHI Technical Review Vol.36, No.2, June 1999.
- (4) Kobayashi, T., Sakura, K., "Development of MH2000, New Commercial Helicopter", American Helicopter Society 56<sup>th</sup> Annual Forum, Virginia Beach, Virginia, May 2000.
- (5) Kobayashi, T., Ikuta, M., "Vibration Reduction Designing for MH2000 Development", American Helicopter Society 57<sup>th</sup> Annual Forum, Washington DC, May 2001.