

SIXTH EUROPEAN ROTORCRAFT AND POWERED LIFT AIRCRAFT FORUM

Paper No. 45

ASW HELICOPTER/SONAR DYNAMICS MATHEMATICAL MODEL

C.R. Guy, M.J. Williams and N.E. Gilbert  
Aeronautical Research Laboratories  
Melbourne, Australia

September 16-19, 1980  
Bristol, England

THE UNIVERSITY, BRISTOL, BS8 1HR, ENGLAND

# ASW HELICOPTER/SONAR DYNAMICS MATHEMATICAL MODEL

C.R. Guy, M.J. Williams and N.E. Gilbert  
Aeronautical Research Laboratories  
Melbourne, Australia

## ABSTRACT

A mathematical model of a typical anti-submarine warfare (ASW) helicopter and its sonar system is presented. The model represents both performance and dynamic flight behaviour over a wide range of conditions and incorporates the aerodynamics/kinematics of the helicopter, the control systems, pilot inputs, the cable/sonar dynamics and wind/sea state data. The aerodynamics/kinematics is a three dimensional representation covering the operating flight envelope, where rotor aerodynamics are based on blade-element and actuator-disc theory. The control systems contain models of both the flying controls and automatic flight control system, and the sonar cable and transducer model is formed by a number of attached, rigid links. Consideration of the forces acting on each link enable the three-dimensional shape and motion of the complete cable and transducer to be predicted.

## 1. INTRODUCTION

During the past 15 years, the Australian Defence Science and Technology Organisation has provided scientific assistance to the Royal Australian Navy (RAN) in the area of helicopter operations. This work began when RAN modified its Westland Wessex Helicopters to a new standard, which included the fitting of a replacement sonar to improve anti-submarine warfare performance<sup>1</sup>. In the type of sonar used, the transducer is lowered into the sea on a cable suspended from the helicopter when in hovering flight (known as the cable hover mode of operation - Fig. 1) and submarine detection information from the transducer is routed via the cable to processing equipment in the aircraft. In order to obtain optimum performance, the transducer must be kept still and upright in the water. To do this, the assumption is made that by altering the plan-position of the top of the cable through helicopter motions, transducer movement can be controlled. Consequently, if plan-position is adjusted to minimize cable deviation angle from the vertical at the suspension point, then the transducer should remain still and upright in the water. For effective operation, automatic control of the helicopter is required, where cable deviation angles in pitch and roll are sensed at the suspension point and used as inputs to the aircraft flight control system.

A problem which arose during the Wessex modernization programme was the instability of the aircraft in the cable hover mode. To investigate this, a mathematical model of the complete aircraft/control system/cable was developed<sup>1</sup> which enabled prediction of the dynamic behaviour of the complete system in this mode. In addition, the behaviour of the aircraft part of the model was considered sufficiently realistic for a wide range of flight conditions that other aspects of ASW manoeuvres, such as automatic transitions involving flight from cruise to hover and vice versa, could be investigated. The model was used to solve the problem, which stemmed from incorrect gain settings in the automatic flight control system.

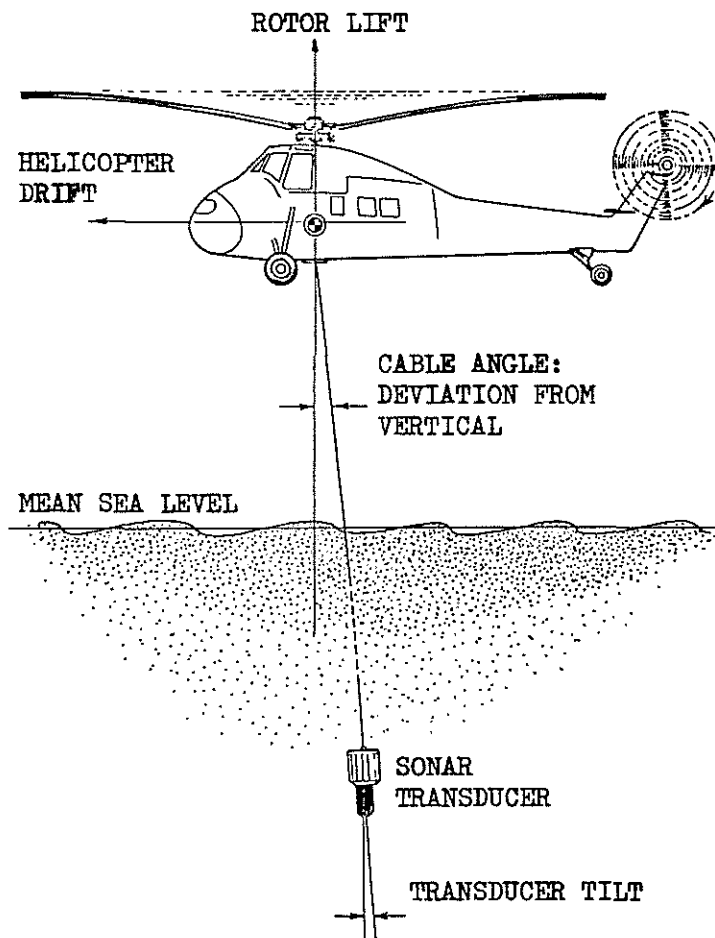

Fig 1 Wessex in cable hover (ref 1)

Because of the success of this work, RAN asked that a model of the Sea King Mk.50 helicopter be developed when this aircraft and its simulator were acquired about 1975. While no inherent instability problems have occurred with Sea King, the model is considered to be a useful tool for supporting aircraft and simulator operations. For example, a proposal was made during 1978 to further update the Wessex aircraft which included the fitting of a Sea King flight control system. A feasibility study<sup>2</sup> was performed using the Wessex aircraft model combined with the Sea King control system model to check dynamic flight behaviour and the need for alteration of system gains and time constants. While the Sea King model has been developed from the Wessex, it has more sophistication in the aerodynamics representation to produce a more accurate simulation, and additionally a completely revised control systems model.

Previous work on a similar system to the one described here was undertaken as long ago as 1960 by Plessey (U.K.) Ltd., using an analogue computer. However, the models used for both aerodynamics and control systems were very simple and only valid for small perturbations from steady forward flight. More recently, many other models for helicopter simulation have evolved (e.g. Wilcock<sup>3</sup>, Austin and Vann<sup>4</sup>), while some descriptions of flight control systems for ASW helicopters have also appeared (e.g. Collomosse<sup>5</sup>, Snelling and Cook<sup>6</sup>). The model described here, which is a development of the Wessex study made by Packer<sup>1, 7-9</sup>, is a versatile dynamic study for the Sea King Mk.50 helicopter/control system/cable, designed for use on a digital computer and programmed in CSMP-10 (ARL) simulation language.

## 2. MODEL FORMULATION

A block diagram, showing the relationships between the major components of the complete model and specifying the inputs and outputs from each component, is given in Fig. 2. Data for the aerodynamics were supplied by Westland Helicopters Ltd. and enabled a detailed aerodynamics/kinematics model to be formulated, based on the physical theory established in ref. 7. Data and information for the control systems were obtained from a variety of sources, including tests on aircraft equipment, manuals, circuit diagrams and data on fundamental control laws supplied by Louis Newmark Ltd. The data for the cable/sonar transducer were obtained from wind-tunnel tests on a scale model of the transducer and from information supplied by Bendix. This model uses the theory developed in ref. 8.

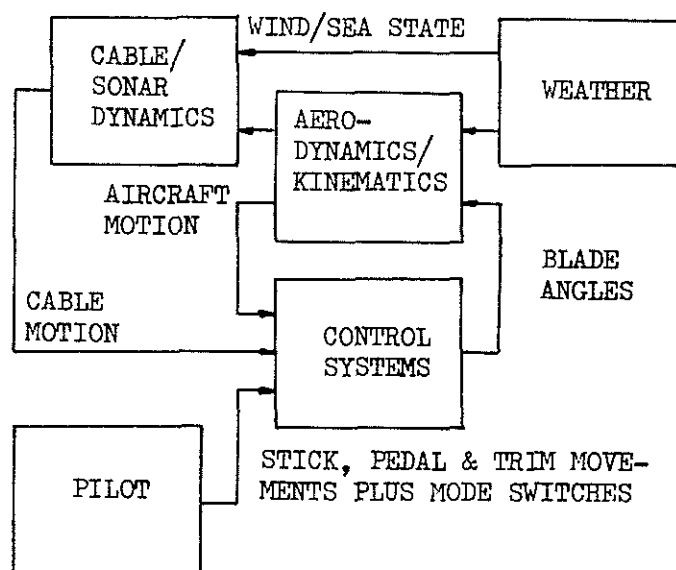

Fig 2 Model block diagram

The aerodynamics/kinematics model is a three-dimensional dynamic representation where the rotor aerodynamics are based on blade-element and actuator-disc theory, rather than detailed wake modelling techniques. In this way a realistic, manoeuvrable and versatile model, which does not require excessive computing time for its operation, is formulated.

The aircraft control systems, which comprise a number of inter-connected mechanical, hydraulic and electronic sub-systems, are modelled in two parts - the flying controls and the automatic flight control system. The latter can itself be subdivided into an autostabilizer/autopilot mode and an ASW mode. Both individual components and overall systems are modelled so that the characteristics of the control systems are adequately represented.

In the cable/sonar model, the cable and transducer are represented by a number of attached rigid links, and the effect of the cable touching the funnel rim is included. The model enables dynamic simulation of the system behaviour during sonar dunking operations, but does not take acoustic performance or lowering and raising operations into account. Quantities obtained from the model at the cable suspension point provide inputs to both the aerodynamics/kinematics and control systems models.

The pilot model shown in Fig. 2 comprises logic, switches and variable functions. The logic and switches are used to actuate the various facilities of the control systems, with functions being used for trim settings, pilot's stick and pedal movements. No attempt is made to simulate pilot response as part of the control loop.

In order to model the aircraft/control systems/cable behaviour under operational conditions, provision is made to include weather conditions in the simulation. Both steady and gusting winds in any direction relative to the earth can be specified, together with surface wave and velocity-depth sea current profiles.

### 3. AERODYNAMICS/KINEMATICS MODEL

The model is a dynamic, three-dimensional representation of body motion with six degrees of freedom (see Fig. 3). Main and tail rotor flapping motions are calculated but the rotor is considered quasi-static, in that the disc is assumed to respond instantaneously to the motion of the fuselage. The inclusion of cross-coupling terms, such as arise from angular rates, means that the model is not limited to small perturbation studies. It is considered to be capable of predicting low rate dynamic response manoeuvres, together with performance characteristics, within the lower speed range of the flight envelope. Operation up to an advance ratio ( $\mu$ ) of 0.3 is of interest but the range of validity of the model has yet to be established as it is obviously dependent on the assumptions made. These are now discussed briefly.

#### 3.1 Main Rotor Aerodynamics

Using blade element theory, forces and moments at the hub (origin of axes of no feathering - ANF axes) are obtained by integration of blade element forces with respect to radius and azimuth. The expression for the normal air velocity component at the blade element,  $U_p$ , includes helicopter angular rate terms. The following assumptions are made:

- i Blades are infinitely stiff in torsion and bending and hence second order flapping terms are ignored.
- ii Reverse flow, blade stall and compressibility effects are absent. At the highest speed of 120 knots ( $\mu=0.3$ ), it is likely that compressibility and stall effects become evident.  
Analysis of recent flight test data<sup>10</sup> is expected to provide a test of this assumption.

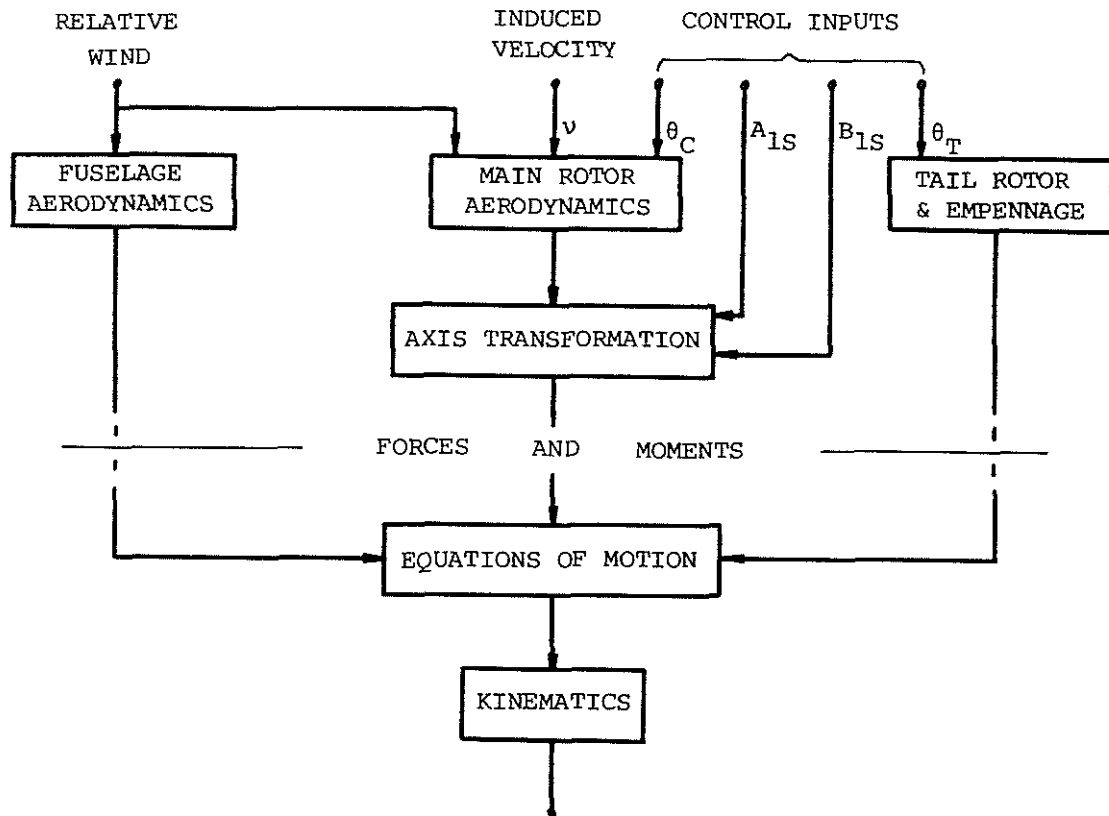

Fig 3 Structure of aerodynamics/kinematics model

- iii Induced flow is described by a Glauert-type distribution where the inflow increases linearly with distance downstream from the leading edge of the rotor disc. The degree of longitudinal variation depends on advance ratio while the mean value is given by momentum theory.
- iv Small angle approximations are used.
- v Blade element profile drag coefficient is independent of incidence.

Calculation of total rotor inflow and thrust coefficient is determined from an implicit relation which is solved iteratively. Within the loop are allowances for blade tip losses and ground effect. Tail rotor thrust coefficient is determined in a similar manner.

### 3.2 Axes Transformation

Rotor forces and moment coefficients calculated in the ANF axes system (in this case the XOZ plane contains the incident wind vector) undergo successive transformation to wind axes, shaft axes and body axes, so that summation with fuselage and tail aerodynamic forces and moments can be made.

### 3.3 Aerodynamic Body Forces

Pending the acquisition of suitable wind tunnel data relating to fuselage and empennage forces and moments, recourse was had to the expressions used in the math. model of the RAN Sea King Simulator<sup>11</sup>. While these expressions describe behaviour at high angles of sideslip and attack, they are based on limited wind

tunnel data and their accuracy under these conditions is uncertain, but likely to be adequate for low advance ratio flight. In order to duplicate the pitch trim variation with speed, an empirically based weighting function modifies the pitch moment arising from downwash effects on the fuselage and tailplane.

### 3.4 Dynamics and Kinematics

Classical equations of motion, expressed in helicopter body axes, are written in terms of transformed rotor and aerodynamic forces and moments together with gravitational and cross-coupling accelerations. Using Euler angle notation, a matrix transformation gives the helicopter velocity and position in the earth axes system. When combined with the ambient wind conditions, the magnitude and direction of the incident wind vector is established and hence the orientation of the ANF axis system.

### 3.5 Control Inputs

In the case of cyclic pitch inputs, allowance is made for control phase angle and steady state blade lag angle when converting to actual blade angle changes. Pitch-flap and pitch-lag coupling are allowed for in determining the effective collective blade angle.

### 3.6 Rotor Speed

As a suitable model of the rotor speed control has not been developed, the rotor angular velocity is assumed constant. The yaw response, however, is made subject to a first-order lag in order to model the effect of rotor deceleration under a sudden load.

## 4. CONTROL SYSTEMS MODEL

For the model, the control systems comprise the flying controls, AFCS (both autostabilizer/autopilot and anti-submarine warfare modes) and sensors. The overall configuration of these components is shown in Fig. 4.

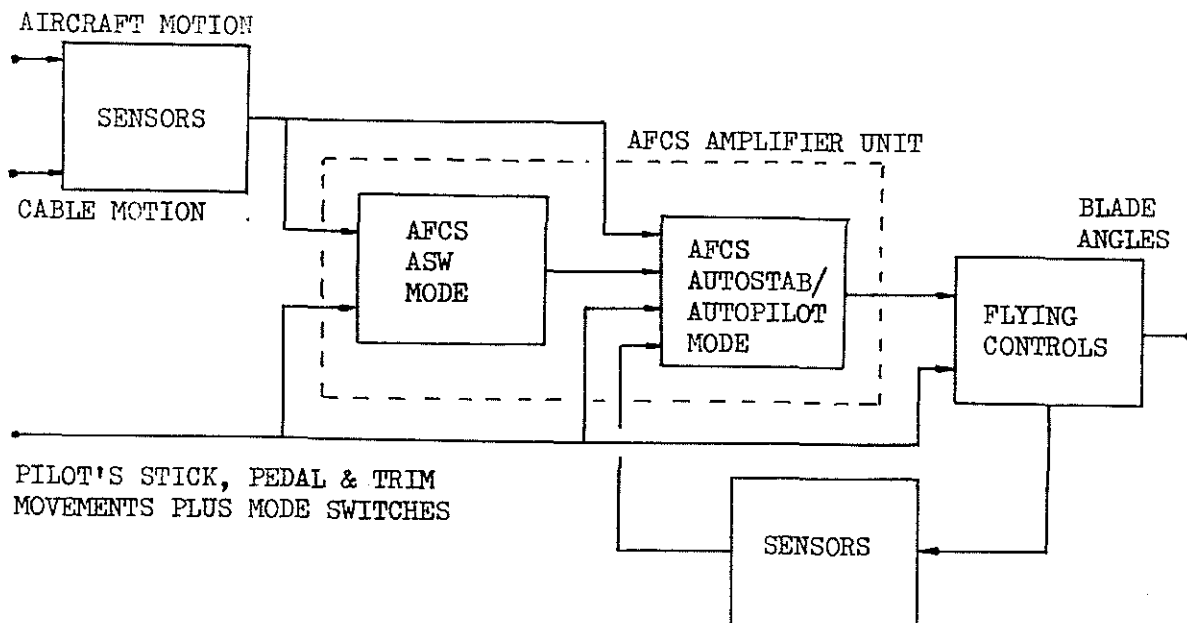

Fig 4 Control systems block diagram

When developing this part of the model, it was considered worthwhile having two versions available - 'full' and 'simplified'. The full version<sup>12-14</sup> represents the individual elements forming the aircraft system, while the simplified version<sup>15</sup> represents only the overall control laws and systems. Both are useful for different types of problem analysis.

#### 4.1 Flying Controls

The flying controls connect the pilot and AFCS inputs to the blade actuating mechanisms as shown in Fig. 5. Both the auxiliary and primary jacks provide servo assistance and the mixing unit enables collective movements to be cross-fed onto cyclic and tail rotor blade motions to enhance the handling qualities. AFCS signals are input through Moog valves in the auxiliary servo unit which comprises four jacks (fore-aft, lateral, yaw and collective), each acting as a limited-authority series actuator. In addition, the unit provides supplementary cyclic pitch control from the beeper trim system. This enables fine adjustment of the cyclic stick to be made through pilot operated trim switches and also enables extension of authority for AFCS signals to occur. In the collective and yaw channels, authority extension is provided by 'open-loop' spring operation of the auxiliary servos.

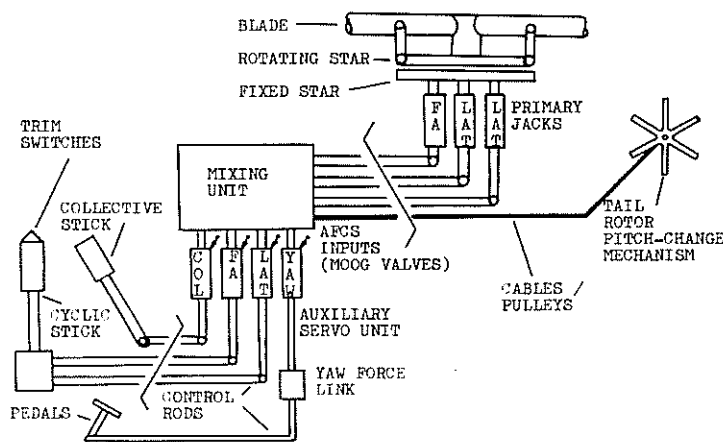

Fig 5 Aircraft flying controls

For the purpose of modelling both the full and simplified control systems, it is convenient to separate the flying controls into cyclic (fore-aft and lateral), main rotor collective, and yaw (tail rotor collective) channels. Taking the full model, each component of the flying controls in each of these channels is represented and an example of a block diagram (the fore-aft cyclic channel) is shown in Fig. 6. The block diagram is formulated using the aircraft system and the equations for the mathematical model can be derived from the diagram. Modelling of the other channels uses similar principles.



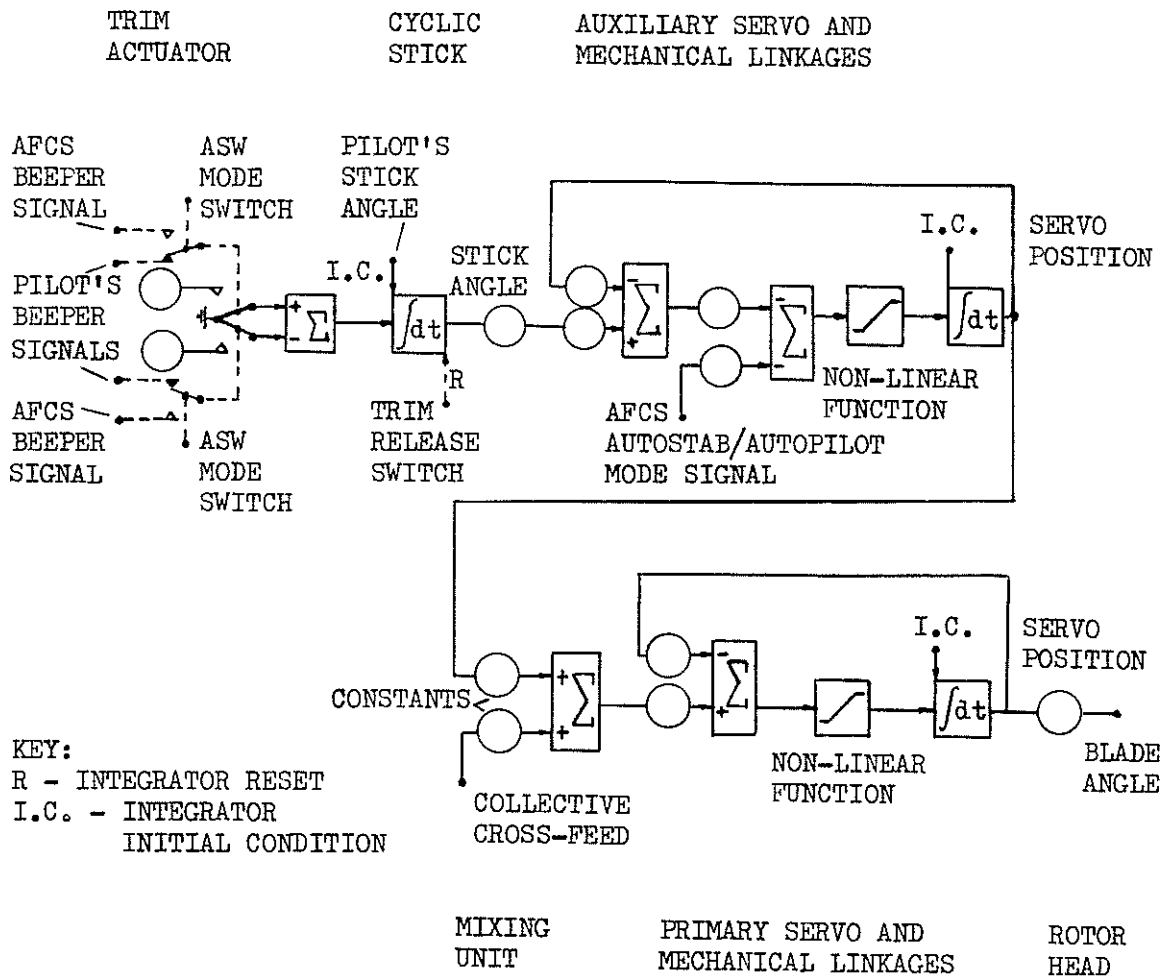

Fig 6 Fore-aft flying controls model

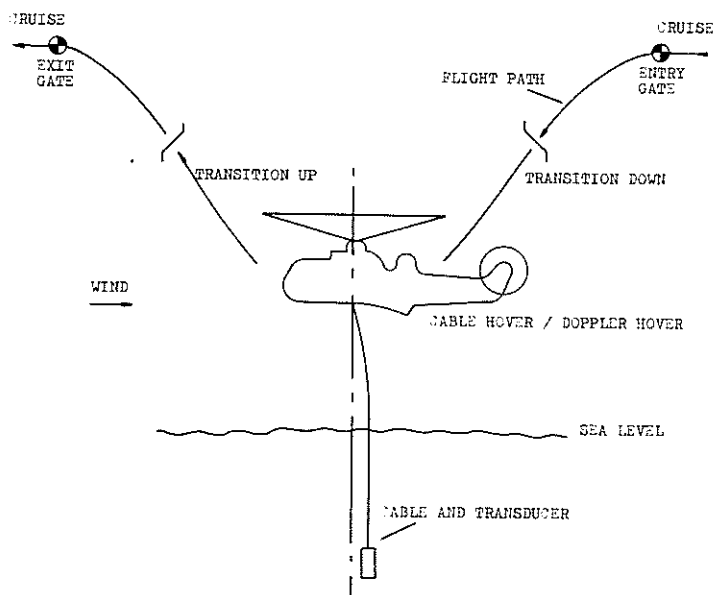

Fig 7 ASW manoeuvre

## 4.2 Automatic Flight Control System (AFCS)

An AFCS facilitates the handling of the aircraft and enables ASW manoeuvres, like that shown in Fig. 7, to be performed automatically. The control laws, which use sensor signals as inputs and operate on them to achieve the desired features, are implemented in the electronic amplifier unit (Fig. 4). The electrical signals output by the amplifier unit operate the flying controls via the auxiliary servo Moog valves.

### 4.2.1 Autostabilizer/autopilot mode

The autostabilizer functions as an attitude hold system by means of which the aircraft is stabilized at the pitch, roll and yaw attitudes established through the flying controls. Autopilot facilities are heading hold and barometric height hold.

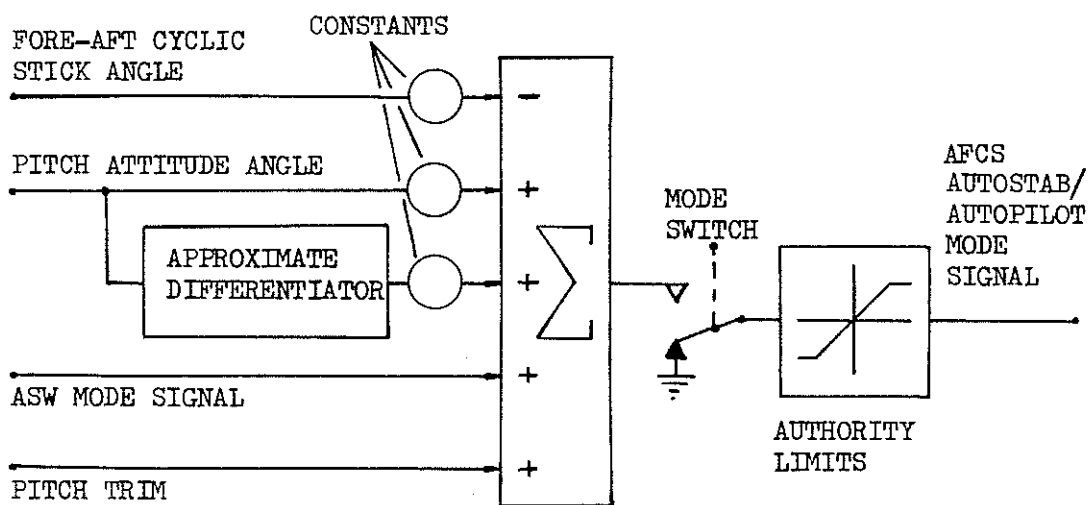

Fig 8 Pitch channel autostabilizer

To illustrate the character of the simplified model, the pitch cyclic channel is shown in Fig. 8. The attitude holding and stabilizing characteristics are achieved by the use of the pitch attitude signal supplied by the aerodynamics/kinematics model, and its approximate derivative. The roll channel modelling is similar, while the yaw channel provides both heading hold and rate damping. In the collective channel, the height datum is set when the barometric altitude hold is engaged and subsequent deviations in height are fed through the channel to stabilize the aircraft at this datum.

#### 4.2.2 ASW mode

For modelling, it is convenient to subdivide this mode into cyclic channel and radio-altitude-hold parts. The cyclic channels may be further subdivided into pitch and roll sections. In each of these, two control laws are used, one for transition, doppler hover and air-sea rescue manoeuvres (doppler mode), and the other for cable hover (cable mode).

For doppler mode control of the pitch channel, a law incorporating longitudinal groundspeed error and its integral is used. The proportional error signal is the difference between the smoothed doppler groundspeed and its reference, which is programmed to ramp from cruising speed to zero, or vice versa, over a set time period during transitions. The roll cyclic channel is similar, except that zero lateral groundspeed reference is used.

The object of cable mode control is to maintain the sonar transducer still and upright in the water. To do this in calm conditions, the aircraft's plan position is adjusted to minimize deviation in the cable angle from vertical at the aircraft. A trim control is incorporated to offset this angle for use in windy conditions, so that the aircraft can maintain a position ahead of the transducer to counteract the bowing effect of wind and sea currents on the cable. The control signal comprises the cable angle error signal, its integral, and a damping signal derived from aircraft acceleration. In addition to modelling the control laws, other features such as beeper operation are incorporated.

For radio-altitude-hold operation, level flight is maintained by setting the desired radio height and controlling the aircraft to maintain this height using radio altimeter sensing. Operation during transition manoeuvres is similar, except that the demanded height varies linearly from the aircraft's cruise altitude to the hover height, or vice versa, over a set time period.

#### 5. SONAR CABLE AND TRANSDUCER MODEL

The representation of the cable and transducer in the Sea King model is basically the same as that described in ref. 8 for the Wessex model. However, there are some errors and inadequacies apparent in ref. 8, and these are corrected in ref. 16. The model representation of the cable and transducer is shown in Fig. 9. The cable is first divided into sections (Fig. 9a) whose lengths, which may be all different, are specified by the user of the model, taking into account the desired accuracy and execution speed for a given simulation. The transducer is considered to form the lower end section. For each section, the mass is assumed concentrated at the centre of gravity. Except for the lower end section, this corresponds to the section mid-point. The point masses are then linked by weightless, rigid rods, joined sequentially to one another by frictionless pivots (Fig. 9b). Gravitational, fluid and tension forces are considered in the motion of each link (Fig. 9c) so that a set of simultaneous differential equations can be derived. Small angle approximations are used for the relative angular displacement of joined links.

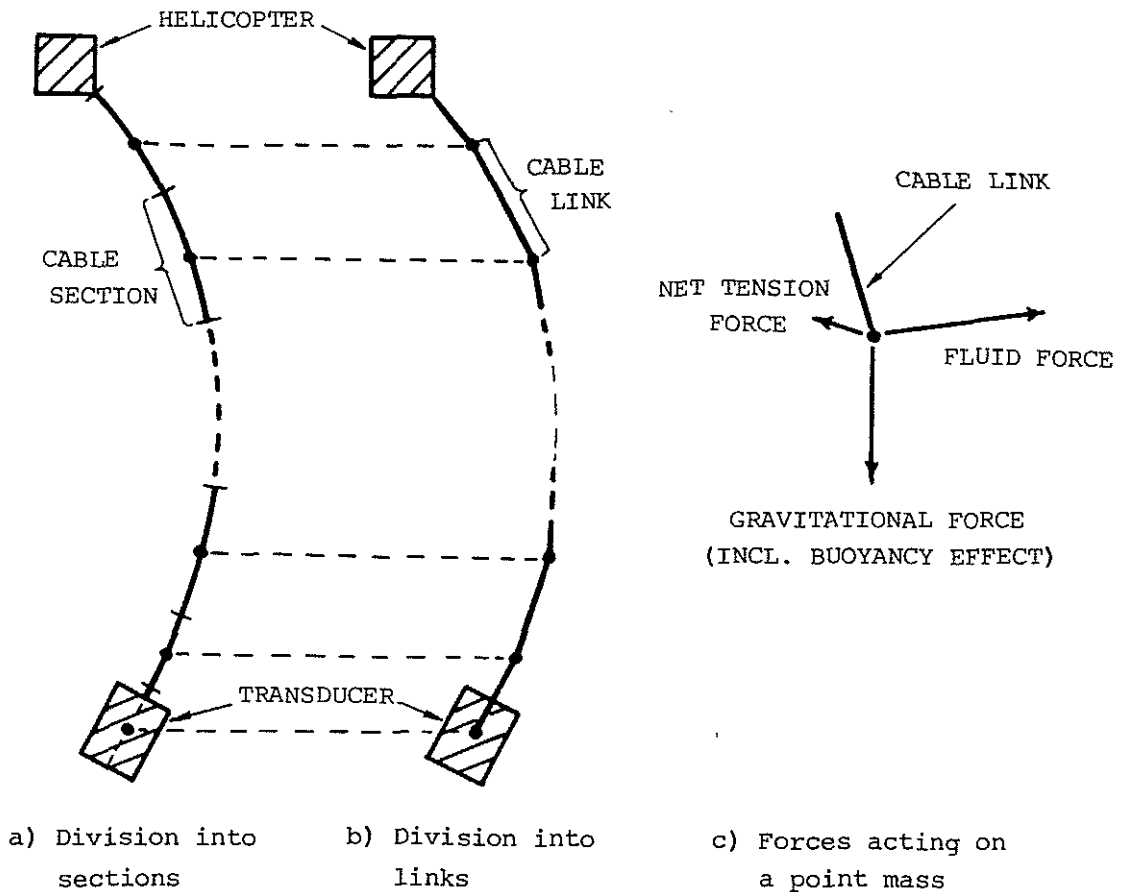

Fig 9 Model representation of the cable and transducer

Besides the modifications to the Wessex cable model mentioned above, a more accurate representation of the hydrodynamic characteristics of the transducer, embodying data from wind tunnel tests on a 0.75 scale model, has been incorporated. The tests provided aerodynamic coefficients for drag and lift forces and pitching moment as a function of Reynolds Number and angle of incidence. Examination of the results showed that variation with Reynolds Number could be ignored and that provided the direction of fluid flow deviates less than 30 deg from the lateral XY plane, drag coefficients in the lateral and longitudinal directions could be represented by constants. Since the model does not include lowering or raising of the transducer, this condition on relative fluid flow direction will be satisfied in most cases. In view of the complexity of representing pitching moment in the model and its small effect on the overall motion (i.e. generally small oscillations in transducer tilt angle), it has not been included.

Deployment of the sonar transducer and cable is made through an opening in the floor of the aircraft, known as the funnel, with the point of suspension some distance above the floor. The characteristics of this arrangement form part of the model, including the effects of cable frictional resistance on the side of the funnel. Outputs from the cable model include tension force at the suspension point (supplied to the aerodynamics/kinematics) and cable angle deviations from the vertical in pitch and roll (supplied to the control systems).

In addition to the cable link model, there have been a number of separate studies on various aspects of the cable and transducer. In each case, a number of simplifications have been possible allowing a greater insight into the effect of certain parameter changes. In one of these studies, steady-state conditions were assumed and general solutions obtained for three-dimensional motion in a non-uniform flowfield.<sup>17</sup> These solutions are applicable to the calculation of offset cable angle corrections for use in cable hover manoeuvres in windy conditions. In another study on the problem of increase in amplitude of oscillation of the transducer when winched from the sea, the cable was represented as rigid and weightless, with fluid forces neglected.<sup>18</sup>

## 6. OTHER FEATURES

### 6.1 Computer Program

The computer program for the complete model is written in CSMP-10(ARL)<sup>19</sup>, which is a block-oriented simulation language. The model is expressed in coded form with the aid of block diagrams comprising a number of linked modules, called blocks, each one representing a particular function or operation; e.g. integration and summation. The language incorporates 'user-defined' blocks, written as FORTRAN subroutines, which enable complex algebraic expressions to be handled conveniently. A large number of outputs may be defined within these subroutines by using 'user-output' blocks.

In the coding, the model is represented by three types of statements - configuration, parameter and function. The configuration statements describe the blocks used and specify the way in which they are linked together. The parameter statements specify numerical values of parameters associated with the configuration statements, such as integrator initial conditions, while function statements specify the co-ordinate pairs used to generate a function. Also incorporated in the language is an output program capable of producing graphical and tabular results in a variety of formats.

### 6.2 Sample Results

To demonstrate the performance of the model, sample results from a representative test are presented, where the model is programmed to perform the following manoeuvre:

- i Initial condition - Near steady flight at a forward velocity of 90 kn, altitude 200 ft (61 m), with autostabilizer, heading hold and radio altitude hold engaged.
- ii Transition to hover at 40 ft (12.2 m) altitude, begun at 5 s.
- iii Dunking of sonar transducer, begun at 100 s.
- iv Run terminated at 200 s.

Such a manoeuvre illustrates the performance of many parts of the model and time histories for some selected variables are shown in Fig. 10. The main features are summarised below:

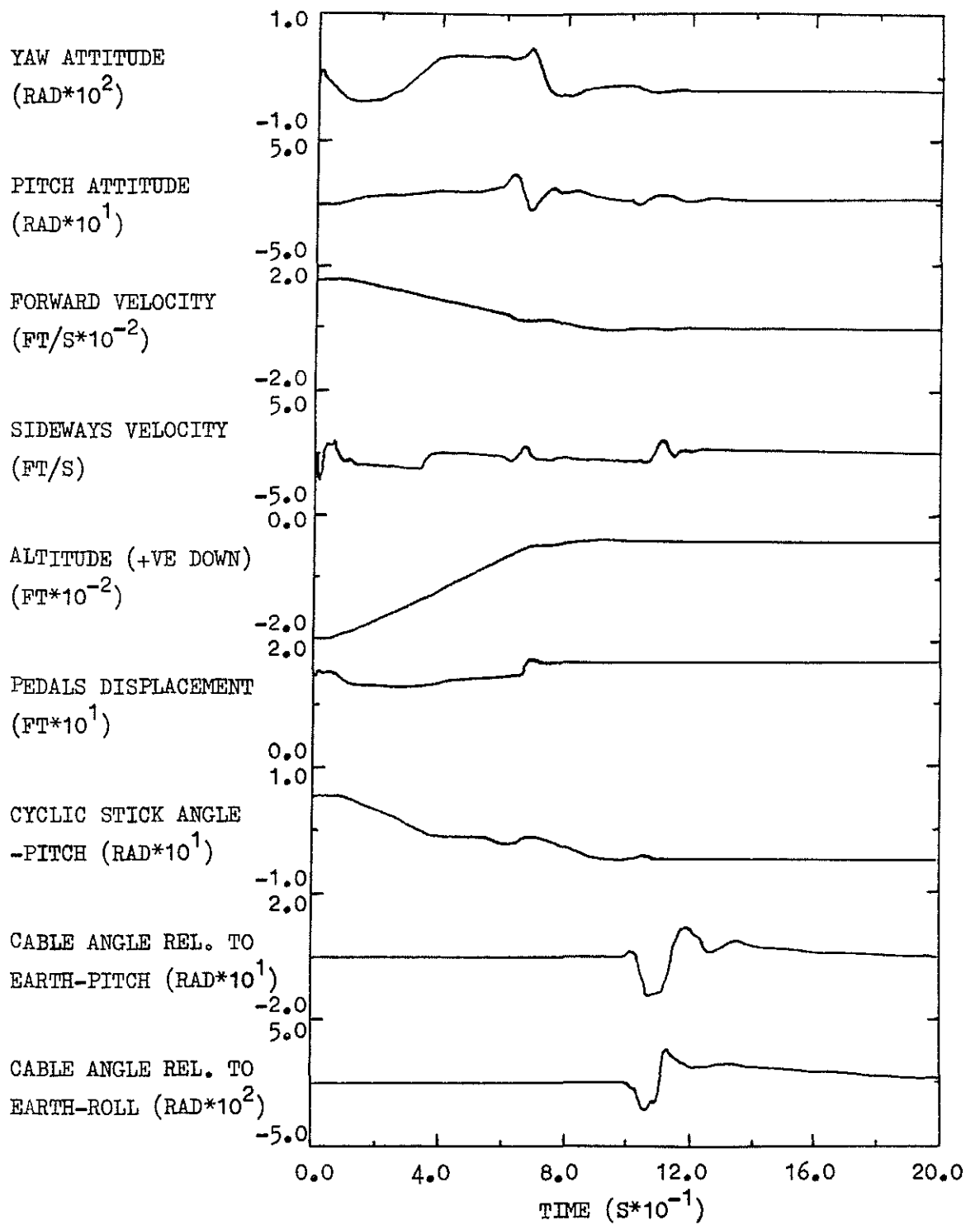

Fig 10 Time histories for selected variables

- i Overall, the aircraft performs the level flight, transition down, doppler and cable hover manoeuvres smoothly and in a reasonable manner in accordance with specifications.
- ii Initial deviations from the desired path are due to imperfect initial conditions.
- iii Automatic cyclic stick and pedal positioning occur during the run. These are examples of AFCS authority extension via the beeper and open-loop spring systems respectively.

The results shown are obtained directly from the output program which forms part of the simulation language. Note that the aircraft altitude is measured positive downwards because of the (standard) conventions used for body axes in the model.

## 7. CONCLUDING REMARKS

An aircraft/control systems/cable model of the type described here has proved suitable for investigating problems which occurred in the use, modernization and performance assessment of the Wessex helicopter. Although flight trials have been carried out to obtain a data bank for validation of the Sea King model, no comparisons of the model with flight test results have yet been made. However, in results such as the sample shown, the model is seen to behave in a reasonable manner.

When considering where the main model inadequacies may lie, it seems likely that the assumptions used in modelling the rotor are the most limiting. This arises partly because a compromise has to be struck between the amount of detail involved and the amount of computational time required to solve the relevant equations. Although the mathematical model presented here does not have to run in real time, as does a flight simulator model, computer time is still an important factor. While the blade element/actuator disc representation is reasonably frugal in this regard compared with detailed wake modelling representations, the latter may give more accurate results. However, such methods are currently impracticable if manoeuvres like transitions, where conditions are continuously changing over reasonably long time periods, are to be simulated.

The simulation language CSMP-10(ARL) has proved a viable means for programming, the language output program providing a particularly convenient means for presenting results. While this model and its computer solution is not well suited to real time operation, it enables considerable detail to be incorporated and provides good flexibility for investigating a wide range of helicopter/control system/cable problems.

## ACKNOWLEDGEMENT

The authors wish to acknowledge the contribution made by Mr. T.J. Packer to the development of the Wessex Helicopter mathematical model, from which the work described here is derived. The assistance of Westland Helicopters and Louis Newmark Ltd., for supplying control systems information, is also acknowledged.

## REFERENCES

1. T.J. Packer Wessex Helicopter/Sonar Dynamics Study: Initial Report.  
Weapons Research Establishment Tech. Note SAD 216 (1969).
2. C.R. Guy Wessex Modernization: A Preliminary Simulation Study.  
Aeronautical Research Laboratories Aero. Note 391 (1979).
3. T. Wilcock A Piloted Flight Simulation of the Westland Lynx.  
Royal Aircraft Establishment Tech. Report 74099 (1974).
4. E.E. Austin and W.D. Vann General Description of the Rotorcraft Flight Simulation Computer Program (C-81).  
USAAMRDL Tech. Note 11 (1973).
5. H. Collomosse All Weather Operation for Helicopters: Flight Control Systems for Helicopters.  
J. Royal Aero. Soc. (1969), 73, 129-137.
6. K.S. Snelling and M.V. Cook Some Aspects of the Design and Development of the Maritime Autopilot Modes for the Westland Lynx Helicopter.  
AGARD-CP-258 (1979), paper 5.
7. T.J. Packer Wessex Helicopter/Sonar Dynamics Study: The Mathematical Model of the Helicopter Aerodynamics and Kinematics.  
Weapons Research Establishment Tech. Memo. SAD 203 (1969).
8. T.J. Packer Wessex Helicopter/Sonar Dynamics Study: The Mathematical Model of the Sonar Cable and Transducer.  
Weapons Research Establishment WRE-Report-951 (W.R. & D.) (1973).
9. T.J. Packer and R.C. Lane Wessex Helicopter/Sonar Dynamics Study: The Systems Simulation Program.  
Weapons Research Establishment Tech. Note WRE-TN-937.  
(W.R. & D.) (1973).
10. C.R. Guy and M.J. Williams Selected Flight Test Results from a Sea King Mk. 50 Helicopter.  
Aeronautical Research Laboratories Aero. Note to be Published.
11. - Mathematical Model for the Simulation of the Sea King Mk. 50 Helicopter.  
Westland Helicopters Ltd. Tech. Note FM/SK/001 (1974).



12. C.R. Guy                    Sea King Mk. 50 Helicopter Flight Control System:  
A Mathematical Model of the Flying Controls.  
Aeronautical Research Laboratories Aero. Note 388  
(1979).
  
13. C.R. Guy                    Sea King Mk. 50 Helicopter Flight Control System:  
A Mathematical Model of the AFCS (Autostabilizer/  
Autopilot Mode).  
Aeronautical Research Laboratories Aero. Note 387  
(1979).
  
14. C.R. Guy                    Sea King Mk. 50 Helicopter Flight Control System:  
A Mathematical Model of the AFCS (ASW Mode).  
Aeronautical Research Laboratories Aero. Note 393  
(1979).
  
15. C.R. Guy                    Sea King Mk. 50 Helicopter/Sonar Dynamics Study:  
A Simplified Control Systems Mathematical Model.  
Aeronautical Research Laboratories Aero. Report 152  
(1979).
  
16. N.V. Williams,  
C.R. Guy,  
M.J. Williams  
and N.E. Gilbert                Wessex Helicopter/Sonar Dynamics Study: ARL Program  
Description and Operation.  
Aeronautical Research Laboratories Aero. Note 385  
(1979).
  
17. N.E. Gilbert                Steady State Behaviour of a Cable Used for Suspending  
a Sonar Body from a Helicopter.  
Aeronautical Research Laboratories Aero. Report 149  
(1978).
  
18. N.E. Gilbert                Reduction in Swing of a Sonar Body Winched from the  
Sea by a Helicopter.  
Aeronautical Research Laboratories Aero. Note 395  
(1979).
  
19. N.E. Gilbert                An Extended Version of CSMP-10.  
and P.G. Nankivell              Simulation (1977), 29, 60-61.