

**NINETEENTH EUROPEAN ROTORCRAFT FORUM**

Paper No. L1

**AH-64D OPERATIONAL EMPLOYMENT AND EFFECTIVENESS MODELING**

by

**HUGH DIMMERY**

**McDONNELL DOUGLAS HELICOPTER COMPANY**

September 14-16, 1993  
CERNOBBIO (Como)  
ITALY

**ASSOCIAZIONE INDUSTRIE AEROSPAZIALI  
ASSOCIAZIONE ITALIANA DI AERONAUTICA ED ASTRONAUTICA**



# AH-64D OPERATIONAL EMPLOYMENT AND EFFECTIVENESS MODELING\*

Hugh Dimmery  
McDonnell Douglas Helicopter Company  
Mesa, Arizona

## Abstract

The AH-64D Longbow represents a significant enhancement in attack helicopter capability that provides the commander the means to prosecute the modern battlefield tenets of agility, initiative, depth, and synchronization. These capabilities, however, require the utilization of new concepts, tactics, and techniques to realize the maximum potential the AH-64D Longbow brings to the battlefield.

This paper examines some of the AH-64D Longbow capabilities and inherent design features that enhance situational awareness, facilitate attack coordination, and expand the target servicing options. These inherent capabilities provide the means for future commanders to execute the requirements of the modern battlefield: Project power, protect the force, win the information war, conduct precision strikes, and dominate the maneuver battle. Additionally, this paper examines some of the operational effectiveness modeling challenges experienced at McDonnell Douglas Helicopter Company and addresses some of the solutions put forward in the evaluation of this advanced weapon system.

## Introduction

The initial fielding of the AH-64A Apache placed the burden of developing tactics, techniques, and operational employment concepts on the initial units. This experience, combined with the extensive increase in capability, has led to a concurrent development approach that considers

the tactics, techniques, and procedures during the design and development process. A team of U.S. Army pilots, McDonnell Douglas Helicopter Company pilots, system design engineers, and operational effectiveness analysts has jointly developed the design features that enable the crew to effectively and efficiently operate the system while accommodating the operational employment considerations.

The AH-64D Longbow represents a significant enhancement in war-fighting capability that will provide the commander an enormous tactical advantage throughout the depth and breadth of the modern battlefield. Its expanded sensor package with extended range, adverse weather capability, and multimissile fire-and-forget capability provide a significant enhancement to the overall lethality and survivability of the total weapon system. These capabilities coupled with the ability to share information, in near real time, via the improved data modem (IDM) will enhance situational awareness and expand the target engagement options. This near-real-time data-sharing capability provides the means for the combined arms team to win the information battle at the tactical level, swiftly mass to conduct highly coordinated attacks, and dominate the maneuver battle. However, to capitalize on these improvements and leverage the importance of the AH-64D to the combined arms team, improved attack coordination measures have been required. To illustrate some of the capability the AH-64D brings to the modern digitized battlefield, improvements in situational awareness, attack coordination requirements, and target servicing options will be addressed.

---

\*Presented at the American Helicopter Society 49th Annual Forum, St. Louis, Missouri, May 19-21, 1993, Copyright 1993 by the American Helicopter Society, Inc. All rights reserved.

### Situational Awareness

The improvements in situational awareness result from the addition of the fire control radar (FCR), the ability to display FCR information in relation to other operational graphics, and the ability to rapidly share information through the IDM.

#### *"See" the Battlefield*

The fire control radar (FCR) provides the capability to "see" the battlefield. It can rapidly scan enormous sectors of the battlefield, seeing through smoke, fog, rain, and battlefield obscuration, while detecting, classifying, and prioritizing stationary and moving targets. This capability is essential for operations in adverse weather but is equally important in good weather. The ability to "see" the battlefield is fundamental to maintaining situational awareness of the tactical environment.

#### *Early Warning Provides Freedom of Maneuvers*

The FCR incorporates a ground targeting mode (GTM), an air targeting mode (ATM), and a terrain profile mode (TPM). In the targeting modes

the FCR can be positioned at any angle relative to the helicopter. Variable scan sizes in each mode provide a 360-degree early warning and target acquisition capability. This all-around security, early warning, and target acquisition capability provides the situational awareness that enables proactive mission management. Figure 1 provides an illustration of an attack team using the FCR during the ingress phase of a mission. Team security tasks have been distributed among the team members to ensure both air and ground searches are being conducted. In this example, the team leader is employing the FCR in the ATM while other team members are providing sector security by employing the system in the GTM. Employing the system in this manner provides a proactive mission capability that enables the team to respond to encounters with the appropriate course of action while retaining freedom of maneuver. Not only can the FCR be employed to provide early warning and situational updates, it can also be used to confirm premission planning information and aid pilotage in adverse conditions.

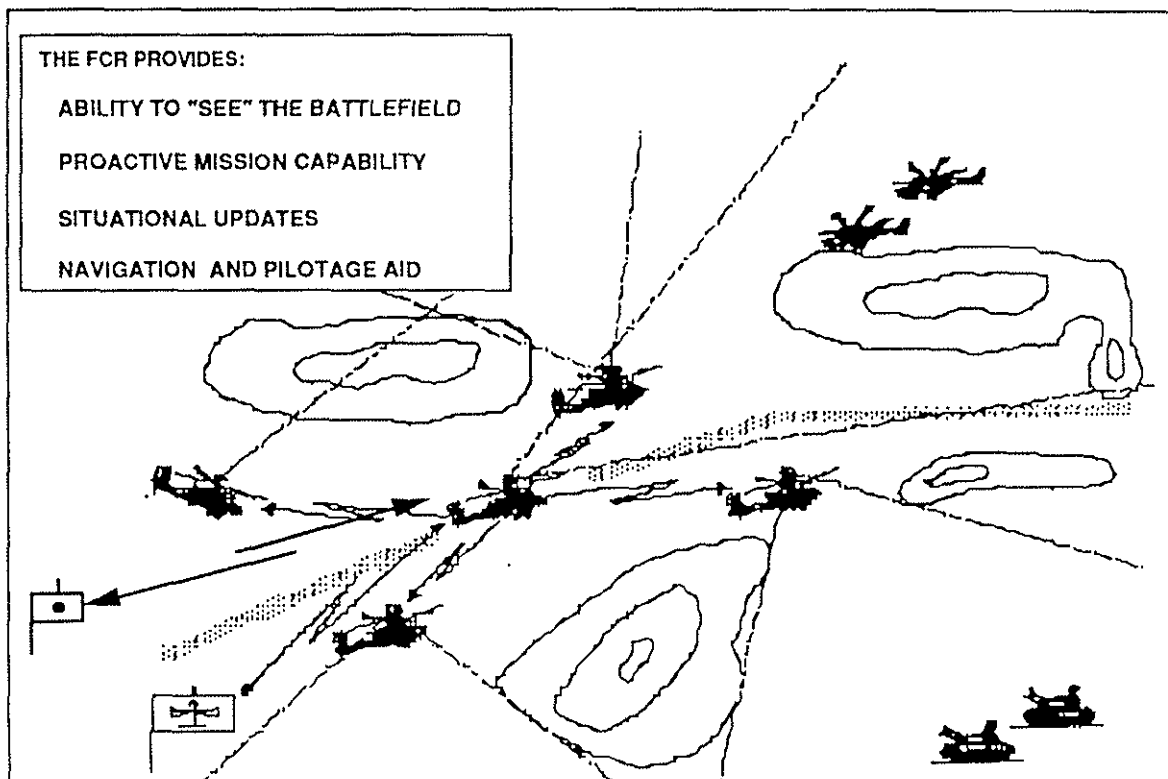

Figure 1. Situational Awareness

Unexpected encounters with the enemy are almost eliminated by the long-range, adverse weather, early warning capability of the FCR. This capability turns most unexpected encounters into less critical unanticipated encounters. Unanticipated encounters are defined as detecting the enemy at unplanned locations but at ranges sufficient to permit freedom of maneuver. Although limited, unexpected encounters would still occur in situations where the enemy is masked from radar detection. As an example, an AH-64D flight paralleling a ridge would not detect an air defense unit on the opposite side of the ridge until the team emerged from behind the masking terrain. In this case, the long-range early warning capability is not as significant as the totally integrated, rapid engagement capability. The design enables the FCR and the radio frequency interferometer (RFI), operating together, to provide an immediate air defense suppression capability. This function, which is referred to as a cued search capability, rapidly combines RFI signals information with FCR information and identifies the emitting air defense unit as the highest priority target for engagement.

### Displaying FCR Information

Figure 2 provides a representation of the displays and the information available to each crewmember. The left display shows the results of an FCR scan in the GTM, radar map format. The right display is the tactical situation display (TSD), and the picture in the bottom center represents the image being viewed on helmet-mounted display (HMD) or the target acquisition and designation sight (TADS) display. Employing the FCR in the wide scan width provides a picture of the battlefield in relation to planned operational graphics and control measures. Every potential target the FCR detects and those prioritized for engagement are presented to the crew.

The top-priority targets are represented by target symbology on the FCR display and the total number of targets are indicated by the figure in the upper left corner of the display. The diamond symbol indicates the highest priority or next-to-shoot (NTS) target and the cursor symbol represents the second target in the priority sequence. On the TSD, all detected targets are displayed, along with the

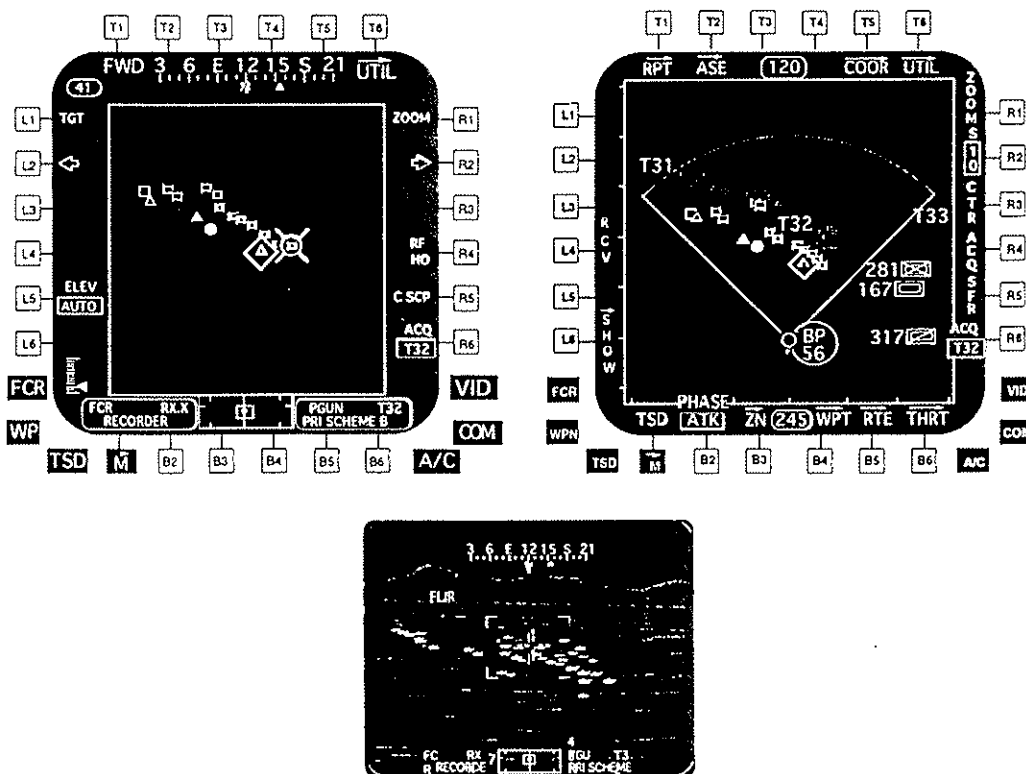

Figure 2. "See" the Battlefield

FCR footprint, indicating the area covered. Environmental conditions permitting, the electro-optical sensor, TADS, can be linked to the FCR and automatically orient on the NTS target in the narrower fields of view. This capability is particularly useful when targets must be positively identified prior to engagement.

*Sharing FCR Target Data*

Although the FCR provides the means to collect information over a wide area of the battlefield, the IDM is the lifeline to improved awareness and situational assessment. The FCR provides a broad area relational picture of the battlefield which serves to enhance individual awareness and improve survivability. But the real value of increased tactical information is realized through the capability to share FCR target data with any team member or command element. Sharing FCR target data is conducted by utilizing the report function (upper left button labeled RPT) on the TSD (figure 3).

The report function accommodates the selection and transmission of individual, all, or priority ("PRI") FCR targets. It provides the capability to extend the area of increased situational awareness and provides an accurate means to cue sensors. Sharing information for immediate engagement is referred to as radio frequency (RF) handover and will be covered in the target servicing section. FCR target data, when shared with other team members, commanders, and other combined arms elements, provides a near-real-time situational assessment capability that increases operational effectiveness throughout the depth and breadth of the battlefield.

*Situational Awareness Summary*

Simply stated, enhanced situational awareness is a result of the ability to "see" the battlefield with the FCR and communicate what is seen with the IDM. This real-time sharing of battlefield information enables proactive mission management, provides superior tactical awareness, provides immediate input to the intelligence

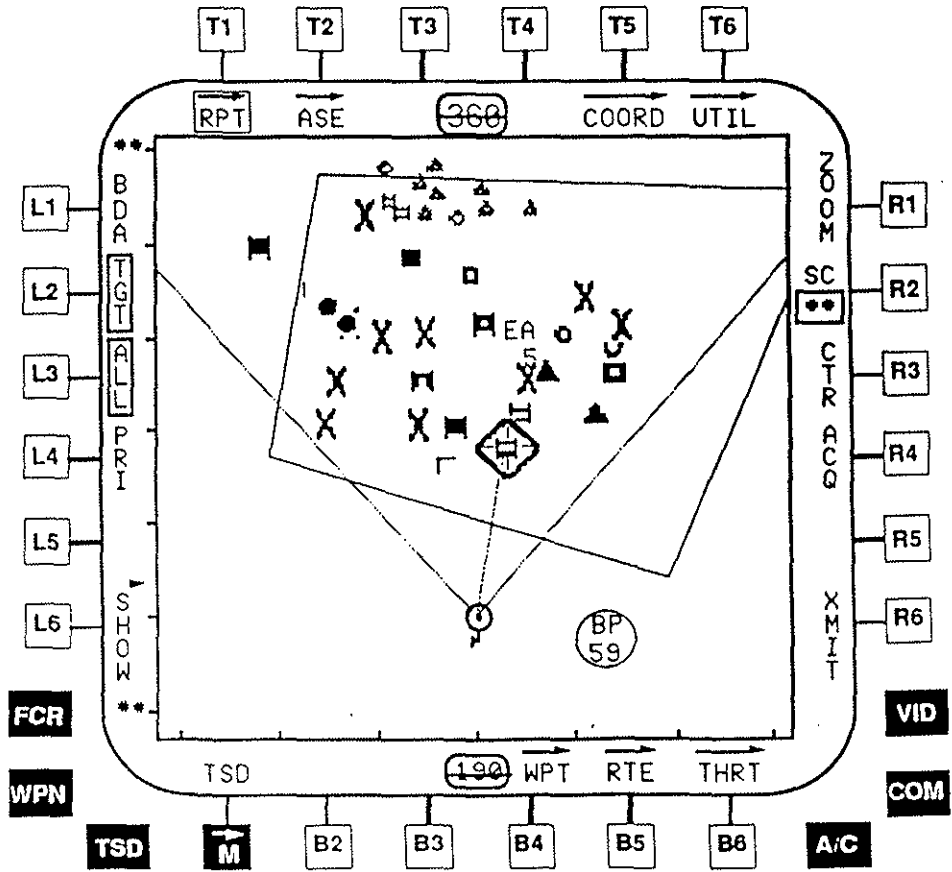

Figure 3. Sharing FCR Target Data

process, and enables commanders to conduct real-time situational assessments. On the battlefield of the future, the AH-64D's ability to rapidly collect information over vast areas and quickly pass that information to commanders and operations centers will ensure U.S. forces have an information advantage on the modern battlefield. As discussed later, this capability to "see" the battlefield and distribute the information is also essential to effective command and control of modernized Apache attacks.

Attack Coordination

Attack coordination (fire distribution and control) takes on added significance when employing fire-and-forget missiles beyond electro-optical acquisition ranges. Attack coordination for the modernized Apache must be viewed in terms of precise areas of engagement as opposed to the traditional view of handing over specific targets or engaging the array by Standard Operating Procedures, e.g., left shoots left, etc. Without additional control measures, autonomous engagements by more than one AH-64D Longbow will result in multiple kills of the same target.

Early operational effectiveness analyses, although extremely favorable, demonstrate the impact of not employing adequate attack coordination techniques. Figure 4 is a representation of early operational effectiveness results in which the

AH-64D Longbow teams were employed using traditional fire distributions and control techniques. In this example, total missiles fired are compared to the number of hits and the number of kills. As can be seen, there is a great disparity between hits and kills which is directly attributable to the lack of adequate attack coordination measures. Without specific areas of engagement for each team member, the potential for multiple hits on the same target is extremely high.

Figure 5 illustrates the overlap in FCR coverage that creates the overkill potential if traditional fire distribution is employed.

In this example, three AH-64D Longbows are occupying a battle position with 400-meter separation. An armor column is detected moving southwest along a road between engagement area one (EA 1) and engagement area two (EA 2). If each team member orients the FCR to the center of the target array, the overlap in radar scans results in essentially the same targets being prioritized and engaged by each aircraft.

As a result, new methods of attack coordination are required to control and distribute the fires of the modernized Apache team. To achieve maximum system effectiveness, modernized Apaches will precisely divide the battlefield among the team members prior to engagement. To accomplish this, the team leader must "see" the battlefield as explained in the previous section. Once the

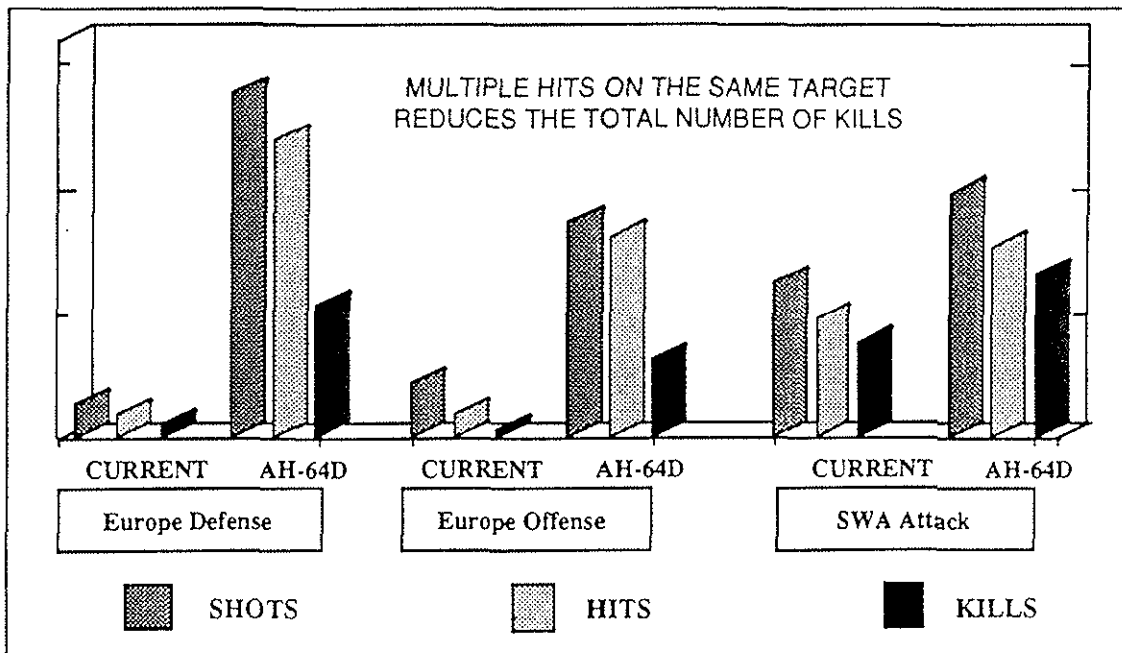

Figure 4. Improper Attack Coordination Impact

target array is pictured in relation to known graphics and control measures, the team leader must determine and distribute the attack plan. Attack coordination for the modernized Apache is done through the establishment of specific zones.

*Precise Areas of Engagement*

The zone (ZN) function is located on the tactical situation display (TSD) and is readily available. It provides the essential options for distributing the team fires, preventing multiple hits on the same target, and minimizing fratricide potential. The no-fire (NF) zone function establishes an area in which the FCR will not prioritize targets for engagement. This capability prevents unintentional engagement of friendly units. Once established, no-fire zones can be transmitted to the team by the IDM. Upon receipt, the zone is automatically passed to the FCR and serves to preclude the prioritization of targets within the zone for each team member.

Conversely, priority fire (PF) zones provide precise areas of engagement for each team member. The precise division of the battlefield prevents multiple engagements of the same target, distributes the team's fire equally across the array, and further minimizes the potential of fratricide. The three methods of establishing priority fire zone – (1) automatic, (2) manual, and (3) target reference point – have been designed to accommodate variations in target density and dispersal. Once developed, the entire attack plan is distributed to the team. Upon receipt, specifically assigned zones are highlighted and automatically passed to the FCR to create an area in which targets will be prioritized above all others.

Figure 6 provides an illustration of a completed attack plan. The no-fire zone has been positioned to protect a friendly reconnaissance unit north of battle position (BP) 56. Priority fire zones have been established and designated for specific team members. The bold outlined zone entitled OWN is designated for the initiating aircraft.

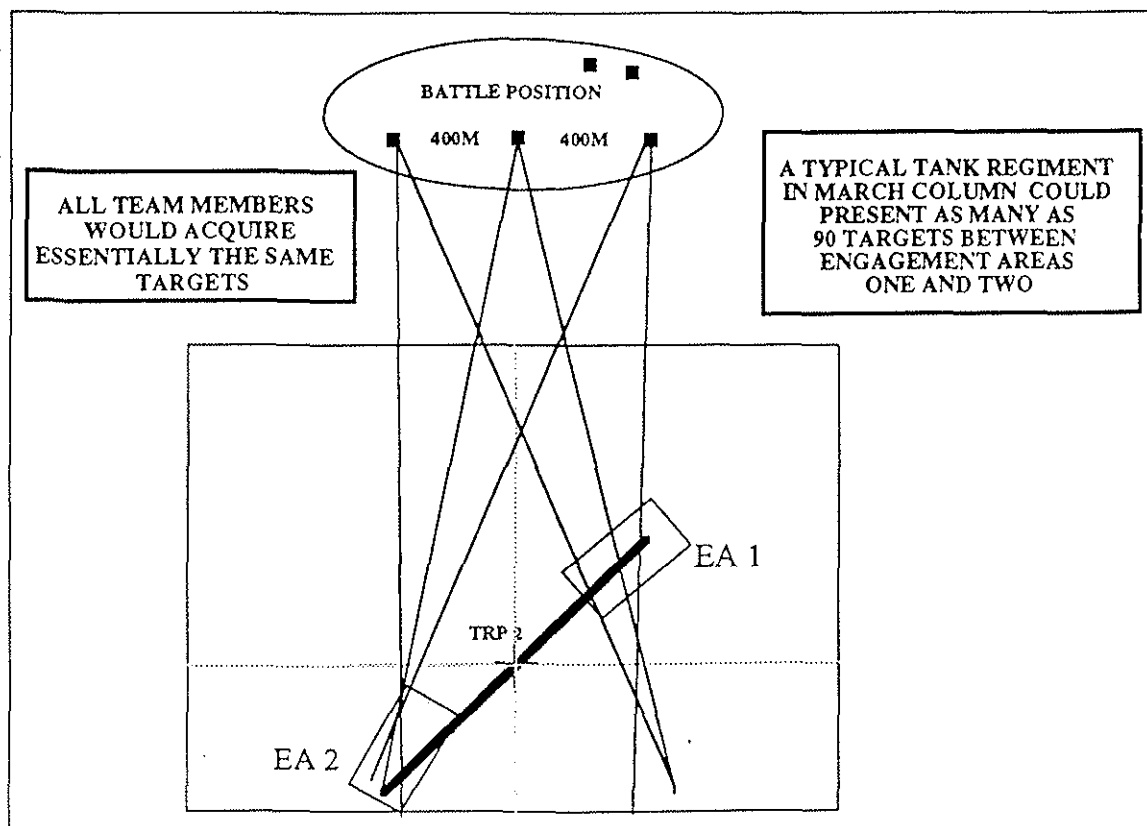

Figure 5. FCR Team Targeting



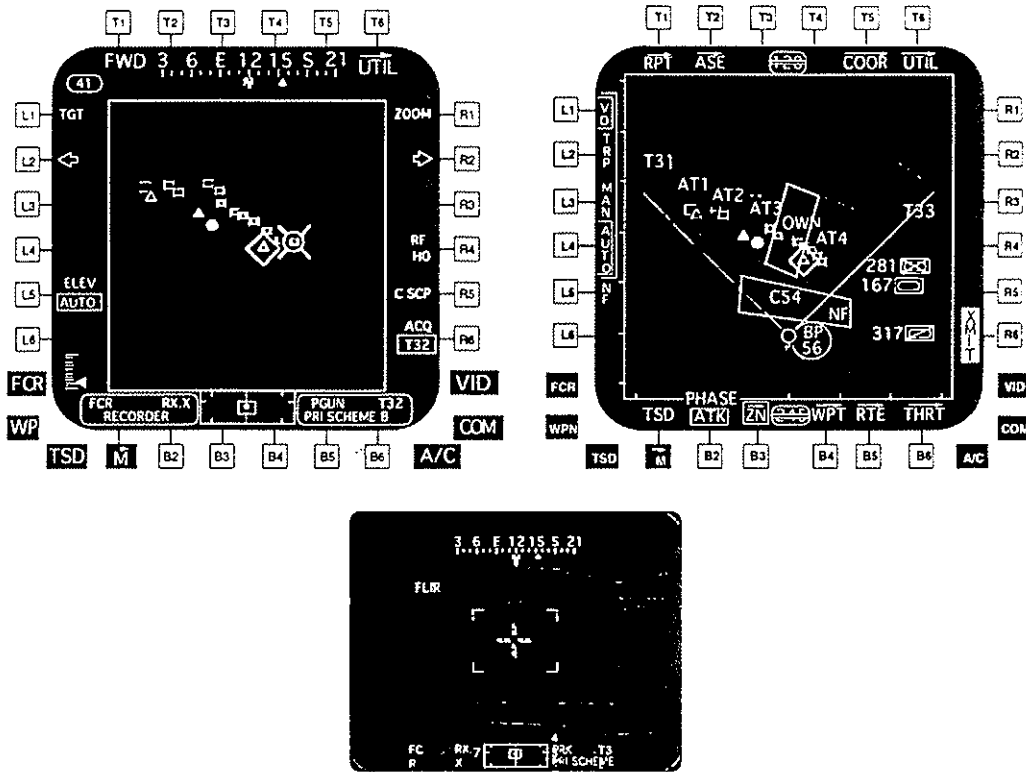

Figure 6. Completed and Assigned Attack Plan

#### Other Attack Coordination Requirements

In addition to a specific area of engagement, two other pieces of information may be required to fully coordinate an AH-64D Longbow attack: (1) target identification criteria and (2) specific tasks. In some cases the tactical situation may require the positive identification of targets prior to engagement. This criteria precludes the utilization of the Longbow system without TADS augmentation. When precise designation of engagement areas is not sufficient to isolate the enemy, the AH-64D Longbow can rapidly and accurately align the TADS to the FCR-designated next-to-shoot target. In the copilot/gunner (CPG) station, TADS video can be displayed on the head-out display (HOD) while FCR target data is simultaneously displayed on the multifunction display. This enables the CPG to conduct engagements where target identification is required by merely glancing at the HOD, identifying the target, and engaging the NTS. This integrated capability provides the crew all the essential information at one time to conduct FCR-directed RF missile engagements when target identification is required.

Task assignment is generally considered when the situation calls for a specific role to be performed by a specific team member. For example, in some situations it may be appropriate for one team member to provide aerial overwatch for the remainder of the team. Multiple prioritization tables provide the flexibility to assign more than one team member to the same zone. By employing different prioritization tables, each team member could engage separate targets within the same zone and still ensure effective fire distribution and control.

#### Attack Coordination Summary

Without attack coordination, autonomous engagement of targets in a designated area by more than one AH-64D Longbow would waste valuable Hellfire missiles and be ineffective. Specific areas of engagement prevent multiple engagements of the same target, ensure equally distributed fires across the array, and serve to minimize the potential of fratricide.

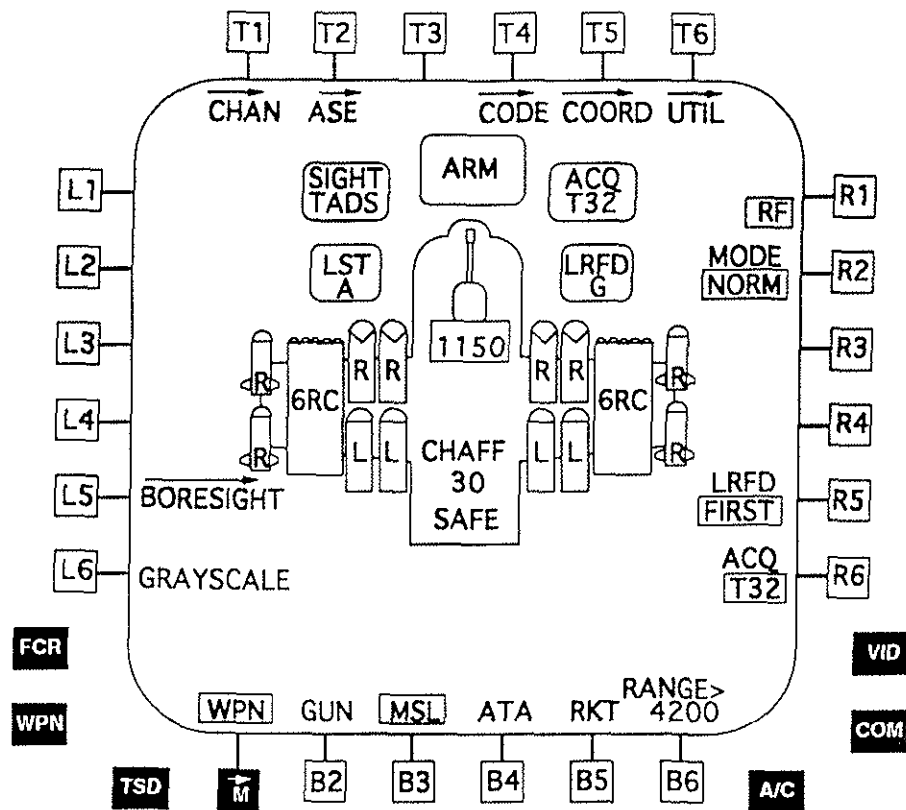

Figure 7. Weapons Page

The priority fire zones, the no-fire zones, and the target array, once transmitted, establish visual representation of the attack plan. When this is combined with the target identification criteria and any special tasks, a well coordinated and controlled attack is assured. When required, these attack coordination measures can be employed to synchronize and control the fires of other combined arms team members. This capability enhances the ability of future commanders to rapidly mass, execute violent attacks, and dominate the maneuver battle.

Targeting Servicing

Once the team has received the attack plan, several engagement techniques, team and individual, are available to the modernized Apache team. The AH-64D Longbow brings an extensive array of sensors and weapons to the battlefield. The ability to engage multiple targets simultaneously, to utilize multiple schemes for target prioritization, and to employ multiple fire distribution methods expands the target engagement options. This inherent system flexibility complicates the problem of determining the best employment option for any given set of circumstances.

*Independent Weapon System Controls*

The weapons page (figure 7) provides a graphic representation of the weapon system and illustrates the multiweapon capability. In this example, four air-to-air missiles are mounted on the wingtips, two 19-shot, 2.75 FFAR pods are mounted on the outboard pylons, and eight Hellfire missiles are mounted on the inboard pylons. A combination of semiactive laser (SAL) Hellfire missiles (indicated by the dome seeker) and radio frequency (RF) Hellfire missiles (indicated by the "V" seeker) is loaded in the launchers.

Weapon system controls are completely independent and except for the SAL Hellfire, which is dependent upon the TADS for the laser designation, any weapon can be employed by either crew-member. Additionally, except for the SAL Hellfire, any weapon can be employed with either the FCR or the TADS as the sight. Flexibility is provided by using the integrated helmet and display sight system (IHADSS) to employ self-protection and area weapons. This completely independent design allows maximum crew flexibility in selecting the sight and weapon combination most appropriate to the situation.

*Sight and Weapon Combinations.*

Multiple sensors, multiple weapons, and total integration provide a variety of employment options depending upon the mission, individual roles, and other considerations. The FCR has been totally integrated and serves as an additional sight on the AH-64D Longbow. The system permits the FCR and TADS to be operated simultaneously either independently or cooperatively by either crewmember. For example, the pilot could employ the FCR in the ATM to provide local security while the CPG engages ground targets using the TADS. The variety of employment options is further expanded by the multiple modes associated with the FCR. In addition to the ATM and the GTM mentioned earlier, the FCR can be operated in a single scan or continuous scan mode with targeting information being displayed in multiple formats. Further, the FCR and TADS can be linked. When the TADS is linked to the FCR, it automatically centers on the FCR-designated target. When the FCR is linked to the TADS, it follows the TADS line of sight, ready for immediate activation. Additional features include the capability to overlay FCR target symbology on the IHADSS or the TADS imagery.

Although the Longbow system provides a multitarget engagement capability for RF missiles, it also provides significant enhancement to the rapid

employment of all available weapons. Once the FCR detects, classifies, and prioritizes targets, weapon selection is up to the crew. In this manner, the FCR can be used to rapidly acquire targets and simultaneously provide targeting information to any weapon (30mm, 2.75-inch rockets, Hellfire missiles, air-to-air missiles). Weapon and sensor combinations available to the AH-64D Longbow crew are listed in table 1.

*Engagement Techniques*

The employment of the AH-64D Longbow in the normal mode (FCR and RF missiles) is by definition an autonomous acquisition and engagement. However, in order to optimize team effectiveness, each team member must be assigned a specific zone as explained in the previous section. Although both the TADS and the FCR can be employed to acquire targets, the automation, speed of acquisition, target prioritization, and multitarget capability make the FCR the preferred system for initial target acquisition.

The rapid acquisition capability combined with the integrated sensor suite significantly improves the engagement timelines of all potential weapons. Accordingly, employing the initial acquisition sight and then selecting the appropriate weapon for engagement is the preferred technique.

Table 1. AH-64D, Sight and Weapons Combination

Sight Type	FCR		FCR Link TADS		TADS (Link FCR)			IHADSS
	ATM	GTM	ATM	GTM	FLIR	TV	DVO	
RF Hellfire	A	P	P	P	A	A	A	X
SAL Hellfire	X	X	P	P	A	A	A	X
ATA missile	O	O	P	P	A	A	A	A
2.75-inch rocket	X	A	P	P	A	A	A	O
30 mm cannon	X	A	O	P	A	A	A	P
<u>Employment Consideration</u>				<u>Other Variables</u>				
P Primary consideration				FOV/scan size				
A Alternate consideration				FCR mode				
O Optional consideration				Scan type				
X Not recommended				Display options				
				Mission/role requirements				

Normal engagements are generally conducted from standoff ranges outside of the enemy engagement envelope. Standoff range must be evaluated in terms of environmental conditions as well as effective weapon engagement range. However, when standoff range is insufficient to preclude enemy engagement, FCR acquisition and RF missile engagement timelines are sufficiently quick to enable the AH-64D Longbow to operate well within the threat engagement envelope.

A remote engagement is defined as launching a missile at a target acquired by a remote sensor. A remote RF missile engagement involves the handover of a specific target from the AH-64D to another modernized Apache (AH-64C or AH-64D). The RF handover is conducted from the FCR page. It provides the capability to send FCR targeting information to a team member for direct assignment to an RF missile. Once received, the target may be engaged using a variety of methods, including immediate launch from defilade, depending upon the target location and state. This remote engagement capability further enhances team survivability.

#### Operational Effectiveness Impact

The advantage gained from the ability to acquire and share information is difficult to quantify in combat modeling. The areas affected by improved information such as accurate fire distribution, prioritized targets (early removal of air defense units), reduced exposure timelines, selective engagement of high-value targets, and proactive response to unexpected encounters can be incrementally examined. But the cumulative value of timely information from a total system perspective has been difficult to quantitatively assess.

The advanced weapons, sensors, and tactics employed by the AH-64D Longbow make it difficult to compare effectiveness results with other attack helicopters on a similar capability level. To conduct an even comparison, the AH-64D Longbow must be penalized to accommodate those capabilities common to current attack helicopters. This approach levels the analysis but addresses only a small portion of the AH-64D Longbow capability. The multimissile, multitarget capabilities are lost and contributions to force effectiveness are not even considered. This problem becomes most apparent when specific encounter results are compared. In most cases, the enhanced capabilities of the AH-64D Longbow provide measures that appear inordinately high in comparison to conventional attack helicopters.

Regardless of the approach, the rapid, multitarget, multisensor engagement capability has created a need to improve our modeling capability and associated measures of effectiveness (MOEs). For example, in a typical engagement, five Longbow Apaches could have a complete ordinance load in flight to individually designated targets and be departing the battle position in the time it takes conventional attack helicopters to engage one or two targets. This increased target servicing rate led to using kills per unit time instead of total kills as an appropriate MOE. Figure 8 is an extract from a comparative analysis of Apache variants which uses this MOE to compare the kill productivity of the AH-64D Longbow to that of conventional attack helicopters.

*The weapons and sensor combinations available to the AH-64D Longbow crew provide a significant number of options for consideration in analyzing total system effectiveness. In most cases, it is not feasible to examine all of the possible combinations for each specific engagement. Therefore, the sensor and weapons combinations must be prioritized as a function of mission type. Matching the weapons load to the mission also serves to limit the analysis options.*

Another area of significance is the use of the traditional system loss exchange ratio (SLER) as an MOE. Numerous analyses have resulted in no AH-64D Longbow losses. In these cases, the SLER (red losses divided by blue losses) approaches infinity as blue losses approach zero. Accordingly, alternate methods of relating comparative system effectiveness have been explored. Some of the MOEs currently employed are the Simplex Method, Survivability Ratios, Force Ratio Deltas, and Kill Productivity.

The capability to prioritize and classify targets using a variety of schemes is often overlooked when considering typical measures such as total number of targets killed. In some cases, as indicated in figure 9, non-radar-equipped Apaches were able to achieve a greater number of kills than the AH-64D Longbow. On closer inspection, however, the greater number was attributable to shooting a larger percentage of low-value targets (BMPs, trucks, etc.). The AH-64D, however, killed a greater number of high-value targets (tanks, air defense systems, etc.). As a solution, the target type as well as target value was considered in the evaluation of combat effectiveness.

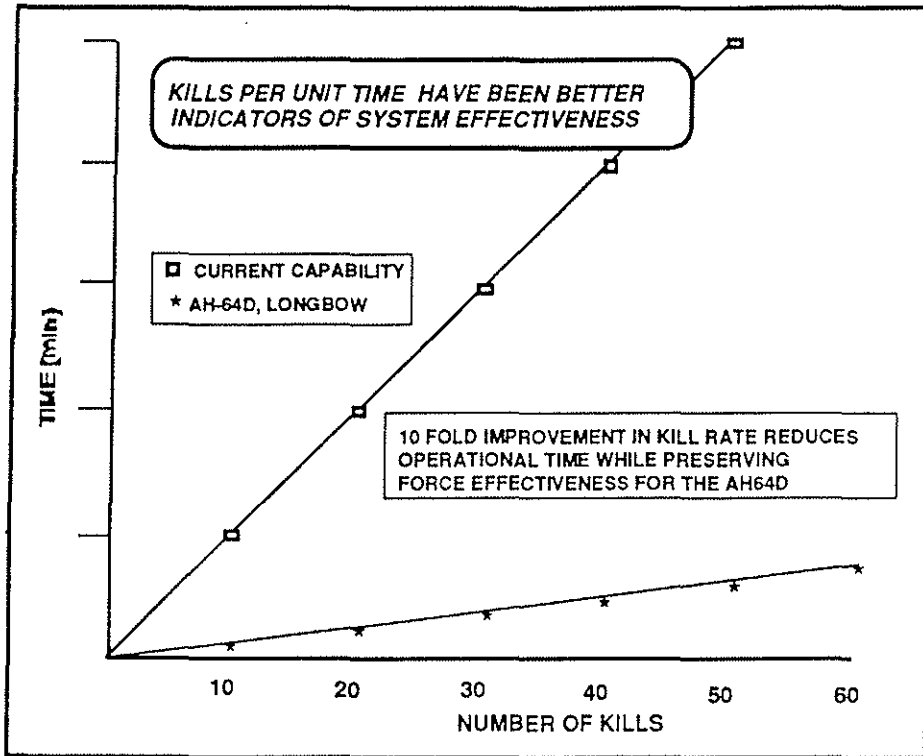

Figure 8. Kill Rate Comparison

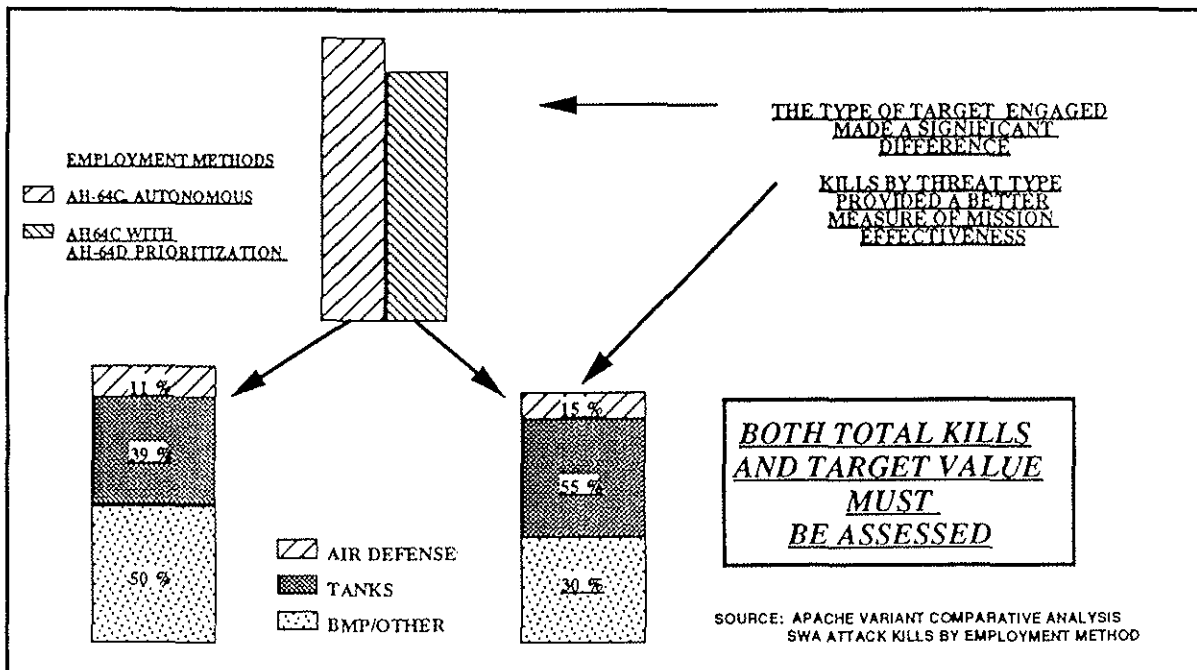

Figure 9. Mission Effectiveness - MOEs

Summary

The AH-64D Longbow represents an awesome increase in capability over the current Apache. Regardless of conditions, the AH-64D Longbow provides the commander the responsiveness to deal with uncertainty. The FCR can acquire targets without regard to most environmental considerations and frees the attack helicopter from the limitations of electro-optical sensors. Further, the multitarget, fire-and-forget, rapid engagement capability minimizes system vulnerability while increasing lethality. These improvements are amplified through the incorporation of increased

battlefield coordination and improved fire distribution and control.

However, as indicated in figure 10, adequate representation of the total system capability in operational effectiveness models has required extensive modifications and upgrades to current models and revision to the "normal" method of employment.

Even with model upgrades, the diverse capability of the AH-64D Longbow still exceeds the capability of most models. In short, as system capability increases, operational analysis difficulty increases and the development of adequate analytical tools lags far behind system development.

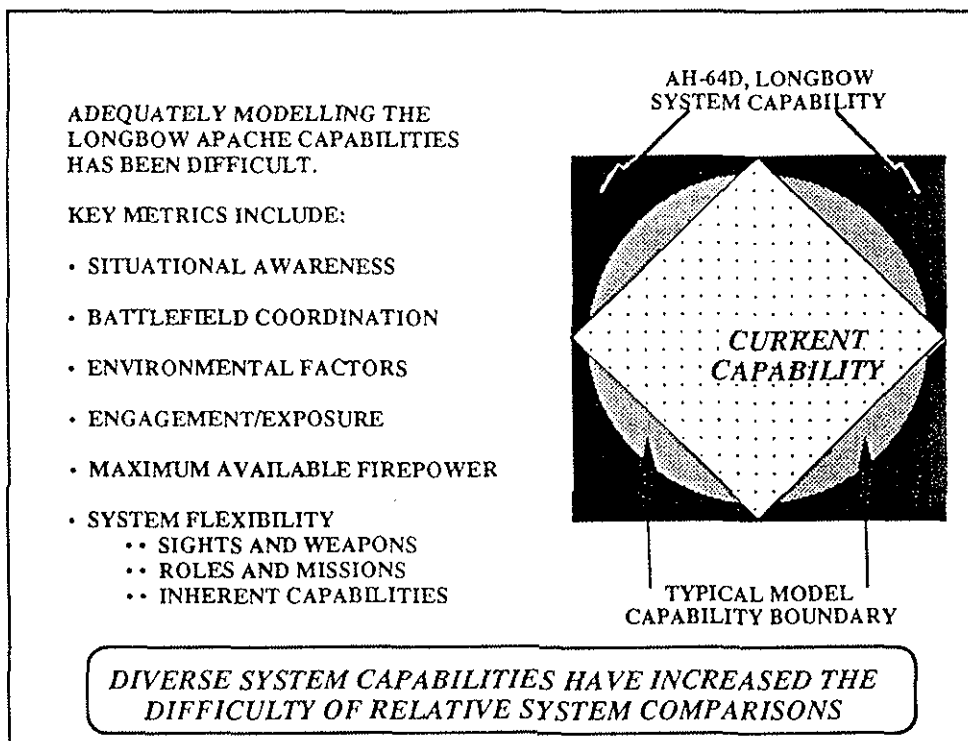

Figure 10. Model Limitations

## References

1. Dimmery, Hugh M., "Apache Modernization Alternatives, Configurations and Attributes," MDHC, 6 August 1991.
2. Dimmery, Hugh M., "Longbow Apache and Airland Battle Future," MDHC, 1 November 1990.
3. Dimmery, Hugh M., "Longbow Apache Operational Effectiveness Briefing, General Managers Update," MSIP220-200, A028-3, 30 April 1991.
4. Dimmery, Hugh M., "Longbow Apache Processor Throughput and Capacity Analysis, Operational Scenario" (draft), MDHC 91-930, 30 September 1991.
5. Dimmery, Hugh M., "Longbow Apache System Effectiveness Briefing, Preliminary Design Review," MDHC MSIP220-200, A028-3, 25 July 1990.
6. Dimmery, Hugh M., "Longbow Apache Target Management and Operational Employment Study Report," MDHC MSIP220-200, A028-3, 27 April 1990.
7. Dimmery, Hugh M., "Sustained Combat Capability of Apache Modernization Options," MDHC, 26 November 1991.
8. Dimmery, Hugh M. and Esquibel, Richy, "Comparative Analysis of Apache Variants (U)," Revision A, MDHC S1008095, CDRL A001-1, 1 November 1991 (SECRET-NOFORN).
9. Dimmery, Hugh M. and Pietrofitti, Anita, "Apache Weaponization Options Study," MDHC, January 1989.
10. Dimmery, Hugh M., et al., "Longbow Apache Operational Feasibility of Remote Acquisition, Hand Over and Blind Launch Study Report (U)," Revision A, MDHC S1008175, MSIP220-200, A028-5, 15 February 1992 (SECRET-NOFORN).
11. Ferrell, Mark D., "Brilliant Weapon - Fighting the Longbow Apache," CGSC, 5 June 1992.
12. Niver, Larry W. and Vanderwart, Geoffrey A., "Force Development Data Collection Simulation Effort for Tactics, Techniques, and Procedures for Longbow Apache," USAAVNC 15 October 1992.
13. Shafer, Jack O., "Longbow's Potential Contribution to Battlefield Intelligence," *Army Aviation*, November 1992.
14. Snider, James R., "AH-64D Longbow Apache and Battlefield Dominance," *Army Aviation*, August/September 1992.
15. Vozzo, Peter A., "How to Fight the Longbow Apache," *Army Aviation*, 30 May 1990.